

Giornale di Didattica e Cultura della Società Chimica Italiana

SPECIALE

C<sub>n</sub>S



LA CHIMICA NELLA SCUOLA

22<sup>nd</sup> ICCECRICE 11<sup>th</sup>

July 15- 20, 2012 ROME, Italy



PROCEEDINGS



For the first time, the two major conferences on Chemical Education respectively by IUPAC and EUCHEMS have joined under the same roof, that of Rome, the eternal City: we were really proud for this.

Chemical Education is constantly undergoing major changes and developments which are also connected to the changing role of Chemistry in Society and the way this science is perceived; as it always more becomes a Science where social, scientific, cultural and didactic aspects interact with each other and with other emerging disciplines such as Museology, Ethics, Communication Science.

We hope that the Rome Conference will be remembered in the future for its contribution to the growth of the quality in Chemical Education. We have worked hard to assemble a high-level scientific program of which the present ACTA as special issue of CNS (Chemistry in the School) are profitable and enjoyable test.

Scientific Committee and Advisory Committee were constituted by prestigious names of Chemical Education such as Peter Childs, Morton Hoffman, Peter Mahaffy, Ilka Parchmann, Uri Zoller, Natalia Tarasova and many others

*The Topics of ICCE ECRICE 2012 are reflected in the contributions here published*

- *Communicating Chemistry*

- Teaching and learning Science and Chemistry
- History and Philosophy of Chemistry in teaching fundamental concepts
- Promoting the Globalization in Chemical Education

- *Didactics of Third Level Chemistry*

- Problem solving in Chemistry: Skill development and assessment
- Applications of Systemic Approach to Teaching and Learning in Chemistry
- Chemistry and Civil Society

- *ICT and Multimedia in Teaching Chemistry*

- The new educational software in Chemistry and science education and ways of improving Chemistry education with computers
- Inquiry-Based Student-Centered Instruction

- *Didactics of Second Level Chemistry*

- Pre-service training of Chemistry teachers
- In-service training of Chemistry teachers
- PCK and Chemistry teaching

- *Laboratory Work in Teaching Chemistry*

- Building active learning environments

Some conclusions can be drawn about the Conference and they will emerge from the communications present in this on line issue of CNS

- Chemical Education has gained during last years a globalized interest and content and this field has stimulated the chemical communities of the third world countries as well as those ones of the industrialized world. This enthusiasm must drive to a continuous increase in international support to the weakest situations
- Laboratory activities are fundamental for Chemical Education, but they need very careful attention to the choice of the proposed experiments
- Chemistry must absolutely not be confused with magic: it is a scientific discipline
- Electronic and informatic support are welcome but they must remain an instrument and not the essence of the chemical education

**Luigi Campanella**  
Conference Chairman

ACREE William E. Jr.	pag. 409	COSTA Mariagrazia	pag. 98
ADAMOV Jasna	pag. 158	CRISTINI Gabriele	pag. 102
ADESOKAN Adejoke	pag. 1	CULLIPHER Steven	pag. 344
ADSMOND Daniel A.	pag. 5	da CRUZ Ingrid F.D.	pag. 130
ADÚRIZ-BRAVO Agustín	pag. 12	DA SILVA Adriano Francisco	pag. 108
AĞLARCI Oya	pag. 18	DA SILVA MESQUITA	pag. 114
AKHMETOV Marat	pag. 22	DALILI Shadi	pag. 352
AKSELA Maija	pag. 388	DEVOTO Valentina	pag. 110
AMADOR-RODRÍGUEZ Rafael	pag. 12	DI FUCCIA David-S.	pag. 331
AMBROGI Paola	pag. 22	DUMITRESCU Crinela	pag. 266
ARAGÃO Susan B. C.	pag. 29	DUQUE Kelly Johanna	pag. 310
ARIZA Yefrin	pag. 12	DUTTON Alice F.	pag. 225
BALZANI Vincenzo	pag. 33	ECHEVERRÍA Agustina R.	pag. 114
BARKE Hans-Dieter	pag. 274	EILKS Ingo	pag. 117
BARKE Hans-Dieter	pag. 149	EILKS Ingo	pag. 62
BARTOSZEWICZ Małgorzata	pag. 40	EPPLE Matthias	pag. 425
BAUER Michael A.	pag. 46	EULER Manfred	pag. 358
BELFORD Robert E.	pag. 46	F. MARAIS	pag. 210
BELLAND Joshua	pag. 225	FAVERO Gabriele	pag. 241
BERGAMINI Enzo	pag. 102	FREYER Katja	pag. 425
BERGS Meike	pag. 51	FUJII Hiroki	pag. 121
BERLEANT Daniel	pag. 46	FUJII Hiroki	pag. 259
BHAT Somashekara	pag. 383	FURIÓ Carles	pag. 306
BHAT Somashekara	pag. 379	GANAJOVÁ Mária	pag. 126
BJÖRKMAN Jaana	pag. 57	GARNIER Rosa Virginia Espinoza	pag. 102
BOSSOLANI KIILL Keila	pag. 314	GARRIDO Fabiola de S.R.G.	pag. 130
BOSSOLANI KIILL Keila	pag. 214	GARRIDO Rodrigo G.	pag. 130
BRERO Gianluca	pag. 102	GEORGE Anna	pag. 232
BUCZEK Irmina	pag. 89	GHIBAUDI Elena	pag. 135
BURMEISTER Mareike	pag. 62	GORGHIU Gabriel	pag. 266
BUSCH Hannah	pag. 68	GORGHIU Laura Monica	pag. 266
CAGLAR Durdane	pag. 179	GRINSHPAN DZMITRY	pag. 323
CALASCIBETTA Franco	pag. 241	GROSS Katharina	pag. 141
CAPITANEO Jefferson Leixas	pag. 108	GUARNA Antonio	pag. 98
CARDOSO Nágilla F.S.	pag. 130	GULIŃSKA Hanna	pag. 145
CARMO Miriam P.	pag. 29	GUO Feihong	pag. 414
CARZEDDA Battistina	pag. 110	HARSCH Nina	pag. 149
CECCHINI Cecilia	pag. 72	HIRAMATSU Atsushi	pag. 121
CHAN K. M.	pag. 75	HOLMES Jon L., MOORE John W.	pag. 46
CHOU Ching-Fen	pag. 202	HORVAT Saša	pag. 158
CHRZANOWSKI Marcin M.	pag. 89	HOSTENBACH Julia	pag. 154
CIEŚLA Paweł	pag. 94	HRIN Tamara	pag. 158
COCCO Ivana	pag. 110	HSU Chuan-Wei	pag. 202
COLLI Laura	pag. 98	HYBELBAUEROVA Simona	pag. 270
COMAI Sara	pag. 102	IKUO Akira	pag. 165
CORDEIRO Márcia Regina	pag. 314	JANASHIA Simon	pag. 168
CORDEIRO Márcia Regina	pag. 214	KABAPINAR Filiz	pag. 18
CORNO Fulvio	pag. 102	KAPANADZE Marika	pag. 168

## IV

KAPANADZE Marika	pag. 117	OHGATA Yusuke	pag. 121
KERMEN Isabelle	pag. 170	OLTEANU Radu Lucian	pag. 266
KHANFOUR-ARMALÉ Rita	pag. 429	OPATOVA Michala	pag. 270
KIM Sung Hoon	pag. 121	OSPINA Natalia	pag. 12
KIMLENKA Iryna	pag. 323	OSSANDÓN Charles Estay	pag. 274
KIMLENKA Iryna	pag. 319	OSTROWSKA Barbara	pag. 89
KNOBLOCH Rebecca	pag. 175	OUARDAOUI Abdelkarim	pag. 237
KOCYIGIT Semra	pag. 179	P.J.J. MARAIS	pag. 210
KOKSAL Ela Ayse	pag. 179	PAIXÃO Fátima	pag. 280
KOMETZ Andreas	pag. 336	PALAZZI Sergio	pag. 284
KÖRBS Caroline	pag. 183	PASCALI Stefano	pag. 102
KUNDUZ Nazan	pag. 327	PÉREZ Alfredo	pag. 306
KUNDUZ Nazan	pag. 187	PRNKA M. Ryan	pag. 225
KUPATADZE Ketevan	pag. 191	RALLE Bernd	pag. 68
LANZANI Guglielmo	pag. 102	REGIS Alberto	pag. 135
LECHOVÁ Petra	pag. 126	REID Norman	pag. 290
LEGROURI Ahmed	pag. 237	REINERS Christiane S.	pag. 339
LERMAN Zafra Margolin	pag. 196	REINERS Christiane S.	pag. 298
LIU Xiuyuan	pag. 414	REINERS Christiane S.	pag. 1
LOU Bih-Show	pag. 202	REINERS Christiane S.	pag. 26
M. POTGIETER	pag. 210	REINERS Christiane S.	pag. 141
MAGNANELLI Elisa	pag. 102	RESNATI Giuseppe	pag. 102
MAHATO Krishna K.	pag. 379	REZNIKOV Ivan	pag. 323
MAHMOOD Khalid	pag. 102	RIZZI Alessandro	pag. 102
MANGANE Destin	pag. 170	ROJE Vibor	pag. 302
MARCONDES Maria E. Ribeiro	pag. 218	ROLETTO Ezio	pag. 135
MARCONDES Maria Eunice R.	pag. 29	RYTAU Aliaksandr	pag. 319
MÁRQUEZ Gloria Sánchez	pag. 310	SÁNCHEZ Gloria	pag. 306
MARTORANO A. de Assis Simone	pag. 218	SANJOSÉ Vicente	pag. 310
MASON Diana	pag. 225	SANTOS Marina Vieira	pag. 314
MASON Diana	pag. 232	SAVITSKAYA Tatsiana	pag. 323
MAZZA Davide	pag. 102	SAVITSKAYA Tatsiana	pag. 319
MAZZOLETTI Giacomo	pag. 102	SCHMIDT Ines	pag. 331
MEREU Maria Cristina	pag. 110	SCHMITT-SODY Barbara	pag. 336
MÉTIOUI Abdeljalil	pag. 399	SCHUMACHER Andrea	pag. 339
MÉTIOUI Abdeljalil	pag. 237	SECKEN Nilgün	pag. 327
METRANGOLO Pierangelo	pag. 102	SECKEN Nilgün	pag. 187
MOLINA Carolina C.	pag. 130	SEGEDINAC Mirjana	pag. 158
MORETTI Giuliano	pag. 241	SEKINE Yoshika	pag. 418
MORPURGO Simone	pag. 241	SEVIAN Hannah	pag. 344
MOSEJTSCHUK Olga	pag. 323	SHELTON G. Robert	pag. 232
NAKAGAWA Tetsuo	pag. 247	SHIOZAKI Eri	pag. 121
NEHRING Andreas	pag. 253	SILVA Lauane M.	pag. 130
NODZYŃSKA Małgorzata	pag. 94	SILVA MARCONDES Lia Mara	pag. 214
NOWAK Kathrin	pag. 253	SKENE Allyson	pag. 352
OGAWA Haruo	pag. 121	SMITH Carla	pag. 232
OGAWA Haruo	pag. 165	SOARES Nyuara Márlon H. F. B.	pag. 114
OGAWA Haruo	pag. 259	STAVROU Dimitrios	pag. 358

# V

STEPHENS Timothy W.	pag. 409	TOMASEVIC Biljana	pag. 393
SUART Rita C.	pag. 29	TOMPERI Päivi	pag. 388
SUMFLETH Elke	pag. 175	TRIVIC Dragica	pag. 393
SUMFLETH Elke	pag. 425	TRUDEL Louis	pag. 399
TALANQUER Vicente	pag. 344	UPMEIER zu BELZEN Annette	pag. 253
TEIXEIRA e COSTA Flora	pag. 362	UTSUMI Ryoichi	pag. 121
TERRANEO Giancarlo	pag. 102	VUKOVIC Ivana	pag. 393
TIEMANN Rüdiger	pag. 404	WALPUSKI Maik	pag. 51
TIEMANN Rüdiger	pag. 57	WALPUSKI Maik	pag. 154
TIEMANN Rüdiger	pag. 183	WALPUSKI Maik	pag. 175
TIEMANN Rüdiger	pag. 253	WEGNER Nina	pag. 404
TIFI Alfredo	pag. 372	WILSON Anastasia	pag. 409
TIFI Alfredo	pag. 368	WU Qing	pag. 414
TIWARI Shailendra Kumar	pag. 383	YASUOKA Takashi	pag. 418
TIWARI Shailendra Kumar	pag. 379		

Giornale di Didattica e Cultura della Società Chimica Italiana

SPECIALE

C<sub>n</sub>S



LA CHIMICA NELLA SCUOLA

22<sup>nd</sup> ICCECRICE 11<sup>th</sup>

July 15- 20, 2012 ROME, Italy



PROCEEDINGS



For the first time, the two major conferences on Chemical Education respectively by IUPAC and EUCHEMS have joined under the same roof, that of Rome, the eternal City: we were really proud for this.

Chemical Education is constantly undergoing major changes and developments which are also connected to the changing role of Chemistry in Society and the way this science is perceived; as it always more becomes a Science where social, scientific, cultural and didactic aspects interact with each other and with other emerging disciplines such as Museology, Ethics, Communication Science.

We hope that the Rome Conference will be remembered in the future for its contribution to the growth of the quality in Chemical Education. We have worked hard to assemble a high-level scientific program of which the present ACTA as special issue of CNS (Chemistry in the School) are profitable and enjoyable test.

Scientific Committee and Advisory Committee were constituted by prestigious names of Chemical Education such as Peter Childs, Morton Hoffman, Peter Mahaffy, Ilka Parchmann, Uri Zoller, Natalia Tarasova and many others

*The Topics of ICCE ECRICE 2012 are reflected in the contributions here published*

- *Communicating Chemistry*

- Teaching and learning Science and Chemistry
- History and Philosophy of Chemistry in teaching fundamental concepts
- Promoting the Globalization in Chemical Education

- *Didactics of Third Level Chemistry*

- Problem solving in Chemistry: Skill development and assessment
- Applications of Systemic Approach to Teaching and Learning in Chemistry
- Chemistry and Civil Society

- *ICT and Multimedia in Teaching Chemistry*

- The new educational software in Chemistry and science education and ways of improving Chemistry education with computers
- Inquiry-Based Student-Centered Instruction

- *Didactics of Second Level Chemistry*

- Pre-service training of Chemistry teachers
- In-service training of Chemistry teachers
- PCK and Chemistry teaching



- *Laboratory Work in Teaching Chemistry*

- Building active learning environments

Some conclusions can be drawn about the Conference and they will emerge from the communications present in this on line issue of CNS

- Chemical Education has gained during last years a globalized interest and content and this field has stimulated the chemical communities of the third world countries as well as those ones of the industrialized world. This enthusiasm must drive to a continuous increase in international support to the weakest situations
- Laboratory activities are fundamental for Chemical Education, but they need very careful attention to the choice of the proposed experiments
- Chemistry must absolutely not be confused with magic: it is a scientific discipline
- Electronic and informatic support are welcome but they must remain an instrument and not the essence of the chemical education

**Luigi Campanella**  
Conference Chairman

ACREE William E. Jr.	pag. 409	COSTA Mariagrazia	pag. 98
ADAMOV Jasna	pag. 158	CRISTINI Gabriele	pag. 102
ADESOKAN Adejoke	pag. 1	CULLIPHER Steven	pag. 344
ADSMOND Daniel A.	pag. 5	da CRUZ Ingrid F.D.	pag. 130
ADÚRIZ-BRAVO Agustín	pag. 12	DA SILVA Adriano Francisco	pag. 108
AĞLARCI Oya	pag. 18	DA SILVA MESQUITA	pag. 114
AKHMETOV Marat	pag. 22	DALILI Shadi	pag. 352
AKSELA Maija	pag. 388	DEVOTO Valentina	pag. 110
AMADOR-RODRÍGUEZ Rafael	pag. 12	DI FUCCIA David-S.	pag. 331
AMBROGI Paola	pag. 22	DUMITRESCU Crinela	pag. 266
ARAGÃO Susan B. C.	pag. 29	DUQUE Kelly Johanna	pag. 310
ARIZA Yefrin	pag. 12	DUTTON Alice F.	pag. 225
BALZANI Vincenzo	pag. 33	ECHEVERRÍA Agustina R.	pag. 114
BARKE Hans-Dieter	pag. 274	EILKS Ingo	pag. 117
BARKE Hans-Dieter	pag. 149	EILKS Ingo	pag. 62
BARTOSZEWICZ Małgorzata	pag. 40	EPPLE Matthias	pag. 425
BAUER Michael A.	pag. 46	EULER Manfred	pag. 358
BELFORD Robert E.	pag. 46	F. MARAIS	pag. 210
BELLAND Joshua	pag. 225	FAVERO Gabriele	pag. 241
BERGAMINI Enzo	pag. 102	FREYER Katja	pag. 425
BERGS Meike	pag. 51	FUJII Hiroki	pag. 121
BERLEANT Daniel	pag. 46	FUJII Hiroki	pag. 259
BHAT Somashekara	pag. 383	FURIÓ Carles	pag. 306
BHAT Somashekara	pag. 379	GANAJOVÁ Mária	pag. 126
BJÖRKMAN Jaana	pag. 57	GARNIER Rosa Virginia Espinoza	pag. 102
BOSSOLANI KIILL Keila	pag. 314	GARRIDO Fabiola de S.R.G.	pag. 130
BOSSOLANI KIILL Keila	pag. 214	GARRIDO Rodrigo G.	pag. 130
BRERO Gianluca	pag. 102	GEORGE Anna	pag. 232
BUCZEK Irmina	pag. 89	GHIBAUDI Elena	pag. 135
BURMEISTER Mareike	pag. 62	GORGHIU Gabriel	pag. 266
BUSCH Hannah	pag. 68	GORGHIU Laura Monica	pag. 266
CAGLAR Durdane	pag. 179	GRINSHPAN Dzmitry	pag. 323
CALASCIBETTA Franco	pag. 241	GROSS Katharina	pag. 141
CAPITANEO Jefferson Leixas	pag. 108	GUARNA Antonio	pag. 98
CARDOSO Nágilla F.S.	pag. 130	GULIŃSKA Hanna	pag. 145
CARMO Miriam P.	pag. 29	GUO Feihong	pag. 414
CARZEDDA Battistina	pag. 110	HARSCH Nina	pag. 149
CECCHINI Cecilia	pag. 72	HIRAMATSU Atsushi	pag. 121
CHAN K. M.	pag. 75	HOLMES Jon L., MOORE John W.	pag. 46
CHOU Ching-Fen	pag. 202	HORVAT Saša	pag. 158
CHRZANOWSKI Marcin M.	pag. 89	HOSTENBACH Julia	pag. 154
CIEŚLA Paweł	pag. 94	HRIN Tamara	pag. 158
COCCO Ivana	pag. 110	HSU Chuan-Wei	pag. 202
COLLI Laura	pag. 98	HYBELBAUEROVA Simona	pag. 270
COMAI Sara	pag. 102	IKUO Akira	pag. 165
CORDEIRO Márcia Regina	pag. 314	JANASHIA Simon	pag. 168
CORDEIRO Márcia Regina	pag. 214	KABAPINAR Filiz	pag. 18
CORNO Fulvio	pag. 102	KAPANADZE Marika	pag. 168

## IV

KAPANADZE Marika	pag. 117	OHGATA Yusuke	pag. 121
KERMEN Isabelle	pag. 170	OLTEANU Radu Lucian	pag. 266
KHANFOUR-ARMALÉ Rita	pag. 429	OPATOVA Michala	pag. 270
KIM Sung Hoon	pag. 121	OSPINA Natalia	pag. 12
KIMLENKA Iryna	pag. 323	OSSANDÓN Charles Estay	pag. 274
KIMLENKA Iryna	pag. 319	OSTROWSKA Barbara	pag. 89
KNOBLOCH Rebecca	pag. 175	OUARDAOUI Abdelkarim	pag. 237
KOCYIGIT Semra	pag. 179	P.J.J. MARAIS	pag. 210
KOKSAL Ela Ayse	pag. 179	PAIXÃO Fátima	pag. 280
KOMETZ Andreas	pag. 336	PALAZZI Sergio	pag. 284
KÖRBS Caroline	pag. 183	PASCALI Stefano	pag. 102
KUNDUZ Nazan	pag. 327	PÉREZ Alfredo	pag. 306
KUNDUZ Nazan	pag. 187	PRNKA M. Ryan	pag. 225
KUPATADZE Ketevan	pag. 191	RALLE Bernd	pag. 68
LANZANI Guglielmo	pag. 102	REGIS Alberto	pag. 135
LECHOVÁ Petra	pag. 126	REID Norman	pag. 290
LEGROURI Ahmed	pag. 237	REINERS Christiane S.	pag. 339
LERMAN Zafra Margolin	pag. 196	REINERS Christiane S.	pag. 298
LIU Xiuyuan	pag. 414	REINERS Christiane S.	pag. 1
LOU Bih-Show	pag. 202	REINERS Christiane S.	pag. 26
M. POTGIETER	pag. 210	REINERS Christiane S.	pag. 141
MAGNANELLI Elisa	pag. 102	RESNATI Giuseppe	pag. 102
MAHATO Krishna K.	pag. 379	REZNIKOV Ivan	pag. 323
MAHMOOD Khalid	pag. 102	RIZZI Alessandro	pag. 102
MANGANE Destin	pag. 170	ROJE Vibor	pag. 302
MARCONDES Maria E. Ribeiro	pag. 218	ROLETTO Ezio	pag. 135
MARCONDES Maria Eunice R.	pag. 29	RYTAU Aliaksandr	pag. 319
MÁRQUEZ Gloria Sánchez	pag. 310	SÁNCHEZ Gloria	pag. 306
MARTORANO A. de Assis Simone	pag. 218	SANJOSÉ Vicente	pag. 310
MASON Diana	pag. 225	SANTOS Marina Vieira	pag. 314
MASON Diana	pag. 232	SAVITSKAYA Tatsiana	pag. 323
MAZZA Davide	pag. 102	SAVITSKAYA Tatsiana	pag. 319
MAZZOLETTI Giacomo	pag. 102	SCHMIDT Ines	pag. 331
MEREU Maria Cristina	pag. 110	SCHMITT-SODY Barbara	pag. 336
MÉTIOUI Abdeljalil	pag. 399	SCHUMACHER Andrea	pag. 339
MÉTIOUI Abdeljalil	pag. 237	SECKEN Nilgün	pag. 327
METRANGOLO Pierangelo	pag. 102	SECKEN Nilgün	pag. 187
MOLINA Carolina C.	pag. 130	SEGEDINAC Mirjana	pag. 158
MORETTI Giuliano	pag. 241	SEKINE Yoshika	pag. 418
MORPURGO Simone	pag. 241	SEVIAN Hannah	pag. 344
MOSEJTSCHUK Olga	pag. 323	SHELTON G. Robert	pag. 232
NAKAGAWA Tetsuo	pag. 247	SHIOZAKI Eri	pag. 121
NEHRING Andreas	pag. 253	SILVA Lauane M.	pag. 130
NODZYŃSKA Małgorzata	pag. 94	SILVA MARCONDES Lia Mara	pag. 214
NOWAK Kathrin	pag. 253	SKENE Allyson	pag. 352
OGAWA Haruo	pag. 121	SMITH Carla	pag. 232
OGAWA Haruo	pag. 165	SOARES Nyuara Márlon H. F. B.	pag. 114
OGAWA Haruo	pag. 259	STAVROU Dimitrios	pag. 358

# V

STEPHENS Timothy W.	pag. 409	TOMASEVIC Biljana	pag. 393
SUART Rita C.	pag. 29	TOMPERI Päivi	pag. 388
SUMFLETH Elke	pag. 175	TRIVIC Dragica	pag. 393
SUMFLETH Elke	pag. 425	TRUDEL Louis	pag. 399
TALANQUER Vicente	pag. 344	UPMEIER zu BELZEN Annette	pag. 253
TEIXEIRA e COSTA Flora	pag. 362	UTSUMI Ryoichi	pag. 121
TERRANEO Giancarlo	pag. 102	VUKOVIC Ivana	pag. 393
TIEMANN Rüdiger	pag. 404	WALPUSKI Maik	pag. 51
TIEMANN Rüdiger	pag. 57	WALPUSKI Maik	pag. 154
TIEMANN Rüdiger	pag. 183	WALPUSKI Maik	pag. 175
TIEMANN Rüdiger	pag. 253	WEGNER Nina	pag. 404
TIFI Alfredo	pag. 372	WILSON Anastasia	pag. 409
TIFI Alfredo	pag. 368	WU Qing	pag. 414
TIWARI Shailendra Kumar	pag. 383	YASUOKA Takashi	pag. 418
TIWARI Shailendra Kumar	pag. 379		

# On the Way to Scientific Inquiry Supporting Hearing-Impaired Learners in Chemistry Classes

Adejoke ADESOKAN, Christiane S. REINERS

*University of Cologne, Institute of Chemistry Education  
Herbert-Lewin-Str. 2, 50931 Cologne/Germany  
adejoke.adesokan@uni-koeln.de*

## Abstract

*This paper deals with the promotion of scientific inquiry for deaf and hard-of-hearing students. The purpose of the project is to create teaching material to advance students' ability to scientific reasoning and working. Results of a preliminary study and information on future steps will be resumed.*

**Keywords:** Students with hearing loss, inclusion, scientific inquiry, language support, visualization

## 1. Introduction

An essential task of teaching chemistry is to introduce students to scientific reasoning and methods of investigation. For this matter doing experiments as well as reporting on experiments and using models to explain scientific phenomena play a decisive role. These aspects are incorporated in the National Educational Standards as 'epistemological competence' [1] and are directed to mainstream schools and special-needs schools equally. Within the framework of this project, initial studies indicate that deaf and hard-of-hearing students need special support for achieving epistemological competence. Although, creating inclusive learning environments has become an increasingly important topic in education, so far, only a few studies exist which consider possibilities to promote students with hearing loss in science classes [2,3]. Therefore, it is necessary to look at the status quo and to think about concepts to advance an understanding of scientific inquiry. Based on the concept of *Participatory Action Research* [4], methods to enhance students' ability to report on experiments and to use models to explain scientific phenomena are tested and evaluated qualitatively [5]. In order to develop teaching material, interviews and survey studies among special education teachers and findings of a video study and participant observation were used. It is anticipated that the outcomes of the project can contribute to inclusive education and to the handling of heterogeneous learning groups.

## 2. Methodology

The aim of the preliminary study is to diagnose learning difficulties and to receive information to create teaching material. In order to do this, questionnaires, interviews, videography and participant observation were chosen as suitable tools.

26 chemistry teachers for deaf and hard-of-hearing students participated in the questionnaire. The survey was conducted in April and November 2011 and contained open questions which deal with issues in teaching chemistry to students with hearing loss.

Afterwards, five teachers were selected and interviewed in October and November 2011. For this purpose, an interview manual was created. The teachers were asked about their education, conditions of the school and how they let students report on experiments.

Subsequent to this, ten chemistry lessons were videotaped and observed from April to June 2012. The study took place in sixth and ninth grade at schools for the deaf and hard-of-hearing. Based on the results of the previous survey, categories were determined and an observation guide for the videography and the participant observation was created. Further categories were added, when new aspects occurred.

To transcribe both interviews and recordings of the lessons, the transcriptions software F5 was applied. In

order to analyze the findings, *Qualitative Content Analysis* [6] and *MAXQDA 10* were used in each investigation.

### 3. Results

In the following section, results of the preliminary study will be presented.

#### 3.1 Questionnaire

For the most part, the results of the questionnaire (figure 1) suggest that the language difficulties of the students are a main issue in chemistry classes, as stated by 19 teachers. Deficiencies in written language cause a lack of understanding of textbooks and difficulties in describing observations. Hence, the teachers are constrained to optimize their teaching material linguistically. In addition, and according to the statements of seven teachers, most of the technical terms used in science do not exist in sign language. It is clear that the absence of subject-specific sign language poses a problem for students who use sign language.

According to nine teachers, the use of models is also a problem. They mentioned that the students have difficulties in understanding and using models to explain experiments. As a result, certain topics will not be discussed or have to be highly simplified. Due to that, the explanation of experiments takes place mostly on the level of phenomena. Although the difficulty in using models is not specific but a general problem [7], it demands specific strategies for students with special needs in terms of language and communication.

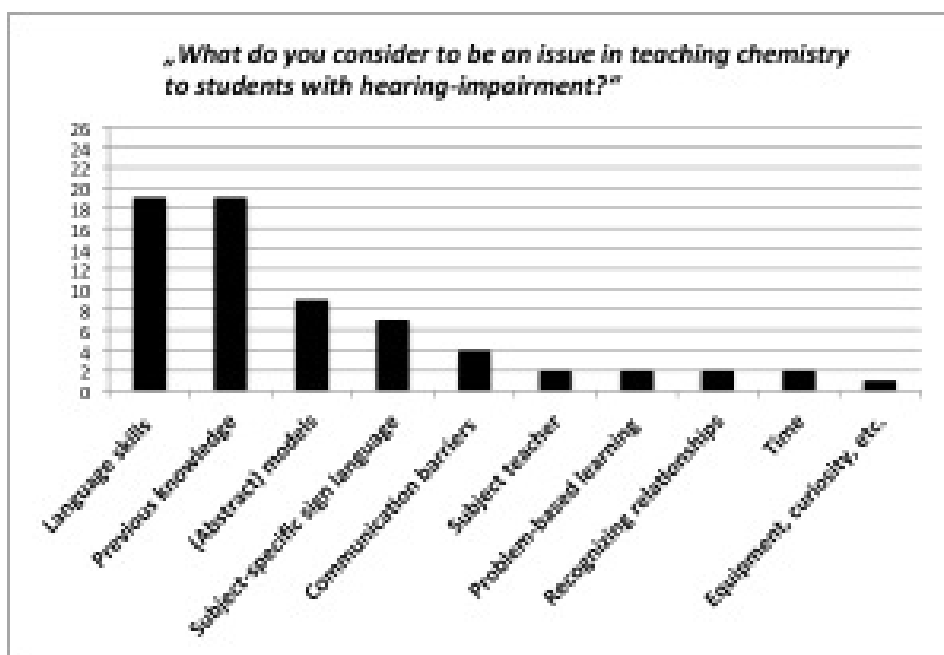


Figure 1 Examples of the results of the questionnaire

From the point of view of two teachers, there are no difficulties on the part of the students. Instead, they see problems on the part of the teachers because of the lack of trained chemistry teachers in special-needs schools. It is probable that most of the participants are teaching chemistry without specific chemistry teacher training.

The results of the questionnaire show a variety of learning difficulties. In order to receive further information, some teachers who had participated in the study were interviewed.

### 3.2 Interviews

The results of the investigation show that none of the participants was a trained chemistry teacher. They all studied special education and subjects like maths, physics and biology. A few of them participated in certificate courses to gain knowledge about chemistry, but most of them were autodidactics. The teachers described the students as heterogenous regarding to forms of communication and language skills. Obviously due to heterogeneity, a high level of flexibility on the part of the teachers is required. But it can be assumed that technical uncertainties may occur because of a lack of teacher training in chemistry. From the point of view of these teachers, problems in reporting on experiments are caused by language difficulties. But they mentioned problems in forming hypotheses and finding explanations as well. Based on the difficulties, the teachers prefer cloze as a tool of reporting on experiments. Other variations are graphical presentations of the experiments or lab reports formulated together at the blackboard. But the students' statements have to be supported linguistically by the teachers quite often.

**Table 1** Proposals of the teachers for developing teaching material

Proposals of the teachers	Aids
Language support	<ul style="list-style-type: none"> <li>- Guided and structured writing</li> <li>- Suggestions on sentence structures</li> <li>- Glossary of technical terms combined with pictures of the items/terms in sign language</li> </ul>
Visualization support	<ul style="list-style-type: none"> <li>- Presenting experiments in pictures</li> <li>- Glossary of technical terms combined with pictures of the items/terms in sign language</li> </ul>
Other	<ul style="list-style-type: none"> <li>- Possibilities of differentiation</li> </ul>

In order to create teaching material, the teachers proposed (table 1) guided and structured writing, suggestions of sentences and the use of a glossary of technical terms. The glossary could contain technical terms, images of items (e.g. laboratory apparatus) and images of important technical terms in sign language, if available. Concerning visualization, the teachers recommended to present the procedure of experiments in pictures. Due to heterogeneity the teachers stated, that the teaching material should also give multiple options for differentiation. All five teachers agreed to a further cooperation.

### 3.3 Video studies and participant observation

Initial results show learning difficulties in terms of language skills, using models, finding explanations and forming hypotheses. Therefore, the statements of the teachers mentioned in previous investigations were confirmed. Apart from the difficulties on the part of the students, technical uncertainties of the teacher were also revealed.

To obtain more information about the possibilities to support the students as well as the teachers, the investigation will be continued.

### 4. Interim conclusion

The results of the preliminary study reveal a variety of difficulties. Thus, different perspectives and approaches arise for the handling of the issue.

This would be beneficial because of the language deficiencies of the students, so they can reconstruct scientific processes by pictures.

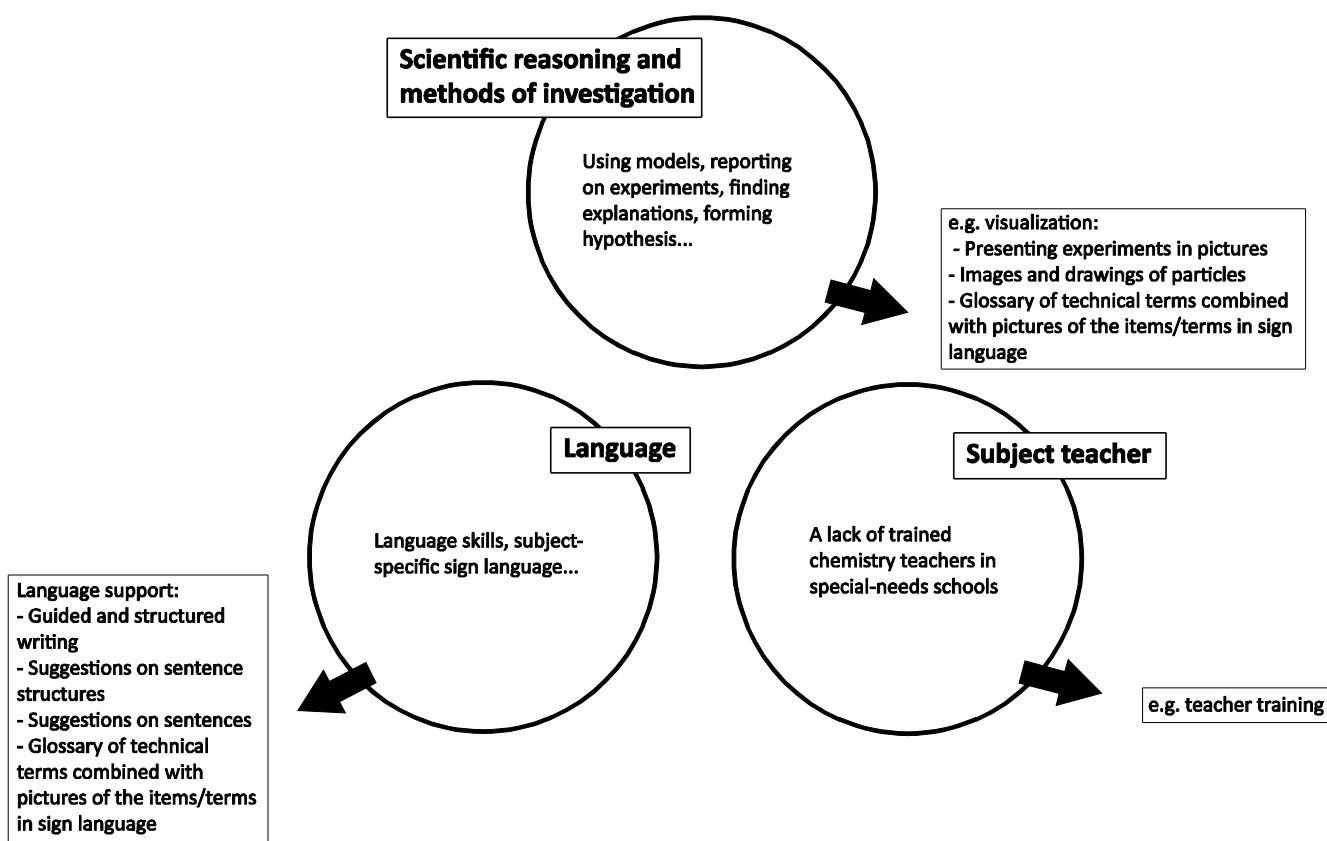


Figure 2 Ideas for developing a problem solving concept

## 5. References

1. I. Parchmann, H. Schecker: Standards and competence models: The German situation. In: P. Nentwig, S. Schanze, D. Waddington (Eds.) Standards in Science Education. Making it Comparable, pp. 147-164. Waxmann, Münster, 2007.
2. P.E. Spencer, M. Marschark, Evidence-based practice in educating deaf and hard-of-hearing students, Oxford University Press, Oxford, New York 2010.
3. B. Schmitt-Sody, A. Kometz: Experimentieren mit Förderschülern im NESSI-Lab. In: S. Bernholt (Ed.) Konzepte fachdidaktischer Strukturierung für den Unterricht, pp. 131-133. LIT, Berlin, Münster, 2012.
4. R. Mc Taggart, Participatory Action Research: International Contexts and Consequences, State University of New York Press, Albany 1997.
5. U. Flick, An Introduction to Qualitative Research, Sage, London, Thousand Oaks, New Delhi, Singapore 2006.
6. P. Mayring, Qualitative Inhaltsanalyse: Grundlagen und Techniken, Beltz, Weinheim, Basel 2010.
7. H.-D. Barke, G. Harsch, S. Schmid, Essentials of Chemical Education, Springer, Berlin 2011.



## Maximizing Scientific Thought through the Design of a Collaborative Research-based Organic Chemistry 2 Laboratory Course

Daniel A. ADSMOND

*Ferris State University, 820 Campus Drive, ASC-3009, Big Rapids, MI 49307-2225 USA  
adsmondd@ferris.edu*

This paper describes the collaborative research-based organic chemistry laboratory course we have developed at Ferris State University and have implemented over the past 10 years. It also explains what we've learned through the experience about engaging students in scientific thought. At Ferris, 200-250 students complete the two-semester organic chemistry sequence each year, approximately half of them bound for pharmacy school. Ten years ago we received a grant from the National Science Foundation Course Curriculum and Laboratory Improvement (CCLI) program to convert the entire Organic Chemistry 2 laboratory course into a collaborative research experience. Since then, roughly 1/3 of our Organic Chemistry 2 laboratory sections have been research-based. Our goal was to create a pedagogical and physical environment in the laboratory that would result in the development of the skills and behaviors inherent to the scientific inquiry process. Specific desired outcomes were that students would 1) learn to design and carry out experiments in response to a research problem, 2) learn to evaluate resultant data and draw their own conclusions, 3) learn to present their own findings and critique classmates' work, and 4) have improved attitudes toward the field of chemistry. A critical component of our course design is a framework that guarantees a maximum of instructor feedback throughout the process. Our two-project model allows students to apply what they learn during the first cycle of planning, synthesis, analysis, evaluation, presentation and critique to a second research project where they refine their skills as they complete a second round of the process.

### Background

From the beginning of my teaching career I had engaged students in a team research project during the final 4-6 weeks of the Organic Chemistry 2 laboratory course. Students carried out a fairly well-defined investigation on a tight time line and summarized their findings in a formal report that was graded at the very end of the semester. While students reportedly enjoyed the experience, I became increasingly frustrated with the lack of scientific thought displayed in their final reports. In 2003 my frustration was translated into action resulting in the changes listed on the right half of Table 1.

Table 1 Research Lab Design Rationale

<b>Research Projects Before 2003</b>	<b>2003 Collaborative Research Lab</b>
Original Research (assigned) Cooperative Team Work (4 students/group) 4-6 weeks in Duration	Original Research (student choice) Cooperative Team Work (4 students/group) Entire Semester of Research
<b>Limitations</b>	<b>Improvements</b>
Old Varian EM390 NMR	FTNMR upgrade by Anasazi Instruments
Data not collected and analyzed in a timely manner	Instrument request sheets and data interpretation sheets required
Little instructor feedback before the end	Feedback given on experimental plans, instrument request sheets, data interpretation sheets, Power Point presentation and portfolio in two different research projects
Little critical evaluation by students	Students evaluate data quality on data interpretation sheets and participate in 2 oral presentation/critique sessions

In the years preceding our NSF grant, several articles were published describing the use and benefits of problem solving pedagogy, [1,3-10] cooperative learning [2,4,11,12] and multi-week research projects [13-16] in the organic chemistry laboratory. A 1996 report to the National Science Foundation "Shaping the Future," [1] outlined new expectations for undergraduate education. The report recommended that science, mathematics, engineering, and technology (SMET) faculty "build into every course inquiry, the process of science, a knowledge of what SMET practitioners do, and the excitement of cutting edge research." Additional recommendations were, "Devise and use pedagogy that develops skills for communication, teamwork, critical thinking, and life-long learning." We sought to incorporate these recommendations into our course. The work of three authors: Kharas, [14] Davis et. al. [16] and Dobrev [13] who introduced a single laboratory research project at the end of the year of organic chemistry laid the groundwork for our new research course design. Our course combines instructor-initiated original research,<sup>14</sup> independent problem-solving emphasis,<sup>13,16</sup> cooperative team work,<sup>16</sup> and a final oral presentation.<sup>13</sup> We added the following components: 1) structured research requirements (experimental plan, instrument request sheets, and data interpretation sheets) to maximize student instructor interaction; 2) a second research project to solidify what students learned in the first project; and 3) peer evaluation of interested in this research because cocrystallization can be used to modify critical properties of drug compounds. Again students submit a plan that is critiqued and returned within a day for modification and resubmission before beginning lab work. During the final week of the course, students present a Power Point p student presentations to engage students in the critique process.

### **Project Design and Experimental Plan**

At Ferris there are thirteen 3-hour lab periods available during a 15-week semester. During the first two weeks students are introduced to the research lab and taught to use the NMR. They form teams of 4 and generate an experimental plan for the first research project. Requirements of the experimental plan include a list of chemicals with quantities, properties and hazards; a glassware and equipment list; a stepwise procedure for synthesis, purification, and analysis; and a weekly schedule. The first research project introduces students to the research process. During the first 3-week project, students investigate the effect of changing a single variable of their choosing on the yield of a reaction selected by the instructor. This first project may or may not involve original research. Experimental plans are submitted to the instructor and returned within 24 hours with suggestions for modifications to be made before the next lab period when the experimental work begins. The final draft of the experimental plan is submitted before beginning lab work the 3<sup>rd</sup> week of the course. Students carry out 4 reactions concurrently and have 3 weeks to synthesize, purify, and analyze their products. During the 6<sup>th</sup> week students present their results and conclusions to their lab section in the form of a Power Point presentation, answer audience questions, and critique each other's work. Students then apply what they have learned about the research process from the first research cycle to a second project that they plan during the 7<sup>th</sup> week of the course and carry out over the following 5 weeks of lab. In recent years the second research project has focused on molecular recognition. Teams typically devise and carry out 20 experiments investigating the influence of various factors on whether two types of compounds will recognize and selectively bind to each other forming a cocrystal. Students design experiments to investigate the effect of molecular substituent, substituent position, solvent, or reactant ratio on the type and stoichiometry of crystalline product obtained. Solution NMR provides information on cocrystal stoichiometry while IR provides information about the specific binding interactions within the crystal. Pre-pharmacy students are particularly interested in this research because cocrystallization can be used to modify critical properties of drug compounds. Again students submit a plan that is critiqued and returned within a day for modification and resubmission before beginning lab work. During the final week of the course, students present a Power Point presentation on their 2<sup>nd</sup> research project and most participate in a poster session open to all lab sections and the general public.

### **Instrument Request Sheets**

In general, chemists select the analytical technique that will best answer the question(s) they have formulated. In contrast, a majority of our students, if allowed to, will collect analytical data without ever considering whether the data will answer the question they need to answer. In short, student behavior is often guided not by questions to be answered but rather by tasks to be completed. To train students to behave more like chemists and to avoid the time wasted in collecting meaningless data, students in the research lab course are required to explain to the instructor specifically what will be learned by collecting the desired data. In preparation for collection of analytical data, students complete an instrument request sheet showing structures of expected products, solvents, and possible impurities. Students explain why their chosen analytical method is better than other available techniques. Students requesting NMR usage are required to list the chemical shifts, splitting, and integrations expected for their product and possible impurities. For IR, students describe expected peaks and tell specifically what will be learned from their presence or absence. Students also explain what the data will NOT show. Before collecting the data, students give an oral explanation of what they have written on the instrument request sheet to an instructor who signs off on it.

### **Data Interpretation Sheets**

Chemists often interpret their analytical data immediately after it is collected to determine if the experiment was a success. If nothing else, chemists examine the data quality to make sure it is sufficient for answering the question at hand. Students, on the other hand, often blindly collect data, planning to interpret it at a later date. Often they don't check for proper integration and the presence of TMS in an NMR or whether there are any significant peaks in the IR other than those for mineral oil. In order to encourage a somewhat timely analysis of the data, students within a week of collecting the data are required to complete a data interpretation sheet explaining what they know about the quality of the data and explaining exactly what the data tells them about the purity of the sample and the amounts of the various contaminants. Again, the student explains the sheet to an instructor and receives feedback as needed.

The structure provided by the instrument request and data interpretation sheets ensures that the data hasn't been mindlessly collected, that its quality has been properly assessed, and that it has been accurately interpreted. This structure not only serves to develop the habits of mindful data collection and timely analysis, but also increases the value of the data set and consequently the viability of the conclusions drawn. Largely because of the high number of experiments completed in the molecular recognition project, each student typically goes through the instrument request - data interpretation process 6-10 times during the semester.

### **Oral Presentation/Critique Sessions**

Each team delivers a 10-minute oral presentation to the other students in their lab section at the conclusion of each research project. Teams explain the question they were investigating and their hypothesis; summarize their procedure and the data collected; and explain their conclusions. Students in the audience are required to write down one question during each presentation and ask a minimum of one question during the lab period. This first presentation session gives the instructor an opportunity to model critical analysis of data and conclusions through questioning the presenters. Many of the instructor questions are designed to get students to reflect on the real meaning of their data and the validity of their conclusions. For each presentation, students in the audience complete a grading rubric rating the presenters in eight categories. This serves as a tool to focus their assessment of the presenters and to catalyze improvement in their 2<sup>nd</sup> presentation.

A majority of the students participate in a public poster session at the end of the 2<sup>nd</sup> research project. There they compare and discuss their data and conclusions with students in other lab sections. They also gain experience explaining their research to people spanning a wide range of backgrounds.

## Grading

The laboratory grade is determined by the identification of an NMR unknown (8%), the 3-week research project (27%), the 5-week research project (54%), and participation in the Q&A session and critique of the presenters (11%). Each project grade is composed of two parts: the Power Point presentation evaluation (70%) and a portfolio evaluation (30%). The portfolio contains both drafts of the experimental plan, all instrument request sheets, all data along with data interpretation sheets, laboratory notes, and a hard copy of the Power Point slide presentation. In order to encourage all team members to do their share of work, each student is given 16 points to divide up between the four team members for their relative contributions in each of 8 different areas. The points are collated and the score is used as a multiplier of the team score. Upon completion of the first research project, students are given their group score, their multiplier and their individual score. Also, if there is a consensus among the group that a student did less or more than his share in a particular area, he is provided with that feedback.

## Results

### *Pre/Post Test Results*

During the first two years of the pilot project, students' learning was evaluated by a pre/post test that we devised. Students were tested on their ability to understand variables in a chemical reaction, choose methods of purification and analysis, evaluate spectral data quality, and evaluate conclusions. The test was given to students in 4 different lab sections: 3 research labs and 1 control lab (a lab of more traditional structure, but with similar learning objectives.) Average pre to post test improvement for the three research labs was 24% compared to 22% in the control lab. In the research labs we saw a 22% improvement in questions related to our first desired outcome on designing and carrying out experiments and a 29% improvement on our second desired outcome on evaluating data and drawing conclusions.

### *Student Survey Results*

Students were provided with an anonymous survey with 3 free response questions and 7 Likert scale questions during each of the two years of the pilot and during each of the past two years. Five of the Likert scale questions addressed areas of change as a result of the Organic Chemistry 2 lab experience and two questions focused on preferred student groupings for lab work and preferred lab focus. 36 (92%) of the students responded in 2003; 34 (46%) in 2004; 55 (85%) in 2011; and 46 (82%) in 2012.

In the first free response question we asked, "What were the *most important things you gained or learned* from the group research projects?" Representative responses from six of the 2012 students provided below reflect learning about various aspects of the research process as well as gaining skills in communication and team work.

"I learned how to work in groups effectively. I also gained the ability to interpret data such as IR and NMR to a huge degree."

"I learned a lot about planning out lab work. I also learned a lot about working in a group and being patient with other people."

"I learned how to analyze results much better than I ever could before. It really helped me to question the data that I collected and pushed me to figure out exactly why my data turned out the way it did."

"Ability to lead a project, proficiency in running and interpreting IR, confidence in lab, ability to explain research to someone who has little background knowledge of chemistry."

"I learned how to plan and execute a research project. I learned the importance of planning and thinking carefully about every aspect of the experiment."

"That I love lab and research."

We also asked, "What did you find *most stimulating* about the group research projects?" The top 6 responses of the 46 respondents in 2012 are as follows with frequency of response in parentheses: problem solving/critical thinking (11); the flexibility/freedom/independence (9); experiencing the research process (7); discovery (6); presentation (5) and the cocrystallization topic (5).

In the third free response question we asked, "What were the *most negative aspects* for you of the group research projects?" Table 2 compares the top responses from the 70 students in 2003 & 2004 to the

responses on the same issues from 46 students in 2012. Ways in which we addressed some of the issues are included in the table as well.

Table 2 Negatives from Students' Perspective and How They Were Addressed

<b>Top responses in 2003 &amp; 2004 (% of students with issue in 03 &amp; 04)</b>	<b>How Issue has been addressed (% of students with issue in 2012)</b>
We had to wait for instructor assistance (13)	Hired student lab assistants (0)
We received too little guidance (16)	Initial guidance has increased (2)
The lab was at too high of a level (9)	Replaced conceptually difficult chemistry (0)
We didn't have appropriate background (7)	We can fill in gaps for a few students (0)
Team members didn't contribute equally (11)	Partner evaluations affect grades (13)
Too great of a time investment (44)	Equal to traditional labs, not addressed (20)

Results of the five Likert scale questions addressing perceived personal change as a result of the Organic Chemistry 2 laboratory experience are summarized in Table 3. Table 3 condenses the greatly increased and slightly increased categories of the 5 point Likert scale as well as condensing the slightly decreased and greatly decreased categories.

Table 3 Responses to Student Survey Questions about Change as a Result of the Organic Chemistry 2 Lab Experience (percentages in parentheses represent decreases)

Area of Change	2003 student responses	2011 & 12 student responses
Confidence in lab skills	77% increased (11%)	97% increased (02%)
Confidence in problem solving skills	64% increased (06%)	89% increased (01%)
Ability to interpret results	89% increased (03%)	95% increased (01%)
Interest in scientific research	50% increased (28%)	85% increased (02%)
Attitude toward chemistry	44% improved (39%)	87% improved (04%)

### Presentation Assessment

We have found that student questions during the first presentation session are largely of a clarification nature. While some students begin to question whether the data presented actually supports the conclusions, a majority of such questions are initiated by the instructor. During the second round of presentations at the end of the semester a noticeable change is observed in the ability of students to critically analyze the meaning of their own data as well as the data and conclusions of others.

### Discussion

Overall the pre/post test results and the student survey results point to significant positive movement toward the objectives. In 2012, students found the most stimulating aspect of the experience to be the problem solving/critical thinking component. Also in 2012, 97% of the students reported increased confidence in lab skills, 89% increased confidence in problem solving skills, and 95% increased ability to interpret data. The first free response question points to group work, interpreting data, and planning lab work among the most important things gained or learned. The 3<sup>rd</sup> free response question, however, unearthed some underlying issues in 2003. The first four issues listed in Table 2 are closely related to each other and can be summarized as follows. The students didn't understand enough of the chemistry that they were carrying out to trouble shoot on their own and couldn't readily get the help they needed. We suspected this was a major contributor to the decreased interest in scientific research reported by 28% of

the 2003 students and a poorer attitude toward chemistry reported by 39%, as seen in Table 3. Two major factors come into play here: the high student/instructor ratio and the difficulty of the chemistry. In analyzing the 2004 surveys, which gave similar results, we were able to make a direct connection between the negatively responding students and the projects that they were involved with. The chemistry in these projects was more challenging, products were difficult to isolate and it was difficult even for the instructor to draw conclusions from the data collected. Even while team teaching, the instructor supervising the more challenging projects had trouble keeping up with the needs of the students. When we applied what we learned from the surveys in the following years, the first 4 complaints on Table 2 and the poor attitude displayed in Table 3 all but disappeared.

We have been impressed over the years by the depth of thought demonstrated by the type of questions students ask each other and by the responses during the final presentation/critique session. The instructor questions during the first presentation session generally catch the students off guard as they have, at that point in the course, put little critical thought into whether their experimental results really justify their conclusions. The first Q&A session sets the standard for the second research project and serves as a catalyst for more critical examination of experimental design, data, and conclusions.

Often a pedagogical innovation requires a surge of time, energy, and creativity that cannot be maintained indefinitely. In order to maintain the research lab over the years, we've had to address several issues of sustainability. The biggest threat to the research lab upon expiration of the grant period was the return to the normal laboratory student/instructor ratio of 24/1. One instructor can't keep up with student questions, instrument requests, and data interpretations while still addressing instrument issues that arise. Fortunately we have been able to hire students who have successfully completed the research lab as teaching assistants. The extra instructor in the lab makes it possible to address the high number of required student/instructor interactions.

Another sustainability challenge is the need for continuous generation of ideas for new research projects. One of the ways that we maintain a flow of new ideas is to maintain a spread sheet of all of the results of the experiments completed by previous students. Students and faculty can peruse the spreadsheet, which now consists of results from over 3000 cocrystallization experiments, and can build on the findings of previous students with new ideas.

## Conclusions

In short, we've found that the success of our collaborative research-based laboratory course rests on a few simple principles. Maximizing feedback throughout the process is probably the most important component of our lab design. When students carry out research over an extended period of time, continuous intentional instructor feedback greatly increases the learning and the understanding of the research process. We found out the hard way that it only takes one or two frustrating factors to sour students' attitudes toward the research experience. Keeping the chemistry simple helped the students to more fully understand what they were doing in lab. This greatly improved students' attitudes toward the experience and consequently their learning. Formalizing the critique process forces the students to look at each part of their work critically and teaches them how to critically evaluate the work of others. It is a stretch to carry out two research projects in a single semester, but the experience of learning to critically evaluate each other's work during the first oral presentation session contributes greatly to the ability of teams to effectively design, carry out, and assess the results from experiments in the 2<sup>nd</sup> project. We have learned the importance of balancing freedom and structure. Students enjoy the freedom to design their own experiments and set their own schedule, but in the end, the structure is essential for meeting educational objectives. Pre/post test data, student surveys, student presentations, and student critiques of each others' work all point to significant progress toward our four objectives. Also in line with the "Shaping the Future" recommendations of using pedagogy that develops skills for communication and teamwork, our students report gains in teamwork and presentation skills among the most important things gained through the experience.

**Acknowledgments:** Peter Balanda and David Frank were co-PIs on the NSF grant. Balanda taught research labs in 2003 and 2004. Frank provided expertise in development of the survey tool and the pre/post test as well as in the analysis of the results. Frank has participated in the presentation sessions though out the entire 10-year history of the research lab course.

## References Cited

1. George, M. D. *et. al.*, "Shaping the Future: A report to the National Science Foundation" (NSF96-139) <http://www.her.nsf.gov/her/duo/documents/review/96139/start.htm>, 1996.
2. Herron, J. D., *The Chemistry Classroom Formulas for Successful Teaching*, American Chemical Society, Washington, D. C., 1996, p54.
3. Gallet, C., "Problem-Solving Teaching in the Chemistry Laboratory: Leaving the Cooks...", *J. Chem. Ed.*, **75** (1998), 72.
4. Neeland, E. G., "An Introductory Organic Lab for the Problem-Solving Lab Approach", *J. Chem. Ed.*, **76** (1999), 230.
5. Shadwick, S. R.; Mohan, R. S., "The Discovery-Oriented Approach to Organic Chemistry 2. Selectivity in Alcohol Oxidation", *J. Chem. Ed.*, **76** (1999), 1121.
6. Davis, D. S.; Moore, D. E., "Incorporation of FT-NMR throughout the Chemistry Curriculum", *J. Chem. Ed.*, **76** (1999), 1617.
7. Sgariglia, E. A.; Schopp, R.; Gavardinas, K.; Mohan, R. S., "The Discovery-Oriented Approach to Organic Chemistry. 3. Rearrangement of cis- and trans-Stilbene Oxides with Boron Trifluoride Etherate", *J. Chem. Ed.*, **77** (2000), 79.
8. Cooley, J. H., "A Problem-Solving Approach To Teaching Organic Laboratory", *J. Chem. Ed.*, **68** (1991), 503.
9. Pickering, M., "The Puzzle-Oriented Organic Laboratory", *J. Chem. Ed.*, **68** (1991), 232.
10. Hathaway, B. A., "An Aldol Condensation Experiment Using a Number of Aldehydes and Ketones", *J. Chem. Ed.*, **64** (1987), 367.
11. Hass, M. A., "Student-Directed Learning in the Organic Chemistry Laboratory", *J. Chem. Ed.*, **77** (2000), 1035.
12. Brown, L. M.; Blackburn, E. V., "Teaching Introductory Organic Chemistry: A Problem-Solving and Collaborative-Learning Approach", *J. Chem. Ed.*, **76** (1999), 1104.
13. Dobrev, A. A., "Course Thesis as End of the Laboratory Experimental Program", *J. Chem. Ed.*, **73** (1996), 856.
14. Kharas, G. B., "A New Investigative Sophomore Organic Laboratory Involving Individual Research Projects", *J. Chem. Ed.*, **74** (1997), 829.
15. Fife, W. K., "The Organic Chemistry Laboratory A problem-oriented program", *J. Chem. Ed.*, **45** (1968), 416.
16. Davis, D. S.; Hargrove, R. J.; Hugdahl, J. D., "A Research-Based Sophomore Organic Chemistry Laboratory", *J. Chem. Ed.*, **76** (1999), 1127.

## **‘Interpretive frameworks’ Supporting argumentation processes in pre-service chemistry teachers: the role of meta-theoretical ideas**

**Agustín ADÚRIZ-BRAVO, Natalia OSPINA, Rafael AMADOR-RODRÍGUEZ, Yefrin ARIZA**

*CeFIEC-Instituto de Investigaciones Centro de Formación e Investigación en Enseñanza de las Ciencias,  
Facultad de Ciencias Exactas y Naturales, Universidad de Buenos Aires.*

*CeFIEC, 2° Piso, Pabellón 2, Ciudad Universitaria, Avenida Intendente Güiraldes 2160, (C1428EGA)  
Ciudad Autónoma de Buenos Aires, Argentina*

*E-mail (first, correspondence author): aadurizbravo@cefiec.fcen.uba.ar*

*Phone & fax: (54 11) 45 76 33 31*

### **Abstract**

*In this paper, analysis on part of the data corpus generated in an exploratory investigation is presented. In the piece of research that we conducted, two ‘interpretative frameworks’ were proposed to account for the ‘fundamentals’ selected and applied by chemistry teachers when involved in argumentation processes. Those interpretive frameworks are instructional ideas and common-sense ideas. To this, a meta-theoretical perspective of analysis was added, considering the ideas about science employed by teachers when arguing. The methodology of data collection included: 1. participation of a group of pre-service teachers in a video game with science content; 2. application of post-game survey and semi-structured interview; 3. preliminary analysis of the results obtained (via constant comparative method) in terms of the original interpretive frameworks. In this paper, we discuss and re-interpret selected fragments from the interviews conducted; we focus on a third interpretive framework, of meta-theoretical character. This addition allowed us to characterise teachers’ argumentation processes through two ‘key ideas’ coming from philosophical reflection on science; such ideas can be labelled as representation (the way in which science ‘captures’ reality with symbolic artifacts), and correspondence (the relationship between what science ‘predicates’ and reality). Results of our re-interpretation led us to consider that chemistry teachers often rely on these two meta-theoretical ideas when developing argumentative processes, since they talk about the complex, interactive relationships between symbolic entities and the phenomena modelled.*

**Keywords:** argumentation processes, interpretive frameworks, meta-theoretical perspective, philosophy of science, realism.

### **1. Introduction**

Characterising argumentation processes in educational contexts requires the adoption of specific theoretical frameworks that would allow the demarcation of methodological aspects, i.e., what will be considered and how, and what will be disregarded. In this sense, a number of investigations in didactics of science (i.e., science education as a research discipline) are available [1-3] in which it is apparent that the theoretical approach *determines* the methodological approach.

In this paper we are interested in the generation of argumentation processes among teachers, within a learning environment that implies interaction with a technological tool: a video-game, Kokori<sup>1</sup>, that is designed as a set of seven ‘missions’ of a microscopic spaceship inside an animal cell.

The choose of a technological tool was made with the aim of critically investigating the use of such kind of resources in real classroom settings; specifically, in a classroom of pre-service chemistry teacher education. In this respect, we follow Inés Dussel [4], who claims that school and its functions are being re-defined at the beginning of the 21st century, and that educational action within the schools should be conducted taking into account the variety of modes of communication and dissemination currently availa-

1. The videogame Kokori was developed by the Universidad Santo Tomás in Chile (see [www.kokori.cl](http://www.kokori.cl)). It simulates an environment representing the interior of an animal cell; it inspects cell functions related to key biological processes in different situations: the attack of a bacterium, a virus invasion, shortage of energy, etc.



ble. Nevertheless, we consider that the incorporation of those modes cannot be done without critical reflection on the ways in which they affect classroom dynamics and represent an actual improvement on more traditional classrooms.

Our focus has then been the argumentation processes produced following the interaction of two groups of student-teachers with the video-game Kokori as an innovative tool. We have interviewed the participating teachers after their interaction with the video-game; the context in which they ‘played’, and in which data was collected, was designed with the aim of generating *dialogical processes of argumentation* between each teacher and the researcher (Natalia Ospina).

One of the premises of our piece of research has been that, during the development of argumentation processes, student-teachers base their arguments on a variety of what we call *interpretive frameworks*. In the preliminary categorisation of the data obtained from the interviews, we initially proposed two interpretive frameworks: *instructional ideas* and *common-sense ideas*. Further analyses have led us to propose a new set of categories, coming from a meta-theoretical perspective; those categories are the object of this paper.

## 2. Theoretical framework

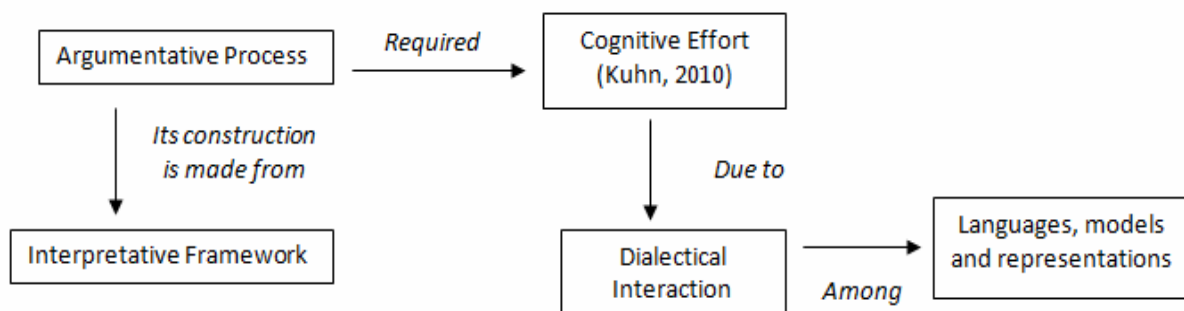
This section is devoted to describing the theoretico-methodological frameworks for our work with pre-service chemistry teachers around argumentation. Firstly, we define our stance on argumentation processes, then we introduce the meta-theoretical perspective.

### 2.1. A characterisation of argumentation processes

We understand the generation of dialogical arguments as a *process*, as depicted by Deanna Kuhn [5]. Arguing understood as dialogue demands cognitive effort, since participants need to process each other’s contributions and anticipate their own response in the dialogical situation [6].

In chemistry teaching, the aforementioned argumentation processes can be fostered in real classroom contexts, starting from the presentation of some phenomena that allow proposing and discussing two positions that need to be defended and supported by students. The selected phenomenon should be ‘reachable’ from students’ conceptual capacities, so that argumentation does not present itself as the mere repetition of an oral or written text that only complies with the constraint of having a ‘sound’ structure from the point of view of argumentation theory. If this requirement of meaningfulness of the phenomena to be argued on is fulfilled, rich, complex argumentative processes can be found even from common sense (i.e., without the introduction of scientific ideas).

In Figure 1, we have called *interpretive framework* to the set of referential aspects that guide an argumentation process in a distinct setting (scientists’ science or school science). The interpretive framework would more or less play the role of what Stephen Toulmin [7] calls *warrant* and *backing*; we have created this construct to acknowledge that the substantive content of an argument is always construed from a distinct and organised set of beliefs and premises. In our preliminary analyses of data obtained with two populations of pre-service chemistry teachers, we found that their arguments to account for complex cellular processes could be seen as based on common-sense ideas (i.e., ideas coming from their everyday experience) or on instructional ideas –whether these would be accepted scientific ideas or misconceptions.



**Figure 1.** A characterisation of argumentation processes. Adapted from [8].

## 2.2. Meta-theoretical analysis of arguments

As we have stated in the introduction, revisiting data of our piece of research convinced us of the need to acknowledge the possibility that a ‘meta-theoretical’ interpretive framework exists as support of some of the argumentation processes that we were studying. Such acknowledgement brought up the need to characterise this third framework through reflection on the *nature of science*. Such reflection is done from the discipline of philosophy of science.

Accordingly, this section intends to present the most relevant characteristics of our positioning in the philosophy of science. Our meta-theoretical choices permitted the construction of the ‘key’ philosophical ideas on science and chemistry with which student-teachers arguments were examined.

Among the variety of philosophical schools that have emerged in the last century (e.g., logical positivism, received view, historicism, evolutionism, naturalised epistemology) the current *semantic* –or *representational*, or *model-based*– view of scientific theories provides, according to some specialists, refined meta-scientific tools to think about the structure, dynamics and products of the scientific enterprise [9-10]. The semantic view is represented by authors such as Fred Suppe, Bas van Fraassen, Ronald Giere, and those inscribed in the so-called meta-theoretical structuralism.

The semantic view gives a secondary role to the formal and linguistic aspects of a scientific theory, which were emphasised by the axiomatic view that reigned in the first half of the 20th century. ‘Semanticism’ puts in the centre of epistemological analysis the construct of ‘scientific model’ [9-12].

The core notion of the semantic view is that a scientific theory is best characterised when it is portrayed as a set of models, rather than as a set of axioms (the classical ‘scientific laws’). Such notion is recovered in the philosophy of science [cf., 11-12] and in didactics of science, in the very few cases in which this school is used [cf., 13-14]. In general, members of the semantic view agree, to different degrees, with the following statements:

1. The most basic component that constitutes the identity of a theory is a *class* of models.
2. When characterising a theory, part of the task consists in identifying the phenomena that the theory is aimed to account for.
3. A theory defines its models with the pretension of adequately representing the aforementioned phenomena; thus, there exists a substantive relationship between theoretical models and empirical systems.

Starting from the most fundamental statements of the semantic view, which we have here only very superficially presented, we identified and characterised two key meta-theoretical ideas –*correspondence* and *representation*– that we find extremely fruitful in didactics of science. In the next section we go deeper into these latter ideas.

## 3. Key ideas from the philosophy of science

Key ideas can be characterised as those structuring ideas that allow organising content from the philosophy of science with didactical purposes [15]. We recognise in these key ideas structuring, analytical, and evaluative purposes. These key ideas have been extensively examined by different epistemological schools.

### 3.1. Approach to the ideas of correspondence and representation

For the purpose of the present paper, we have concentrated on the key ideas of correspondence and representation, which are closely linked to the issue of *realism* [15]. We will now briefly define these two ideas having in mind their utility for our work in an educational context.

**Correspondence** refers to the way in which scientific theories relate to the items of reality they intend to account for. From a semanticist point of view, and particularly using Giere’s [16] ideas, the relationship between theoretical models and the real world is a relationship of *similarity*. In this sense, theoretical models ‘resemble’ reality without capturing it completely. The degree of resemblance of models and real systems can be specified in what Giere calls ‘theoretical hypotheses’.

**Representation** refers to the way in which items of reality are ‘captured’ with symbolic means, i.e., represented ‘in absentia’ for scientific purposes. Although this idea was tackled in different ways by the

philosophical schools that preceded the semantic view, semanticism has treated in depth the operation of representation in the dynamics of science. In this sense, semanticists consider that the real world is represented through abstract, non-linguistic, mainly imaginistic, models, which are then defined or described using different semiotic tools.

### 3.2. Operationalisation of the key ideas for our investigation

Based on the previous characterisation, we have reconstructed these two ideas so that they can fit the context of our investigation and function as criteria of analysis in order to study the arguments of the teachers under study.

Correspondence is here applied to describe the multiple ways in which teachers relate the theoretical entities that they know from biology and chemistry and the different elements of real living beings that they recognise in the Kokori environment. This would be done through the use of what are usually called ‘theoretical terms’, which function as ‘bridges’ in teachers’ identification of the represented features and transformation of those feature employing their knowledge about them.

Representation is here applied to describe the way in which teachers decode the symbolic processes of mediation between the objects and phenomena that they know in biology and their stylised representations in the Kokori environment.

## 4. Methodology

The piece of research from which this paper stems is of qualitative nature. In it, we intended to generate theoretical criteria to analyse the arguments contained in the survey questionnaires and semi-structured interviews with the teachers we were working with. The methods of data analysis used in our research are based on *symbolic interactionism* [17], and are usually referred to as *constant comparative analysis*. This kind of analysis allows the construction of categories ‘from’ raw data and the development of diverse hypotheses during the different phases of research.

The population of our study is constituted by teachers (N=35) in their pre-service education in two higher level institutions in Colombia and Argentina. These teachers were surveyed and interviewed after their interaction with the video-game Kokori. The questionnaire and the interview script related to structural and functional aspects of the video-game and to the cellular processes that were supposedly represented therein.

Our first categorisation of some selected fragments of the interviews allowed us to situate teachers’ arguments as based on two main interpretive frameworks: they either support their inferences in their everyday knowledge, or they make explicit reference to ‘academic’ knowledge that they have learnt. As we have stated, the latter, which we have called instructional ideas, may or may not correspond to accepted disciplinary knowledge from chemistry and biology.

After this first categorisation, we approached data with the hypothesis that teachers also often talked about meta-theoretical issues. Instead of completely ‘surrogating’ the real cell with the analogue provided by Kokori, they went back and forth connecting these two realms, and extensively commenting on the advantages and disadvantages that arose from the work with the model. Accordingly, we proposed the existence of a third interpretive framework, and we tried to inspect teachers’ utterances from a meta-theoretical point of view. We found recurrences that, in our opinion, could be captured with the key ideas of correspondence and rationality. The following section is devoted to presenting some results of this new analytic approach.

## 5. Teachers’ arguments and the meta-theoretical interpretive framework

In this section we provide a few fragments of the teachers’ responses to survey and interview that we have selected as the most significant to support our introduction of the new interpretive framework. In our opinion, the excerpts –when revisited from a meta-theoretical point of view– provide evidence of teachers’ concerns about the use of models. The ideas of correspondence and representation have proved powerful to look into these excerpts in order to find their some hints around teachers’ perspectives on the nature of science. Using the excerpts, we exemplify the kind of analysis we have performed on the data.

Pre-service Teacher C: [...] it helped me to see that [the cell] is three-dimensional, this is what I most, what I most noticed, and how it works; you can well see that the cell is a unit in fact [...].

Pre-service Teacher D: [...] lysosomes performed a function, but it wasn't what it [really] does, because it traps a... something virtual, and this is really not in the cell... [but then] what is real and what is not real [...].

Pre-service Teacher A: [...] it helps to see what is more structural, the structural cell, and furthermore to erase a little bit the imaginary that one has about the cell –plane [...].

Pre-service Teacher B: [...] exactly, that's it, like the grape that I take from the cluster and the raisin, that's the comparison that I make for you between the living cell and the one that is frozen [...].

The combined use of the constant comparative analysis and our system of epistemological categories allowed us to go again through the corpus of data in order to construct a second 'layer' of interpretation. This new codification can be understood as a 'mapping' of our 'contextualised reconstruction' of the ideas of correspondence and representation (section 3.2) onto some of the core elements in teachers' statements. Mapping is done through the identification of some linguistic 'indicators' in those statements, which we now highlight (using italics):

**Indicators for correspondence:**

- You can well *see* that the cell is a unit *in fact*<sup>2</sup>.
- It was [...] something *virtual*.
- What is *real* and what is *not real*.

**Indicators for representation:**

- It helps to *see*.
- *Erase* a little bit the *imaginary* that one has about the cell.
- *Like* the grape [...], that's the *comparison*.

The mapping that we have explified here relies on linguistic elements (modals and metaphors) that are traditionally linked to the epistemological topic of realism. This gives plausibility to our re-interpretation of teachers' arguments in terms of the meta-theoretical framework.

**6. Final remarks**

In our opinion, considering argumentation processes as grounded on some justifying elements, which we have here called 'interpretative frameworks', adds to the the discussion about the crucial aspects that guide school scientific argumentation. Our proposal in this paper focused on one of these frameworks, constituted of meta-theoretical elements. By looking into the arguments built by our students-teachers, it becomes apparent that one of their concerns revolves around the nature of science. Concretely, they think and talk about how a model-representation (the Kokori 'cell') stands for a real system (an animal cell). According to our interpretation, teachers' responses: 1. explicitly establish relationships between real entities and the symbolic elements that are used to model those entities; and 2. pose questions concerning the extent of these relationships.

We consider that further, more refined, studies of the interpretive frameworks of meta-theoretical nature that support teachers' argumentation processes could lead to new insights on the ideas about science that they maintain.

2. n Spanish, the teacher uses the expresión 'en realidad' (lit., 'in reality'), which might be translated as 'really', 'as a matter of fact', 'after all'.

## 7. References

1. S. Erduran, M.P. Jiménez-Aleixandre (Eds.), *Argumentation in science education: Perspectives from classroom-based research*, Springer Academic Publishers, Dordrecht, 2008.
2. L. Bricker, P. Bell, Conceptualizations of argumentation from science studies and the learning sciences and their implications for the practices of science education, *Sci Ed*, 2009, 92, pp. 473-498.
3. V. Sampson, D. Clark, Assessment of the ways students generate arguments in science education: Current perspectives and recommendations for future directions, *Sci Ed*, 2008, 92, pp. 447-472.
4. I. Dussel, *Aprender y enseñar en la cultura digital*, Fundación Santillana, Buenos Aires, 2011.
5. D. Kuhn, Teaching and learning science as an argument, *Sci Ed*, 2010, 94, pp. 810-824.
6. F. Van Eemeren, R. Grootendorst, F. Snoeck, *Argumentación: Análisis, evaluación, presentación*, Biblos, Buenos Aires, 2006.
7. S. Toulmin, *The uses of argument*, Cambridge University Press, Cambridge, 1958.
8. N. Ospina, L. Galagovsky, G. Merino, *I Congreso Latinoamericano de Investigación en Didáctica de las Ciencias Experimentales*, Santiago de Chile, July 2012, n/pp.
9. Y. Ariza, A., Adúriz-Bravo, La nueva filosofía de la ciencia y la concepción semántica de las científicas en la didáctica de las ciencias naturales, *Ed en Cienc Mat y Exp*, 2012, 2, pp 55-66.
10. J.A. Díez, P. Lorenzano, *Desarrollos actuales de la metateoría estructuralista: Problemas y discusiones*, Universidad Nacional de Quilmes, Bernal, 2002.
11. J.A. Díez, C.U. Moulines, *Fundamentos de filosofía de la ciencia*, Ariel, Barcelona, 1999.
12. A. Chakravarty, The semantic or model-theoretic view of theories and scientific realism, *Synthese*, 2001, 127, pp. 325-345.
13. M. Develaki, The model-based view of scientific theories and the structuring of school science programmes, *Sci & Ed*, 2007, 16, pp. 725-749.
14. A. Adúriz-Bravo, A 'semantic' view of scientific models for science education, *Sci Ed*, in press.
15. A. Adúriz-Bravo, *Integración de la epistemología en la formación del profesorado de ciencias*, Universitat Autònoma de Barcelona, Bellaterra, 2001.
16. R. Giere, *Explaining science: A cognitive approach*, University of Chicago Press, Chicago, 1988.
17. C.A. Sandoval, *Investigación cualitativa*, ICFES, Bogotá, 2002.

## The Effect of Discovery Learning Method on High School Students' Understanding of Daily Life Chemistry Concepts

Oya AĞLARCI, Filiz KABAPINAR

Marmara University, Atatürk Faculty of Education, Department of Chemistry Education, İstanbul, Turkey  
E-mail: oya.aglarci@marmara.edu.tr telephone number: +905057552386

### Abstract

*The purpose of the study is to investigate the effectiveness of discovery learning model on high school students' understanding of some daily life chemistry concepts such as organic and inorganic compounds, soaps, detergents and other cleaning agents. A quasi experimental design was used in order to examine the effectiveness of the intervention designed and the results were compared with the results of the conventional teaching that is constructivist in nature. An open ended questionnaire was designed so as to uncover students' ideas related to the nature of organic and inorganic compounds used in daily life. Students' written responses to the questionnaire were analyzed in ideographic terms. The findings indicated the feasibility of the teaching daily life chemistry concepts based on discovery learning theory.*

**Keywords:** Constructivism, Discovery Learning Method, Chemistry Education, Misconceptions, Chemistry in Daily Life

### Introduction

Constructivism has been the underpinning philosophy for many current reform efforts in education [4]. Educational reform in Turkey launched in 2004 has emphasized constructivist instructional approaches leaving the knowledge transfer view behind. Traditional learning model suggests the transmission of knowledge from teacher to learner whereas constructivist model gives value to learner's construction of knowledge from their experiences; making meaning from the interaction between existing knowledge or beliefs and new ideas [5]. Discovery learning requires active involvement of the learner [3]. Hammer [2] defined discovery learning as designed activities to engage students in inquiry guided by teacher through materials that they discover. Discovery learning also states that student finds discovery more meaningful than just learning about the subject. Joolingen [3] emphasized the importance of cognitive tools as instruments in learning environments for performing discovery skills. Thus, it is a suitable way to practice constructivist philosophy in class and it is often used in teaching skills via inquiry rather than scientific concepts. According to Castronova [1], teachers thought that discovery learning cannot be used in learning science concepts. However, concepts can be taught in the line of discovery learning principles. Students can be provided a range of examples that are representative of the key concept to be learnt. They examine the examples and find out the basic properties of the concept. Thus, they discover the meaning of that concept. During this personal discovery process, students are able to compare and contrast illustrative examples and generalize it toward a general meaning. In this way, they also use the scientific process skills such as comparing, classifying, making a decision via inductive reasoning [2].

Even though the constructivist paradigm has been adopted in educational arena, Turkish teachers have a tendency to transmit knowledge to their students in "Daily Life Chemistry" unit concepts. This unit involves the concepts of organic and inorganic compounds, soaps, detergents and other cleaning agents. The reasoning behind this tendency might be the appearance of these concepts in chemistry textbooks. They are presented in the form of knowledge to be transferred. However, the concepts aforementioned can be thought via instruction based on discovery learning where problems are posed to encourage investigations and examples are presented for promoting inductive reasoning.

## Purpose of the Study

The purpose of the study is to investigate the effectiveness of discovery learning model on high school students' understanding of the nature and properties of organic and inorganic compounds used in daily life. In this respect, the research questions can be stated as:

1. Is there a difference between the conventional teaching method and discovery learning model on students' understanding of "Daily Life Chemistry" unit concepts?
2. What are high school students' (conventional teaching method group) ideas concerning the organic and inorganic compounds?
3. What are high school students' (discovery learning model group) ideas concerning the organic and inorganic compounds?

## Method

The study was planned in the light of constructivist/interpretive paradigm and a quasi experimental design was benefited in order to examine the effectiveness of the teaching intervention designed. The results were compared with those obtained from the conventional teaching method. The teaching intervention was put into practice in a first year upper grade secondary (grade 9) Turkish class. Forty four high school students (21 female and 23 male) participated in the study. An open-ended questionnaire concerning the nature and properties of organic and inorganic compounds used in daily life was designed. Some of the questions asked students to explain a range of concepts such organic compounds, inorganic compounds, whereas some of them asked students to distinguish the hydrophilic and hydrophobic parts of the molecules and to define polar and apolar compounds. Also, in the questions, high school students were asked to write down the open formula, hydrophilic and hydrophobic parts of some organic compounds such as propane, methanol and benzene. After piloting the questions, the questionnaire was distributed to students in both groups (experimental and control) before and after the instruction carried out. The participants' open ended responses to the questionnaire were analyzed in ideographic terms and the statistical relationship was investigated by nonparametric test.

The study is designed on the bases of socio-cultural constructivist view. In line with this view, discovery learning method was also benefited in designing the teaching intervention. Teaching activities involved daily-life stories, case studies and primary and secondary sources to help students construct their own knowledge. In the first activity, the students worked in pairs and examined examples of organic and inorganic compounds. They were asked to figure out the differences between the two and define the two term. This was followed by questions where they had to classify given compounds as organic and inorganic. In the second activity, students were presented organic compounds with their names. They were then asked to find out how organic compounds were named. Afterwards, they examined presentation of some properties (such as melting point, bonding type, water solubility) of organic and inorganic compounds. Having completed the aforementioned conceptual part, students were asked some questions about cleaning agents, they designed open-ended experiments and tested their hypotheses. These questions were:

- 1-Is there a difference between soap and detergent on cleaning grease spot?
  - 2-Do you use hot or cold water when you are doing the laundry? Which one clean faster?
  - 3-Do you use powder detergent or liquid detergent? Compare the cleaning rate of the two cleaning agents.
- At completion of the inquiries, students designed posters where they explained the cleaning mechanisms of some cleaning agents. The teaching intervention was lasted for four weeks in total in accordance with the existing curriculum. Both of the groups received instruction by the same teacher. The effectiveness of the teaching intervention was taken to mean to enrich scientificity of students' explanations.

## Findings

### The effectiveness of the discovery learning method on students' understanding

The students were administered the same questionnaire prior to and after the instruction so as to know the status of the two groups prior to the teaching. In this way, it was possible to know whether the experimental and control groups were equivalent (i.e. equivalent only in terms of the variable focused on by the pre questionnaire) at the outset of the study. The responses of the two groups were similar in nature. The results of the Mann Whitney U test (as the test distribution is not normal) carried out showed that there was no significant difference between the two groups of students indeed in terms of the grades obtained the questionnaires. It can be said that the groups are equivalent to each other prior to instruction statistically.

The same questionnaire was used again to trace the development of the students' understandings. The findings were analyzed by SPSS programme. Mann Whitney U test results regarding post test scores of groups can be seen in Table 1.

**Table 1:** Mann Whitney U test results of the groups' understanding of unit concepts

Groups	N	Mean rank	Rank total	U	p
Conventional Teaching Method Group	22	21.64	476.00	223	0.665
Discovery Learning Method Group	22	23.36	514.00		

It can be said that the teaching intervention based on discovery learning was as successful as the conventional teaching in helping students to gain knowledge concerning the daily life chemistry concepts. This means that students who were not imparted knowledge by the teacher could construct the knowledge related to the concepts tested.

The two groups of students were similar statistically. Yet, they differ in their performances in individual questions. For instance, they differed in acquisition of their definitions of organic and inorganic compounds. The results of the analyses of these questions can be seen in Table 2 and 3.

**Table 2:** The Conventional Teaching Method Group Students' definitions related to organic and inorganic compounds

	Organic	Inorganic
<b>Correct definition</b>	12	11
<b>Inadequate definition</b>	-	-
<b>False definition</b>	8	9
<b>Uncodeable/No answer</b>	2	2
<b>Total</b>	<b>22</b>	<b>22</b>

Table 2 shows that 12 students out of 22 (54%) defined correctly organic compounds and 11 students out of 22 (50%) gave the correct definition of the inorganic compounds. The number of students who incorrectly define the two concepts (8, 9) is noteworthy. These students (%36, %41) failed to learn the definition of the concepts.

**Table 3:** The Discovery Learning Method Group Students' definitions related to organic and inorganic compounds

	Organic	Inorganic
<b>Correct definition</b>	16	17
<b>Inadequate definition</b>	4	4
<b>False definition</b>	2	1
<b>Uncodeable/No answer</b>	-	-
<b>Total</b>	<b>22</b>	<b>22</b>



Table 3 shows that 16 students out of 22 (72%) defined correctly organic compounds and 17 students out of 22 (77%) gave the correct definition of the inorganic compounds. Even though there is no significant difference between the mean ranks of the two groups, it can be seen from the tables that the ratio of discovery learning group who gave the correct definition is higher than the conventional teaching group.

### Results and Conclusions

The findings indicated the feasibility of the teaching daily life chemistry concepts based on discovery learning theory. They also revealed that the teaching intervention based on discovery learning was as successful as the conventional teaching in helping students to gain knowledge concerning the daily life chemistry concepts. The discovery learning method can be used as an alternative teaching intervention in teaching the science concepts even if they seem to be knowledge-based in nature.

### References

- J. A. Castronova, Action Research Exchange, 2002, [http://teach.valdosta.edu/are/Litreviews/vol11no1/castronova\\_litr.pdf](http://teach.valdosta.edu/are/Litreviews/vol11no1/castronova_litr.pdf), Accessed 06.05.2012
- D. Hammer, Cognition and Instruction, 1997, 15 (4), 485-529.
- W. Van. Joolingen, International Journal of Artificial Intelligence in Education, 1999, 10, 385-397.
- K. Tobin, & D. Tippins, The practice of constructivism in education, 1993, 3-21.
- M. E. WALSH, & P. W. AIRASIAN, THE EDUCATION DIGEST, 1997, 62 (8), 62-69.

## How to Improve Learning Activity of Students in Chemistry Education

**Marat AKHMETOV**

*Head of Science Education Department  
Teachers' Professional Skills Advancement Institute, Russia  
81, 12 Sentyabrya str., Ulyanovsk, 432048  
E-mail: maratak@ya.ru - Telephone number: +7-9033381057*

### **Abstract**

*Today learning activity of students becomes a great significance for success of both education and life. There are at least two concepts of learning activity. One of these concepts considers learning activity as characteristic of personality. The second concept considers that learning activity is an action. Russian researches T.Shamova and G.Shchukina supposed what learning activity as characteristic of personality includes three levels. First level is a reproducing activity. If students have some knowledge of chemistry they can achieve second level was named interpretative activity. Third level is creative activity.*

*Researchers in chemical education consider mainly learning activity as action. Many methods of stimulation learning activity have been developed, but the problem of improving learning activity as characteristic of personality in chemical education has not been resolved.*

*Theoretical and experimental research allowed us to develop the pedagogical model for improving learning activity of students. Reproducing activity requires stimulating motives for learning. Motives «interestingly» and «usefully» are very helpful for this aim. Improving of interpretative activity requires that a success in learning was achieved. The concept of cognitive strategies is very useful to improve a creative activity. There is difference between terms «cognitive strategy» and «method». «Method» is a particular way of doing something. «Cognitive strategy» is a mental technology of thinking.*

*We tried to help all teachers realize the model. We had formulated 7 simple rules with the aim of improving learning activity of students.*

**Key words:** chemistry, learning, activity, students, to improve

### **Learning activity**

There are at least two concepts of learning activity. One of these concepts considers learning activity as learning work. Russian researches T.Shamova and G.Shchukina supposed what learning activity as characteristic of personality includes three levels. First level is a reproducing activity. If students have some knowledge of chemistry they can achieve second level – interpretative activity. Third level is creative activity. Learning activity as characteristic of a student may be improved in education.

Reproducing activity students begin to study chemistry. They haven't a positive experience of solving problems. Their motives for learning depend on teaching methods. To take an interest in chemistry they need a fun. These students have not ability to study without teachers' help.

Interpretative activity students have already some knowledge of chemistry. They can take a part in heuristic education, solve chemical problems. These students want to understand essence of chemical phenomena. They want to master new skills. These students know that problems solving gives a feeling of success, a feeling of bliss. They have a some clash of wills to study. These students want to have a learning success, therefore they try to overcome learning difficulties.

Creative activity students have high level of learning interest. They can understand essence of chemical phenomenon. These students can find new way to solve problems. They have a high clash of wills and a persistence. These students can organize and can plan their process of learning chemistry.

Researchers developed various methods for improve learning activity. These methods are: problems solving; learning games; a chemical experiment; to improve a motivation; a positive emotional education; an entertaining learning; a heuristic methods of teaching; to use a fiction; using of an information on interactions between chemistry and human life; prepare a situation of learning success.

At the same time a way of improving learning activity as characteristic of personality at teaching chemistry was not developed.

### **The model for improving of learning activity in chemistry education**

We created this model on the basis of A. Maslow concept of self-actualization. From our point of view human motives for an activity includes learning motives. According to the model teachers should choose methods of teaching that depending on learning activity level. Development of students' reproducing activity requires stimulating motives for learning. Motives «interestingly» and «usefully» are very helpful for this aim. The development reproducing activity need using such methods as chemical experiments, visualization, educational games, an using a fiction, art, film clips, history of chemistry, the media, interactions between chemistry and life.

Improving of interpretative activity requires that a success in learning was achieved. Students need an opportunity to choose a kind of activity, methods for solving problem. Gradual development of chemical concepts, problems solving are conditions for learning success. Chemical problems need to be set in the context of a human life and the real importance of a feeling or experience. Metaphors have a great importance to many students. Metaphors help students to understood difficult chemical concepts. Repetitive feelings about learning success improves learning activity and clash of wills.

Improving of creative activity requires a lot knowledge has gone into making a learning success. This level students need careful thought about their thinking. A reflection, understanding of own style of thinking helps students to find a creative way to solving problems. These level students need other advanced pupils, teamwork in a classroom, overcoming of learning difficulties. Project activity, learning research, participation in chemical competitions need creative activity of students.

The concept of cognitive strategies is very useful to improve a creative activity. There is difference between «cognitive strategy» and «method». «Method» is a particular way of doing something. «Cognitive strategy» is a mental technology of thinking.

### **Seven rules for improving learning activity of students**

All teachers want their students have good knowledge and skills. Learning activity of students should improve for this purpose. Teaching methods need to conforms with level of students' learning activities. It is hard to choose best teaching methods for many teachers, because they have not enough knowledge of psychology and didactic methods. We are suggested only seven easy rules for chemistry teachers.

#### **Rule №1 «Firstly, students need to take an interest in chemistry, and just then they'll wish to study chemistry»**

*No strong activity,  
without personal interest.  
Lev Tolstoy*

In the Russian fairytale that reflects the wisdom of the people, it had told: «Firstly, feed me, give me a drink, lay me to sleep, and just then - ask me!». Motives are the basis of some activity. It is important that these motives were internal. For improving students' interest on chemistry lessons teachers should use: chemical experiments; educational games; teamwork; information about the history of chemistry; interconnection between chemistry and art (poetry, prose, fragments of movie, painting, sculpture), other subjects (physics, mathematics, biology and others), the media (TV, radio, Internet, magazines, newspapers); an interconnection chemistry with human life.

#### **Rule №2 «Firstly, students need to learn substances, secondly, they'll want to study their structures»**

*From living perception to an abstract thought,  
and from it to a practice  
V. Lenin*

Substances and their properties are the subject of chemistry. Firstly, students need to learn substances, secondly, they'll want to study their structures, chemical formulas and chemical equations. This rule applies to both the method of constructing an initial course of chemistry, and the method of constructing each individual topic.

If we ask students: "Where do we find chemical elements?" We can hear the answer: «In the Periodic Table!». This answer is the indirect indication that the rule №2 has not been realized. The expected response can be like this: «Chemical elements exist all around us and into our body. All material world, including you and me are made from tiny particles called chemical elements. More than 100 chemical elements well known».

### **Rule №3 «Firstly, students need a practical experience, secondly, they can learn a theory»**

*Grau, teurer Freund, ist alle Theorie,  
Und grün des Lebens goldner Baum  
Johann Wolfgang von Goethe*

What majority of students prefer, to learn theory or practice? We think that the answer is clear. A theory is a scientifically valid way to solve problems of human life. Theory as an instrument to solve practical problems is significant and full of meaning. But a theory without practice hasn't significance, not understandable for students. They need to encounter life's problems then this theory will be important, easy to understand.

### **Rule №4 «Interconnect chemistry with human life»**

Teachers need to use information from other areas of life: a history of chemistry; an art (a poetry, a prose, the cinema, painting, sculpture); daily life (health, a household, professions); media (TV, a radio, the Internet, newspapers, journals); other subjects (biology, geography, physics, literature, mathematics and others).

Example of chemical problem: «Alchemists didn't know about the chemical composition of substances. They used words instead of chemical formulas and equations. Goethe in "Faust" wrote an example of the alchemical procedures:

Da ward ein roter Leu, ein kühner Freier,  
Im lauen Bad der Lilie vermählt,  
Und beide dann mit offnem Flammenfeuer  
Aus einem Brautgemach ins andere gequält.

We can suppose that the «roter Leu» is a red mercuric oxide (HgO), and the «der Lilie» is hydrochloric acid (HCl).

- 1) Write the equation of chemical reaction between "roter Leu" and "der Lilie".
- 2) What mass of «roter Leu» will react with 100 g 36,5% "der Lilie" solution?

### **Rule №5 «Learn chemistry deeply»**

*It is necessary to combine a hearing  
and a vision, a talk with activities of hands  
Comenius*

A teacher shouldn't begin a new topic until students achieved success in learning. It is necessary to ensure that students: in their thoughts have seen substances, and their structure, be able to demonstrate structures of substances using models and formulas, know how to describe their internal representations by words. Visual, auditory, kinesthetic, digital styles of representation should integrate into a common image. Students should use these styles to think.

### **Rule №6 «Students should use chemical calculations to understand chemical formulas and chemical equations»**

Chemistry is fundamental science. Chemistry is the scientific study of the structure of substances, but formulas and equations have great importance for understanding chemistry. If students hadn't understood what is "chemical formula", "chemical equation", purpose of teaching chemistry is not achieved.

Students need to use mathematical calculations for the understanding of the concepts of "chemical formula" and "chemical equation". Difficulty of chemical calculations should be increased gradually.

### **Rule №7 «Prepare a success in learning of chemistry»**

If teachers have performed six previous rules students will be ready to self education. Teacher should explain easy way of solving problems to students. Because of students can use different cognitive strategies, they will any way for solving chemical problems or offer on their own. It may happen that a one student will choose a one method of solution, and an other student will choose a second way, and a third student will propose his own method. In this case students can discuss various methods of solving chemical problems without a teacher. A content of the course can be depends on what the students would like to study. Following teaching methods can be used:

- an heuristic conversation;
- a best choice content of course, methods and ways to solve chemical problems;
- educational research activities;
- self reflection of cognitive styles and cognitive strategies;
- training students for competitions and conferences;
- solving chemical problems should interacts with problems of human life.

### **Conclusion**

Our experimental research showed that using of these rules increases learning activity of students. For example we found that chemical problems with a life context had increased the number of participants in the regional Chemistry Competitions for 2 years in more than 2 times.

### **References**

- G. Shchukina, *Intensification of students' learning activity*. M.: Prosveschenie, 1979  
 T. Shamova, *Intensification of students' learning*, M.: Pedagogika, 1982.

## Chemistry competence based curricula: a comparative analysis of the implementation in Germany and Italy

Paola AMBROGI<sup>1</sup>, Christiane S. REINERS<sup>2</sup>

*1 ITI "L. Nobili" Via Makallè 10, 42121 Reggio Emilia, Italy;  
2 Institute of Chemistry Education, University of Cologne, Germany  
Email: paola.ambrogi@unimore.it*

### Abstract

*The introduction of chemistry competences based curricula at compulsory school level in Italy lead to make a comparison with Germany, whose theoretical framework has similarities with the Italian one but according to international surveys results in better learning outcomes. The hypothesis is that, despite the similarities in the theoretical framework, the implementations in the two countries are different. A comparative analysis of the implementations has been done using the German outline as a lens through which to observe the Italian one. The analysis highlighted that, whereas the German framework comprehends detailed description of the areas of competences and learning outcomes, the Italian framework and guidelines are holistic, and that the area of the competence epistemology is less addressed in Italy. The results support the importance of a systematic description of the area of competence epistemology to enhance this area in the Italian school.*

**Keywords:** chemistry curricula, competences.

### Theoretical background

The introduction of Chemistry Competence-Based Curricula (CCBC) in Italy, at compulsory school level, initiated an analysis of the documents in the countries in order to have a larger vision of how competence-based curricula were interpreted and implemented. It is important to go beyond the national vision and interpretation, which can be narrowed and biased by the local mental habit and traditions, to have a larger perspective that enables to individuate the points of strength, to be stressed, and those of weakness, to be recovered.

The analysis of the documents that introduced the competence-based curricula in the educational systems revealed that German theoretical framework has similarities with the Italian one, but has different results concerning learning outcomes in science on the bases of the international PISA surveys [1].

The hypothesis is that, despite the similarities in the general theoretical frameworks, the implementations in the two countries are different, and this led to make a comparison to find out what makes the differences and how can the Italian teachers be supported to improve students' learning outcomes.

### Design of the study and Methods

To carry out the comparison between the CCBC implementation in the two countries the study encompasses two steps: a) the comparison of the theoretical frameworks for CCBC; and b) the investigation of their practical implementation.

a) The comparison between the theoretical frameworks involved the analysis of the Italian and German documents for the CCBC implementation, which are the Italian National Educative Norms [2] and Guidelines for CCBC [3] and the German National Educative Standards for Chemistry [4, 5]. The well organized structure of the German areas of competences has been used as a lens through which observe the Italian one.

b) The investigation of the practical implementation was based on the information collected by using a questionnaire, which was created by the authors. It was pilot tested. To validate the results the observation of two teachers, one in Italy and one in Germany, was added. The observations were documented. The investigations have been carried out in the Italian region Emilia Romagna, and in the German state North Rhine Westphalia. The Italian teachers engaged in the study teach at Technical Institute, while the German at Gesamtschule. The choice of those types of schools allowed the comparison between

situations in which chemistry is taught at grade 9-10 (the two last year of compulsory school) as a separate subject for a comparable amount of periods per week (three hours in Italy and two in Germany). The investigation had been conducted in the school year 2010/2011.

## Results

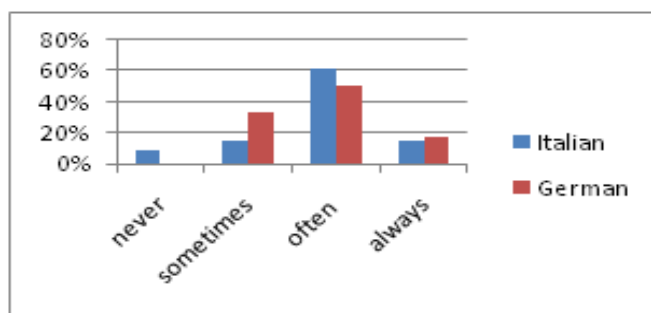
The comparison of the theoretical frameworks showed that the German standards refer to Weinert's definition of competence [4, 6], which encompasses the cognitive, practical and social spheres, and the same spheres are addressed by the Italian definition of competences that refers to the one released in the European Qualification Framework [2, 7]. The definitions of competence used by the two countries overlap broadly, but the comparison of the guideline for the implementation showed differences. In Italy the descriptions of the guidelines are based on knowledge and skills and refer almost exclusively to the cognitive area. Furthermore, the learning outcomes are generic. Whereas the German competences refer both to knowledge and skills: they are interrelated, and the operative description of the learning outcome standards is present for the different areas of competence. The comparison showed that the Italian guidelines are holistic whereas the German are systemic and refer directly to the areas of competence.

The investigation of the practical implementation showed differences between the approaches of the Italian and German teachers to CCBC especially concerning the competence area of epistemology. Following are reported three Lickert items from the questionnaire and their answers. The items are part of those that investigate the competence area of epistemology. Figure 1, 2, and 3 show the results of three interrelated questions that investigate if the teacher offers students opportunity to carry out experiment and to design them. The questions are respectively: 1-Do you make students carry out experiments?; 2-Do you make students design experiments? And 3- Do you make students carry out experiments designed by them? Both the Italian and German teachers let students carry out experiments but unlike the German teachers more than 50% of the Italian never make students design experiments, and what is worse, 77% never make students carry out experiments designed by them. The German teachers provide students with more opportunity to regard the experiments not only as a hands-on training activity but also as a mind-on activity. This fosters the students' capability to formulate hypothesis and to test them, and with it addressing some important aspects of epistemology.

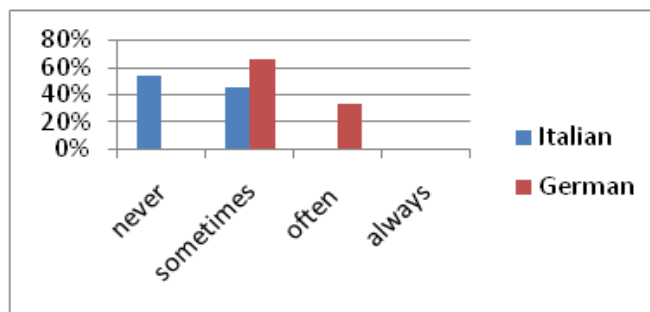
The results of the questionnaire were confirmed by the direct observation of the teachers at work in the class.

## Conclusion and Implication

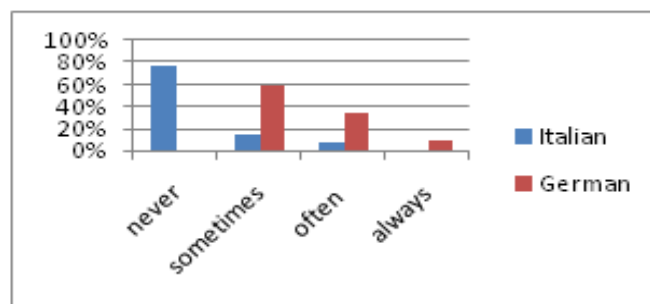
The results reveal differences in the implementation of CCBC. Especially the competence area of epistemology is underestimated in Italy. Furthermore, the Italian teachers' approach is more traditional and transmissive. This supports the idea that a clear and systematic description of the competences, their constituents and the learning outcomes, like the one present in Germany, can help the teachers to foster the implementation of CCBC. Due to this a proposal had been developed and presented to a group of experienced Italian chemistry teachers, and the results had been discussed in a workshop. The feedback was positive; the Italian teachers appreciated the schematic approach, and especially the operative description of the learning outcomes, which is helpful to design curricula and to select teaching activities.



**Figure 1:** Percentage of answers given by the Italian and German teachers to the question: Do you make students carry out experiments?



**Figure 2:** Percentage of answers given by the Italian and German teachers to the question: Do you make students design experiments?



**Figure 3:** Percentage of answers given by the Italian and German teachers to the question: Do you make students carry out experiments designed by them?

## References

- [1] OECD-PISA Main Results (URL: [http://www.oecd.org/pages/0,3417,en\\_32252351\\_32236130\\_1\\_1\\_1\\_1\\_1,00.html](http://www.oecd.org/pages/0,3417,en_32252351_32236130_1_1_1_1_1,00.html), online 10.09.2012).
- [2] MPI (2007). *Il nuovo obbligo di istruzione: cosa cambia nella scuola?* Firenze, Italia: ANSAS Grafiche Gelli – (URL: [http://www.invalsi.it/invalsi/rn/odis/doc/Obbligo\\_I\\_Parte.pdf](http://www.invalsi.it/invalsi/rn/odis/doc/Obbligo_I_Parte.pdf), online 10.09.2012).
- [3] MPI (2010). *Linee guida per il passaggio a nuovo ordinamento*. Istituti Tecnici. In D.P.R. 15 marzo 2010, articolo 8, comma 3 (p. 55-56; 84-85). (URL: [http://www.indire.it/lucabas/lkmw\\_file/nuovi\\_tecnici///LINEE\\_GUIDA\\_TEC\\_.pdf](http://www.indire.it/lucabas/lkmw_file/nuovi_tecnici///LINEE_GUIDA_TEC_.pdf), online 10.09.2012).
- [4] KMK (2004). *Bildungsstandards im Fach Chemie für den Mittleren Schulabschluss. Beschluss vom 16.12.2004*. München: Luchterhand.
- [5] KMK (2010). *Naturwissenschaften, Biologie, Chemie, Physik. Entwurf Verbändebeteiligung: 16.12.2010*. (URL: [http://www.standardsicherung.schulministerium.nrw.de/lehrplaene/upload/klp\\_SI/nw/GE\\_NW\\_Bio\\_Che\\_Phy\\_2010-12-16\\_Verbändebeteiligung.pdf](http://www.standardsicherung.schulministerium.nrw.de/lehrplaene/upload/klp_SI/nw/GE_NW_Bio_Che_Phy_2010-12-16_Verbändebeteiligung.pdf), online 10.09.2012).
- [6] Weinert, E. F. (2001). Vergleichende Leistungsmessung in Schulen – eine umstrittene Selbstverständlichkeit. In F. E. Weinert, *Leistungsmessungen in Schulen* (p. 17-31). Weinheim und Basel: Beltz Verlag
- [7] EU (2006). *Recommendation of the European Parliament and of the Council on the establishment of the European Qualifications Framework for lifelong learning*. (URL: [http://ec.europa.eu/education/policies/educ/eqf/com\\_2006\\_0479\\_en.pdf](http://ec.europa.eu/education/policies/educ/eqf/com_2006_0479_en.pdf), online 10.09.2012).



## **Study of the Relationship of Student-Teacher Dialogical Interactions in a Brazilian School from the Perspective of Toulmin's Argumentation Framework, Cyclic Argumentation, and Indicators of Scientific Literacy**

**Susan B. C. ARAGÃO, Maria Eunice R. MARCONDES, Miriam P. CARMO, Rita C. SUART**

*University of São Paulo, Av. Professor L. Prestes, 748 - São Paulo-SP-Brazil,  
05508-900 susan.aragao@usp.br*

### **Abstract**

*This research has the main objective to present the results of how the student-teacher dialogical interactions [1] contributed to the development of the arguments of 25 students from the 10<sup>th</sup> grade of a Brazilian school, in a investigative laboratory work to solve a problem related to the following question: "Where does the energy come from in chemical changes?" This study shows the results of the first six meetings, whose arguments were divided into 10 episodes. The classes were video-audio recorded and the arguments identified in the transcriptions were analyzed according to Toulmin's Argumentation Pattern [2]. The levels of students' argumentative reasoning related to the teacher dialogical interactions were also analyzed, as well as the presence of the Indicators of Scientific Literacy (ISL) [3]. The results indicated that the type of question asked by the teacher affects directly the students' answers and the intensification of the presence of the Indicators of Scientific Literacy, evidencing a cyclic argumentation to solve the main question of the problem, which was resumed by the teacher several times, always in a deeper way.*

**Keywords:** Toulmin's Argumentation Framework, Dialogical Interaction, Literacy

### **Introduction**

Argumentation has been widely used in science teaching as a way of presenting a scientific explanation of a particular concept, whose arguments and evidences presented are focused on the teacher. However, it may restrict the development of the students' skills, such as, arguing, critical thinking, reflecting and making judgments of values in the pursuit of problem solving.

Researches have shown that cognitive skills and reasoning can be better developed in environments in which students participate actively in the construction of concepts, expressing their ideas, and participating in discussions during science classes [3-4-5-6]. This research identified and analyzed ten arguments transcribed during investigative and experimental science classes about the energy involved in chemical changes. This analysis was based on Toulmin's Argumentation Pattern (TAP)[2]. Students should reflect on the following problem question: "Where does the energy come from in chemical changes?". The objective was to investigate the levels of student's argumentative reasoning related to the student-teacher dialogical interactions (STDI) as well as the occurrence of indicators of scientific literacy (ISL).

### **Theoretical background**

Toulmin's Argument Pattern (TAP)[2] is used by some authors as the basis for their investigation in the discourse analysis in science classes [3-4-5-6]. This pattern is composed by the following elements: data (D), warrant (W), conclusion (C), qualifier (Q), and rebuttal (R). Although Toulmin's framework does not have the specific goal of the field of education, it has been used in research about science education [5]. However, it has some limitations, such as: the arguments are not contextualized, the warrants are not explicit, it requires a long discourse to identify the elements of his pattern, and sometimes there are ambiguities of the elements when used to categorize the argumentative discourse [4-5-6].

Sasseron describes a methodology using the Toulmin's Argumentation Pattern [3]. This author formulated the idea of cycle in argumentative discourse in science classes, setting the argument as *"the ability to*

*relate data and conclusions, evaluate theoretical statements in the light of empirical data or from other sources.*" [3]. Therefore, through epistemological operations, such as induction, deduction, causality, the discourse of science classes is drawn, thus making the argument more complex.

In an argument cycle, it can be observed some Indicators of Scientific Literacy (ISL). These indicators are skills or actions that students and teachers use during the argument, such as, raising hypotheses, classification, organizing the information, construction of an explanation, justification to support the ideas, logical and proportional reasoning.

The identification of these indicators in the discourse of science classes allows an investigation of scientific literacy process of students. However, there is no hierarchy among indicators, so, they may arise during the speech in random order and there are no degrees of importance or chronological order, they are all equally important in the learning process [3].

Another important aspect related to investigative experimental activities that may contribute to the development of cognitive skills is that the student role is not passive during the learning process, because there are not only procedures and observation. Students have the opportunity to participate, for example, proposing hypotheses to explain the problem, collecting data, analyzing, and developing conclusions based on their ideas, participating in the construction of a concept or scientific knowledge. The investigative activities at the same time arouse curiosity and guide the students on the relevant variables of the phenomenon studied, and provide them the chance to raise their own hypotheses and propose possible solutions [1-7].

## Methodology

The aim of the researchers was to investigate the ideas of 25 students, 14-15 years, of the 10<sup>th</sup> grade in a Brazilian school about the heat released during chemical changes. The classes were audio-video recorded and the transcript was analyzed. This study presents the results of the first six meetings of fifty minutes each, whose arguments were divided into 10 episodes after transcription of audio-video recordings.

During the meeting, the teacher guided a discussion to investigate the students' ideas about chemical changes and heat. Through this discussion, the teacher came up with the following question for the students: "Where does the energy come from in chemical changes?" It was possible to infer that the students were able to establish relationships about chemical changes, energy and heat. After that, two experiments were carried out by students, for them to realize the elevation and lowering of the temperature involved in a chemical change. Experiment 1: (sodium hydroxide + water), experiment 2: (potassium nitrate + water).

Finally, students and teacher discussed about the experiment and drew conclusions about it.

## Data analysis and results

Ten arguments were observed based on Toulmin's Argumentation Pattern (TAP). For the analysis of the arguments we elaborated levels of Dialogical Interactions (DI), levels of Students' Argumentative Reasoning and identified Indicators of Scientific Literacy (ISL).

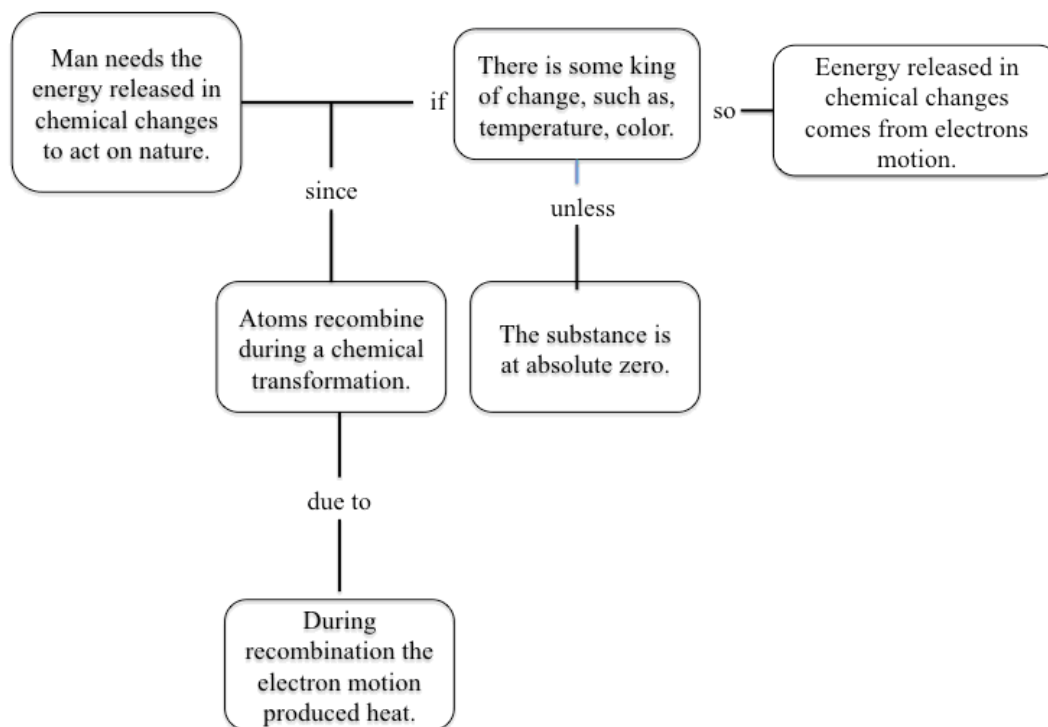
On episode 2, it was possible to find three of the six Toulmin's elements: data, warrant, and conclusion, and the student-teacher dialogical interactions analyzed were level 2, in which the teacher accepted what students spoke, discussed their answers, requested more examples. However, the teacher changed the subject without continuing the discussion. As it was observed, the teacher did not encourage students to link their own ideas, in order to permit further reflections. The level of students' argumentative reasoning was low, level 1: students interacted expressing views based on stored data and expressed demands to recall or remember. They did not establish conceptual connections neither raised hypothesis to solve the problem question, though. Only three indicators of scientific literacy were observed: organization of information, explanation, and logical reasoning.

On episodes 5, 6, and 7 rebuttals were identified, which indicated better quality of arguments emphasizing the dialogical interactions and the level of students' argumentative reasoning. This also indicates an increasing of epistemological operations performed by the students, which implies the presence of

indicators of scientific literacy, observed as predictions and justifications.

On episode 9, only four Toulmin's elements were identified: data, warrant, qualifier, and conclusion. The student-teacher dialogical interactions were the highest level, which is level 5, teacher accepted what students spoke, discussed their answers, encouraged them to think and used their own ideas for further reflection. Moreover, the level of students' argumentative reasoning was 4, because the students were able to establish conceptual connections, and raise hypothesis in order to solve the problem question. It was possible to identify five indicators of scientific literacy: organization of information, explanation, logical reasoning, justification, and raising hypothesis.

On episode 10, a final argument was built connecting all students' ideas, as shown in picture 1:



**Picture 1:** final argument

The level of students' argumentative reasoning was 4, because they could connect the concepts, and raise hypothesis in order to solve the problem question. Furthermore, five indicators of scientific literacy were identified: organization of information, explanation, logical reasoning, justification, and raising hypothesis.

According to the analysis of the arguments, as the student-teacher dialogical interaction advanced, the level of students' argumentative reasoning became more complex and also students were able to establish connections between concepts, raise hypotheses, make predictions in order to solve the problem question proposed by the teacher.

During the analysis of the arguments, we observed that when the teacher asked questions that only required the recall or exemplification of a fact or concept, the level of the student's argumentative reasoning in the construction of the concept was the lowest, and fewer Indicators of Scientific Literacy emerged. However, when the questions were more elaborated, better levels variables appeared. Besides, there is no relationship between the quantification of the presence of Toulmin's elements, the student-teacher dialogical interactions (STDI), the level of students' argumentative reasoning and the presence of indicators of scientific literacy (ISL). Although, on episodes 1 and 8 there were many of Toulmin's elements, the level of student-teacher dialogical interactions ranged from 1 to 5.

## Conclusion

This study showed that the activity developed presented characteristics of an investigative approach, since the students could participate in the process of developing hypotheses, analyzing data, drawing conclusions, discussing ideas for the construction of scientific knowledge at school [1-7]. Argument contributed to the conceptual development, since students have built their arguments to explain phenomena using their own ideas and appropriating more of a critical thinking to a better understanding of scientific ideas.

It was possible to infer that the teacher role is extremely important, because how he/she asks questions and guide discussions may affect the level of students' argumentative reasoning with implications for the level of learning of concepts. This implies the need for the teacher to prepare his/her teaching plan, reflecting on these needs, especially if the activity is interactive and with dialogue [6].

The answer to the problem question was built collectively, so that, the discussion allowed students to build together the concept to resolve the given problem: "Where does the energy come from in chemical changes?". This construction was given in a cyclic manner, *i.e.*, the problem was taken up the issue several times and always getting deeper by the teacher.

Generally, there were some indicators of scientific literacy throughout the discussion, such as, raising hypothesis and making a prediction. These indicators are meant to organize the reasoning and reformulate new conclusions, as data was introduced into the discussion, structuring an argumentative cycle [7]. Thus, the students could understand some concepts and terms involved in the scientific exploration of the theme energy and heat in chemical changes.

Although quantification of the presence of Toulmin's elements did not have a direct relationship with the level of student-teacher dialogical interaction, their presence, especially qualifiers and rebuttals, may assist the teachers to reflect and understand about their actions in an argumentative context.

## Reference

- [1] R. C. Stuart, M. E. R. Marcondes, *Ciências e Cognição*, 2009, 14, 50.
- [2] S. E. Toulmin, *The uses of argument*, Cambridge University Press, Cambridge, 1958.
- [3] L. H. Sasseron, A. M. P. Carvalho, *Ciência & Educação*, 2011, 17, 97.
- [4] R. Drive, P. Newton, J. Osborne, *Science Education*, 2000, 84, 287.
- [5] S. Erduran, S. Simon, J. Osborne, *Science Education*, 2004, 88, 915.
- [6] M. P. Jiménez-Alexandre, A. Bugallo Rodriguez, R. A. Duschil, *Science Education*, 2000, 84, 757.
- [7] A. M. P. Carvalho, E. I. Santos, M. C. P. S. Azevedo, M. P. S. Date, S. R. S. Fujii, V. B. Nascimento, *Termodinâmica: Um ensino por investigação*, Universidade de São Paulo, São Paulo, 1999.

## The role of science in a fragile world

Vincenzo BALZANI

*Department of Chemistry "G. Ciamician", University of Bologna, Bologna, Italy,  
E-mail: vincenzo.balzani@unibo.it*

### Abstract

*Science and technology permeate more and more the human society. Some scientists have pointed out that the development of science increases the fragility of our world. The most important, but not unique, reason is the strict connection between science and military establishment. Limiting and controlling scientific research is a difficult problem, but a democratic society must collectively take decisions on the development of science. Honest and clean science communication is extremely important to foster democratic decisions. Complexity is a common feature of all problems facing mankind and in such a complex world we need science to propose solutions and wisdom to choose among them. Progress of science and availability of a powerful energy source like fossil fuels have led to the present epoch, anthropocene, where human beings are no longer passive passengers of spaceship Earth. The shortage of fossil fuels, the extensive damages caused by their use, and a new consciousness of living in a resource-limited world require a transition from fossil fuels to renewable energies, from wastefulness to efficiency, and from consumerism to sustainability. Besides teaching good science, we should teach and discuss with our students other not less important topics, like to be aware of the limitations of science and technology, to remember that science has to be guided by ethical values, to pay attention to the needs of the society, to become authoritative and concerned citizens, and to like disconcerting truths better than reassuring lies.*

**Key Words:** anthropocene, energy, complexity, scientific research, teaching science.

### End of Science?

Science has developed so much in recent years that one may wonder whether it is close to its end. In the last page of the book "The Theory of Everything" [1] it is written that "... If we will be clever enough to discover such a unifying theory, we will decree the definitive triumph of human reason, since we will know God's thought". One of the strongest ambitions of some scientists is indeed that of becoming like God. It is much better to recognize that our knowledge is very limited, as pointed out, for example, by John Maddox, in his book entitled "What remains to be discovered" [2]. A few years ago *Science* tried to make a list of the 25 most important questions that are waiting for answers. After having realized that it was impossible to stop at 25, the list went on up to 125 questions before concluding that it was an impossible task since "The highway from ignorance to knowledge runs both ways: as knowledge accumulates, diminishing the ignorance of the past, new questions arise, expanding the area of ignorance to explore" [3]. The same concept had been expressed, more than two centuries earlier, by Joseph Priestley in a poetical way: "As the spotlight increases, the dark edge around it increases too. The more we make light, the more we have to be grateful because this means that we have a larger horizon to contemplate".

Other scientists believe that one day, perhaps in a few centuries, the scientific age, like the stone age and the iron age, will come to an end. Not, however, because we will know everything, but because science will reach the border of what it can explain [4]. From a philosophical viewpoint there are indeed four types of "things": (i) things we know we know: e.g., H<sub>2</sub>O; (ii) things we know we don't know: e.g., the chemical basis of conscience; (iii) things we don't know we don't know; (iv) things that we cannot know due to intrinsic limits of human mind: there may be some aspects of reality we cannot understand or some question we cannot pose [5].

### Science and scientists

Will it end or not, science has limits and boundaries. Science rationalizes the occurrence of natural phenomena, but it does not explain *why* they take place. For example, we know the law that governs the force of gravity, but we do not know why masses act on each other at a distance. Science has no answer for the so-called *questions of sense* like: which is the meaning of my life? Why there is a mystery of evil? Does God exist? Answers to these questions should be found in other fields of the human culture, such as philosophy and religion. Science permeates but does not fill up the space of mankind culture.

Science is important and useful not only because it brings us material benefits, but also because it trains people to democracy teaching the correct method that should be used in dealing with any kind of problem: listening, collaborating, acting with rigor and objectivity, avoiding dogmatism, keeping doubt alive, exchanging ideas. Exchange of ideas is, indeed, the basis of any kind of human progress. A famous aphorism of George Bernard Shaw says: "If you have an apple and I have an apple and we exchange these apples, then you and I will still each have one apple. But if you have an idea and I have an idea and we exchange these ideas, then each of us will have two ideas". This aphorism has been recently updated by Dan Zadra using dollars instead of apples.

We often tell our student that science is important and useful, but generally we do not care to explain them that science is beautiful. Sometimes the job of a scientist is compared to that of an artist, but there is a fundamental difference that can be illustrated with a simple example. Looking at a superb tree, a poet can take inspiration to write a beautiful poem, and a painter to create a marvelous picture. A scientist too is admired looking at a beautiful tree, but his mind does not stop at beauty, it goes on to consider that there would be no tree without the Sun. Better, to use the words of Richard Feynman [6], "A tree is essentially made of air and sun. When it is burned, it goes back to air, and in the flaming heat is released the flaming heat of the sun which was bound to convert the air into tree". The two most important natural phenomena, photosynthesis and combustion, that we often explain with many boring words, look so interesting after reading these few Feynman's lines! A scientist understands, and is deeply amazed, that a tree is essentially made of air and sun and wants to know more. He images a much simpler scene and asks himself some questions: why light is needed to grow a tree? How does a tree use light energy? What is light? Scientists are curious people, science is indeed based on curiosity. In an attempt to satisfy his curiosity, a scientist tries to interrogate Nature. His questions are presented in the form of experiments, which must be carefully planned and executed. The more intelligent is the question, the more important will be the answer. Perhaps, the greatest surprises in the field of science will be answers to questions that we are not yet ready to formulate. Then the scientist analyzes the results of the experiment, that is Nature's answers. He has to look at these answers with great attention and passion because, as Albert Szent-Gyorgyi said, "Discoveries consist in seeing what everybody has seen and thinking what nobody has thought" [7]. The results obtained with the experiments lead to knowledge, and knowledge leads to astonishment, exciting new curiosity that leads to the formulation of new questions and the design of new experiments. One might think that this merry-go-round of questions and answers will end after a few cycles, but this is not true, because discoveries add new questions to the list of those that remain to be solved. This is the reason why a scientist can never say to be satisfied. As it happens in a Tale of Chassidims written by Martin Buber, to the question "You got knowledge, what do you need?", the answer of a wise scientist is: "Indeed, only if you get knowledge you know what do you need" [8].

### Science and war

Nowadays, society depends more and more on science and science and technology develop at a growing rate. Should we fear this development? A first reason of fear is the tight connection between science, technology, and war. According to a recent report by the Stockholm International Peace Research Institute (SIPRI) eight states possess about 4400 operational nuclear weapons, nearly 2000 of these are kept in a state of high operational alert [9]. Furthermore, the present political conditions do not allow taking operative decisions on biological weapon control, and Russia and the USA have declared that they were unable to complete the destruction of their chemical weapon stockpiles by the final mandated deadline of

29 April 2012. For 2011, the military expenditure is estimated to have been \$1738 billion, representing 2.5 per cent of global gross domestic product or \$249 for each person. Joseph Stiglitz estimated that, apart from its tragic human toll, the true final cost of the Iraq conflict will be three trillion dollars [10].

As soon as something new is discovered or invented by science, the military establishment tries to catch it. For example, when nanotechnology began to develop, the US Army and the famous MIT joined together to make the Institute of Soldier Nanotechnology. The military establishment is looking carefully to any technological development, as shown by what happened to me some years ago. We were working on artificial photosynthesis and we published a couple of papers on decanuclear ruthenium dendrimers, which we used as antennas for light harvesting [11]. One day I got a letter from the US Army inviting me to attend a meeting on military applications of dendrimers. I did not go, but it was appealing because attending the meeting would have resulted in getting money for our research.

### **The development of science makes our world more fragile**

As science develops, we can say with Newton that we can see further, but nowadays seeing further can generate fear. Scientists have pointed out that the development of science increases the fragility of our world. In his book "Our last hour" Martin Rees writes that there is no more than 50% probability that our civilization will survive until the end of this century because of bad or incautious use of the most recent developments of science and technology [12]. Other scientists have warned about further development of science: there is not much time to decide what we should do and what we should not do [13]. It has also been noticed that the new technologies have the ability to change the very essence of our beings and that we are overcoming the boundary between enough and too much [14]. Several scientists have emphasized that our finite planet cannot sustain an endless expansion [15] and that we should take ecological constraints as a given, not a hindrance but a source of long-term economic security [16]. According to Stephen J. Gould [17], the fragility of the world can be summarized in the great asymmetry principle: "The essential human tragedy lies in a great asymmetry in our universe of natural laws. We can only reach our pinnacles by laborious steps, but destruction can occur in a minute fraction of the building time. A day of fire destroyed a millennium of knowledge in the library of Alexandria and centuries of building in the city of London". Such an asymmetry between our capacity to build up and destroy becomes, of course, greater and greater as science and technology develop. Nowadays, a nuclear war could destroy almost completely our planet in a few hours. An Italian philosopher, Umberto Galimberti, has summarized his pessimistic feeling about the development of science and technology in two sentences: "Man is powerless against science, because science is stronger than man. The question is no longer what can we do with science and technology, but what science and technology can do of us [18].

Recently, creation of a highly contagious form of the bird flu virus by Dutch and American scientists has raised a debate about whether the work should be published in full to aid pandemic preparedness or redacted to prevent misuse by terrorists [19]. According to some scientists, that work should never have been done, whereas others say that there should be a system of prior review and approval for potentially dangerous experiments. Concern is also generated by genetically modified microbes with tailored functions and presently in the US there is a debate about the approval of a genetically engineered salmon that grows to the market size in 16 months instead of 30. It would be the first genetically-engineered animal in the human food supply. Another controversial issue is that related to the production and use any kind of pills. There are trust pills because it has been discovered that some compounds (e.g., oxytocin) have effects on trust. A trust nasal spray is also available on internet. The use of these substances can give unfair social advantages [20]. Studies are in progress on compounds capable of modifying moral behavior. Who should decide about their use?.

### **Limits to scientific research?**

Since the progress of science makes our world more fragile, should we stop or limit scientific research? This is a very difficult question indeed. The aim of Science is to increase knowledge, to discover *the truth*. Therefore it seems unreasonable, in principle, to limit scientific research. It is true that discoveries

can have a dual use, but at the beginning of a research this point is often unclear and, in any case, *the truth will out*: it will simply be discovered later, perhaps by a less scrupulous scientist. Therefore, most scientists maintain that science should be free to expand. But there are problems that cannot be overlooked. To know a scientist must act. Knowledge is indeed entangled with action: knowledge presupposes action and action presupposes knowledge. A scientist, like any other person, acts on the basis of his ends and values that, by definition, are not neutral. If a scientist has no personal ends and values, he will play into ruling class' hands, as it happened in Germany during Nazism. Science is not neutral, it has a profound social dimension; furthermore, since knowledge can hardly be separated from its use, another difficult question arises: who is responsible for the applications of scientific work?

Several years ago, at an important meeting, Robert Oppenheimer said: "If you are a scientist, you believe that it is good to find how the world works ... and, as a citizen, you know it is good to turn over to mankind the power to control the world and to deal with it according to its values" [21]. Perhaps this is the best way: to employ a collective responsibility, just as for other important issues like education and health care. Therefore, a democratic society must discuss the role of science and must collectively take decisions on the development of science. Collective responsibility, of course, relies on science communication. Honest and clean science communication is extremely important to fill the fracture between science and society and to foster democratic decisions. This is the reason why in the University of Bologna we have activated a course of lectures on *Scienza e Società*, opened not only to students, but also to citizens. Such a course aims to construct a cultural bridge between the university and the town. There is a need to discuss the relationship between science and society with students and a need to explain science to laymen. Even more important would be to educate politicians on the most important scientific issues. Books like *Physics for Future Presidents* [22] can play an important role in this regard and an analogous book on Chemistry would be necessary since going towards a sustainable world needs a stronger advisory role of chemists.

### **Complexity, science and wisdom**

Several years ago Hannah Arendt observed that "Reality has the disconcerting habit of confronting us with the unexpected, for which we were not prepared" [23]. This is even more true today because the world is a system whose complexity increases further year after year. A simple example of increasing complexity related to chemistry is the following: two decades ago, a typical household owned products that altogether depended on less than 20 elements of the Periodic Table, whereas today a typical smart phone contains up to 60 different elements [24]. Complexity is a common feature of all the problems we have to solve: we need science to propose solutions but we also need wisdom to choose among them. Unfortunately at the universities all over the world we teach a lot of science, but not much wisdom, even here in Rome where Wisdom is the name of the University. Teaching wisdom should be the mission of the University and the background of science education.

### **Spaceship Earth and the energy problem**

People believe that the four most important problems of mankind are food, water, wealth and environment. In reality, behind these problems there is an even more important issue: energy, because food, water, health and environment depend on energy. In fact, everything around us and whatever we do depends on energy.

A famous Italian writer, Italo Calvino, was used to say that if you really wish to understand an important problem, you should first look at it from far away. Let's follow Calvino's suggestion, looking at the energy problem from very far away, from Saturn's rings, about 1.5 billion km from Earth. Seen from there, Earth looks like a dot. Before trying to solve the energy problem, we should acknowledge that the Earth is a spaceship [25] travelling in the infinity of the Universe: a very special spaceship that cannot land or dock anywhere for being repaired, a complex spaceship with seven billion passengers. They have to live altogether: white, black, and yellow people, poor and rich, no one can go away. After being aware of that, we can begin examining the energy problem with a quick look at the history of energy



consumption. Several thousands years ago, at the beginning of the human civilization, the few people living on the Earth got energy from man and animal power, wood and wind. Nothing changed for millennia, but about 200-300 years ago mankind discovered fossil fuels, an abundant, very powerful, and easy to use source of energy. The industrial revolution exploded and in a couple of centuries we have changed the world. We have mined coal and minerals, extracted oil and gas, constructed industries, built up and destroyed cities and roads, manufactured cars and machines, caused air pollution, accumulated enormous amounts of waste, and lighted the planet at night [15].

### **Anthropocene**

By using fossil fuels mankind entered a new era that scientists call anthropocene [26], characterized by a profound impact of man on the Earth. It is indeed a new phase in the history of both humankind and of the Earth. For centuries, natural forces have been stronger than human forces, so that humans were essentially passive passengers of spaceship Earth. The powerful energy of fossil fuels and the progress of science have reversed the situation: now human forces are stronger than natural forces and human beings are no longer passive passengers of spaceship Earth. They have power over Nature and have changed the rules by which the Earth systems operate. This is the reason why the world is fragile

### **Reinventing fire: from fossil fuels to renewable energies**

Using fossil fuels was and still is easy and very convenient, but, as everybody knows, now there are problems. First of all, fossil fuels are going to be exhausted. Second, the use of fossil fuels causes severe damages to human health and environment. Therefore there is a need to save energy and to develop alternative energy sources. The requirements needed for an ideal energy source capable of taking care of spaceship Earth would be the following: abundant, inexhaustible, well distributed on the entire planet, not dangerous today as well as in the future, capable of supporting economic development, reducing disparities, and fostering peace. The solutions presently proposed by scientists are essentially three: (i) going on with fossil fuels by extracting unconventional oil and gas, (ii) expanding nuclear energy, and (iii) developing renewable energies. To make the right choice, we need wisdom.

Unconventional oil and unconventional gas are relatively abundant and economically convenient in some nations like USA and Canada, but their exploitation will cause much greater damages to our spaceship than those already caused by conventional fossil fuels. These extreme attempts to obtain fossil fuels raise novel environmental concern, including the large volumes of water employed, water pollution and geological consequences of hydraulic fracturing [15]. In any case, unconventional fossil fuels cannot solve the energy problem for more than a few decades.

Nuclear energy is a dream that failed, although many people are not yet convinced. It failed because it is too expensive, but it should be discarded for several other, more important, reasons: safety problems, production of radiative waste dangerous for thousands of years, difficulties related to decommissioning and dismantling of the plants, proliferation of nuclear weapons, international political problems, increased disparities among nations [15].

The best solution for solving the energy crisis is to develop renewable energies, particularly solar energy since (i) the Earth receives from the Sun in one hour the amount of energy consumed by mankind in one year, (ii) the Sun will continue to shine for 4,5 billion years, and solar energy is fairly well distributed on the Earth. Solar energy indeed possesses all the requirements needed to take care of our planet and to supply energy for the future generations [15].

The transition from fossil fuels to renewable energies is something like reinventing fire [27]. It is expected to create a stronger economy and a healthier environment, but it will be not easy, because to exploit solar energy we need to convert sunlight into useful energies, namely heat, electricity and fuels. This holds true also for the exploitation of the other types of renewable energy.

### **Back to the Periodic Table**

To convert renewable energies into the energy forms we need, we must use equipment, machines and

devices: e.g., photovoltaic cells, wind turbines, pumps, batteries, etc. To make such devices we must start from metals and other available materials, which means that we must go back to what we have on our spaceship Earth: the chemical elements of the Periodic Table. We know that some elements are abundant, but others are relatively scarce. The most advanced technologies, including those used for energy conversion and storage, make extensive use of several elements that are or will become scarce. For example, lithium used for light batteries, transition metal elements like platinum, iridium, rhodium and cobalt used for fuel cells and catalysts, indium and tellurium used for photovoltaic devices, and rare earth elements like neodymium used for making permanent magnets, lanthanum for rechargeable batteries, cerium for TV screens and europium for lasers. The scarcity of several elements gives important research opportunities to chemists: on one side there is much to do concerning supply of such elements, which means to develop new technologies for extraction, conversion, processing, and recycling. On the other side, a new field is opened, that of substitutional research.

### **Resource efficiency**

Concern about scarcity of some materials used for energy conversion and advanced technologies are based not only on scarcity, but also on geographic, economical and political factors. For example, essentially all mining of rare-earth minerals occurs in China [28]. Therefore it could happen that we will have plenty of renewable energies, but limited availability of materials to convert them into useful energy. This is the reason why we need a completely different approach concerning not only energy, but any kind of resource of our planet: food, minerals, land, etc. [29] A new consciousness of living in a resource-limited world requires a transition not only from fossil fuels to renewable energies, but also from wastefulness to efficiency and from consumerism to sustainability. We need to create a more sustainable world by decoupling economic growth from resource consumption. The first rule for succeeding in a resource-limited world concerns waste: reduce waste, reuse and repair things as much as possible, and recycle any kind of material. Maintenance, repairs and overhaul offer enormous opportunities when combined with technological advancements such as 3D-printing, wireless networking, interchangeability through standardization, making parts in such a way that they already address the assembly and disassembly processes.

### **Education: disconcerting truths and reassuring lies**

In closing, what should we teach our students? Of course, to solve problems, to be careful in planning experiments, to be open to sharing ideas and collaborate, to publish results that can be replicated, to write papers and proposals easy to read, to follow safety regulations, to be able to communicate. But we should also teach our students, or at least discuss with them, others not less important topics, like to be aware of the limitations of science and technology, to remember that science has to be guided by ethical values, to pay attention to the needs of the society, to become authoritative and concerned citizens.

After all that, we should not forget to remember that there are three disconcerting truths: (i) we live in a crowded spaceship that cannot land anywhere, and there are no places to which our species can migrate; (ii) the resources available on the surface or stored in the holds of our spaceship are limited; we must use them with much care and creativity, and recycle them as much as possible (iii) the resources should be more fairly distributed among all the spaceship passengers if we wish to live in peace.

Discussing with students these disconcerting truths is particularly important in a world where most people prefer to listen reassuring lies such as: there is no reason to stop using fossil fuels, there is no need of saving energy, technology will solve all problems, “trickle-down” policies will make poor people happy, and war will eliminate terrorism.

We live in a spaceship that has been damaged and needs to be repaired by motivated young people. Their work can take inspiration from two sentences of two very different personalities of our civilization: Concern for man himself and his fate must always constitute the chief objective of all scientific endeavors. Never forget this in the midst of your diagrams and equations” (Albert Einstein), and “If I have the gift of prophecy, and can understand all secrets and every form of knowledge, and if I have

absolute faith so as to move mountains but have no love, I am nothing” (Saint Paul).

### Reference list

- [1] S. Hawking, *The Theory of Everything*, New Millennium Press, London, 2002
- [2] J. Maddox, *What Remains to be Discovered*, Macmillan Publishers Ltd, London, 1998
- [3] T. Siegfried, *Science*, 2005, 309, 76
- [4] R. Stannard, *The End of Discovery*, Oxford University Press, Oxford, 2010
- [5] M. Shermer, *Nature*, 2012, 484, 446
- [6] R.P. Feynman, *The Physics Teacher*, 1969, 7, 313
- [7] A. Szent-Gyorgyi, as cited in *The Scientist Speculates*, I. J. Good (ed.), Heineman, London, 1962
- [8] M. Buber, *Storie e leggende chassidiche*, Mondadori, 2008
- [9] SIPRI Yearbook 2012, Oxford University Press, Oxford, 2012
- [10] J.E. Stiglitz, L.J. Bilmes, *The Three Trillion Dollar War*, Norton, New York, 2008
- [11] V. Balzani, S. Campagna, G. Denti, A. Juris, S. Serroni, M. Venturi, *Acc. Chem. Res.*, 1998, 31, 26
- [12] M.J. Rees, *Our Final Hour*, Basic Books, New York, 2003
- [13] S. Greenfield, *Tomorrow's People*, Pinguin Books, 2003
- [14] B. McKibben, *Enough*, Henry Holt, New York, 2003
- [15] N. Armaroli, V. Balzani, *Energy for a Sustainable World*, Wiley-VCH, 2011
- [16] T. Prince, *The Logic of Sufficiency*, MIT Press, Cambridge (MA), 2005
- [17] S.J. Gould, *Science*, 1998, 279, 812
- [18] U. Galimberti, *I miti del nostro tempo*, Feltrinelli, Milano, 2009
- [19] Editorial, *Nature*, 2012, 485, 5
- [20] *Chemistry World*, 2012, 9 (5), 80
- [21] A. Smith, C. Weiner, *Robert Oppenheimer: letters and recollections*, Stanford University Press, Stanford, 1995
- [22] R.A. Muller, *Physics for Future Presidents*, Norton, New York, 2010
- [23] H. Arendt, *Crises of the Republic*, Houghton Mifflin Harcourt, Boston, 1972
- [24] R.G. Eggert, *Nature Chemistry*, 2011, 3, 688
- [25] N. Armaroli, V. Balzani, *Energia per l'Astronave Terra*, Zanichelli, Bologna, 2011
- [26] P. Crutzen, *Nature*, 2002, 415, 23
- [27] A Lovins, *Reinventing Fire*, Chelsea Green Publishing Company, USA
- [28] E. Davis, *Chemistry World*, 2011, January, 50
- [29] J.B. Moody, B. Nogrady, *The Sixth Wave*, Random House, Sidney, 2010

## ICT in chemistry teaching on various levels of education

Malgorzata BARTOSZEWICZ

Adam Mickiewicz University in Poznan, Faculty of Chemistry, Grunwaldzka 6, 60-780 Poznań, Poland, e-mail: goskab@amu.edu.pl

### Abstract

*Common application of Information and Communication Technologies (ICT) in almost every life's domain shapes the contemporary society. It alters the manner in which people communicate, spend their spare time, acquire information and also learn. Modern educational system has to comply with occurring changes and new conditions. The usage of information and communication technologies in educational process enables to improve the efficiency of delivering didactic contents and to enhance lessons' and activities' attractiveness. The paper also presents exemplary possible methods of chemical contents' presentation in teaching nature sciences supported by information and communication technologies.*

**Keywords:** chemistry, nature, ICT, blended-learning

The computer and the Internet have become integral elements of the contemporary young people's natural habitat. They communicate with each other by means of social networks; they meet new friends, they learn new things and broaden their interests. Digital Natives is a generation which cannot imagine their life without the Internet [1]. Five years ago, Polish parents declared that 72% of children aged over three use the computer [2]. Furthermore, the average monthly amount of time students aged 7-14 spend in front of the computer screen amounts to 49.5 hours [3]. Research carried out on a group of high school students in their senior year pointed to the fact that 72% of them do not see any point participating in regular in-class lessons, and 79% of these students find their lessons not very interesting [4]. The situation is similar in Polish schools. Thus, a question arises how to make the school more interesting for the digital natives. What can we do to motivate them to make more effort to learn? How to bring the school closer to their interests and their life outside the school?

*One of the answers to the above questions could be platform-assisted learning. It can be used for:*

- teaching natural sciences (Biology, Physics and Chemistry) by asking questions and carrying out discussions with the teacher concerning the animations prepared and placed on the e-learning platform [5]. The lesson begins with an open-ended question asked by the teacher after watching videos. Students provide responses The teacher then provides follow-up comments or questions built on each other. Discussions result and students are able to consider the author's point as well as student's point. Teachers are able to model the QtA approach by discussing aloud their thoughts about the questions they ask while reading [6,7]. Project *e-Science Tutor* has been realised in primary and secondary schools for 2 years, since September 2011. In the project take part: 9 schools <sup>1</sup>.

---

<sup>1</sup>The ETOS project is run by Adam Mickiewicz University in Poznań in collaboration with Boulder Language Technologies, USA. Project managers and principal investigators are Prof. Katarzyna Dziubalska-Kolaczyk, Prof. Ronald Cole and Dawid Pietrala, M.A. The project is funded by the European Social Fund within the Human Capital Operational Programme (priority 3, call for proposals: 4/POKL/2009).



Figure 1. Tutorial

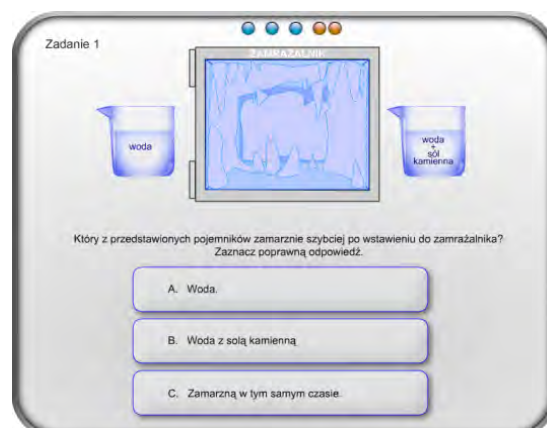


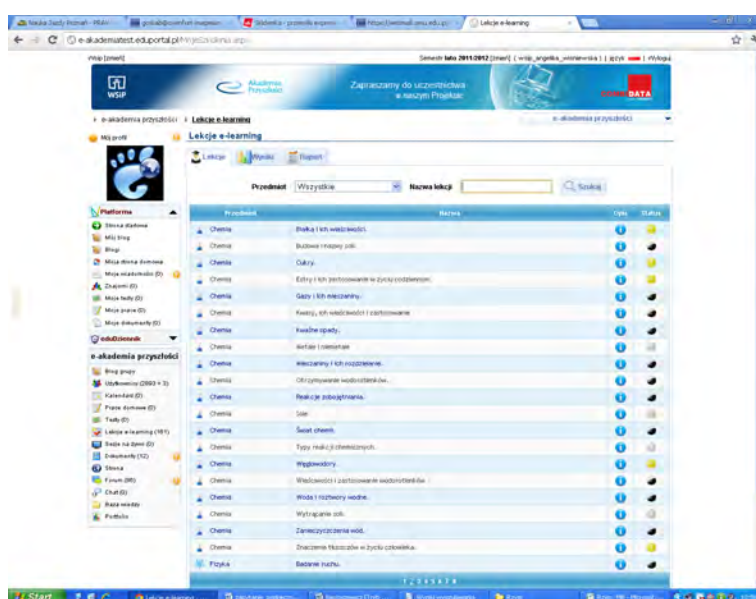
Figure 2. Test

- teaching Chemistry by developing key competences; e-learning units have been prepared as situations experienced by the avatars in the real life as well in laboratory situations [6].

Future's e-Academy authors' main assumption is shaping Key Competences on the basis of Middle School Forming Key Competences Programme, during lessons of science, English, IT or business. Key Competences were defined in recommendation of the European Parliament and the European Council on key competences for lifelong learning as:

- 1) Communication in the mother tongue;
- 2) Communication in foreign languages;
- 3) Mathematical competence and basic competences in science and technology;
- 4) Digital competence;
- 5) Learning to learn;
- 6) Social and civic competences;
- 7) Sense of initiative and entrepreneurship;

Creating Key Competences takes place during lessons, optional courses and pupil's individual activities.



## Organisation

Project has been realised in schools for 3 years, since September 2010. In the project e-Academy Future: 200 schools, 1600 teachers, 19000 pupils, take part.

Project is implemented during math, physics, biology, geography, English, IT and business lessons. Especially to enable carrying out the project an e-learning platform on which pupil's and teachers materials are uploaded, was launched.

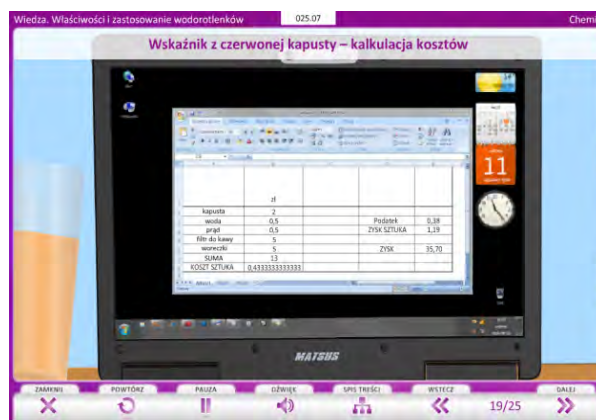
Substantial content – creating Key Competences in the framework of chemistry lessons

Creating Key Competences in the framework of chosen subject will take place will take place by using 168 e-learning units, including 21 regarding chemistry.



**Figure 3.** Communication in the mother tongue

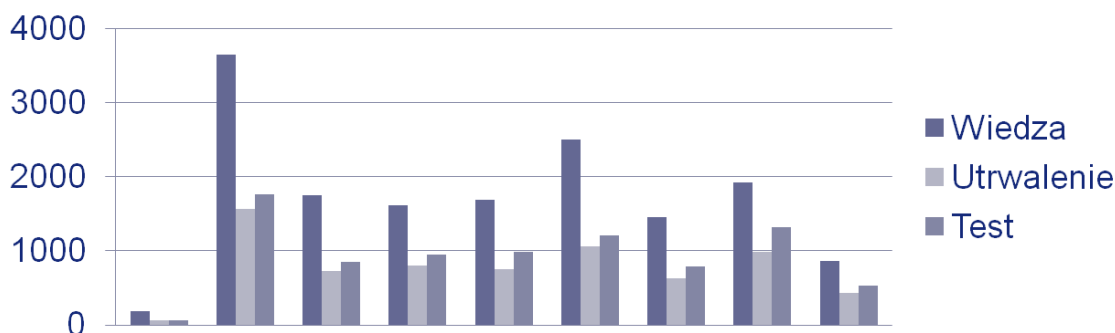
Avatar: Read the text carefully and then I am going to check your level of reading comprehension. Purpose: increasing the level of reading comprehension [8]



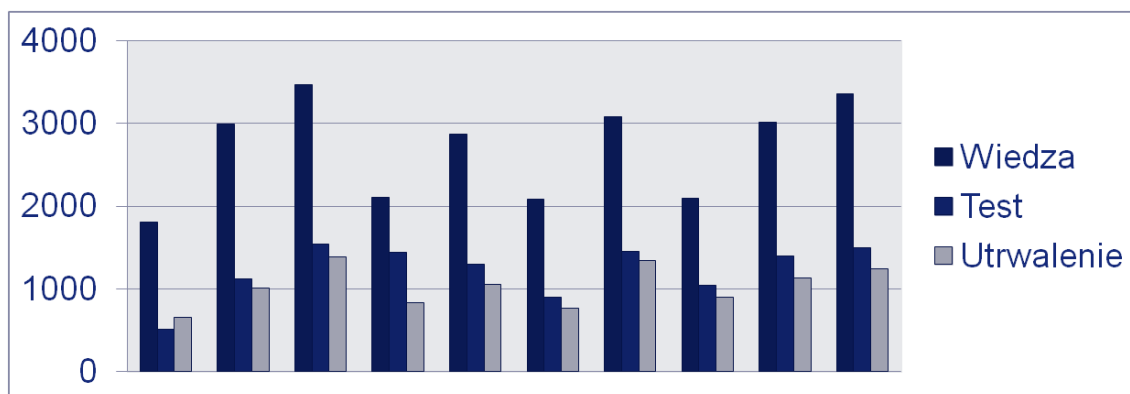
**Figure 4.** Sense of initiative and entrepreneurship

Indicator from red cabbage - calculation of costs. Purpose: To estimate the cost and sell the cabbage indicator paper on the online auction site [8]

Project's implementation in the school year 2010/2011 and 2011/2012. Every e-learning unit consists of three modules: knowledge (pol. *Wiedza*), revision (pol. *Utrwalenie*) and test (pol. *Test*). The chart presents the number of logins in particular months:



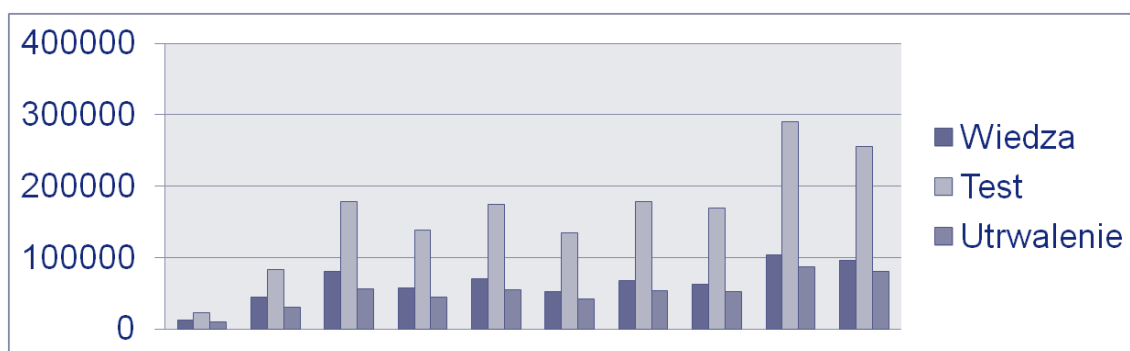
**Figure 5.** The number of logins – teachers  
IX-VI 2011/2012  
knowledge (pol. *Wiedza*), revision (pol. *Utrwalenie*), test (pol. *Test*)



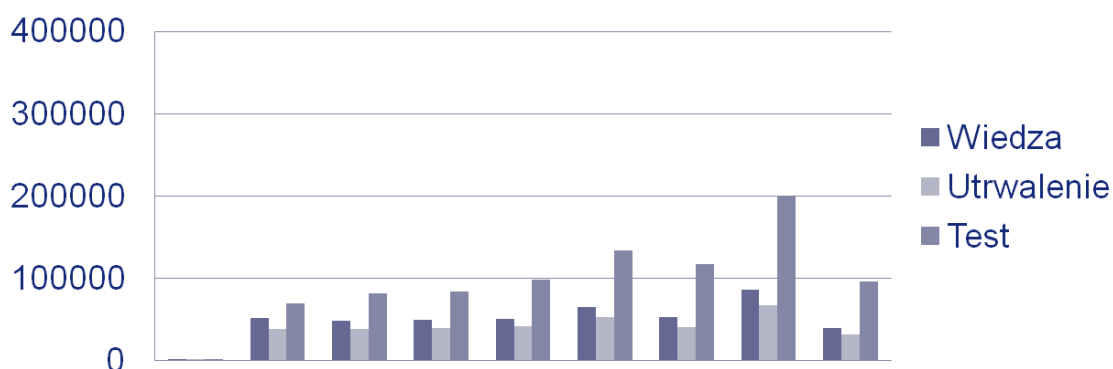
**Figure 6.** The number of logins – teachers  
IX-VI 2010/2011  
knowledge (pol. Wiedza), revision (pol. Utrwalenie) , test (pol. Test)

In 2011/2012 on average, teachers spend 8.4 hours on the platform of a month and students spend 8.2 hours on the platform of a month.

In 2010/2011 on average, teachers spend 2.0 hours on the platform of a month and students spend 2.4 hours on the platform of a month.



**Figure 7.** The number of logins – students  
IX-VI 2011/2012



**Figure 8.** The number of logins – students  
IX-VI 2010/2011

Working methods related to units regarding separate subjects: a supplement to the lesson;

- ❖ knowledge module is presented by teacher during a lesson while at home students prepare notes on the subject;
  - ❖ knowledge module is presented by teacher during a lesson, revision & test modules are used by student at home;
  - ❖ knowledge module is presented by teacher during a lesson, revision module is used by student at home, while the test is taken in a paper form in the class;
  - ❖ students prepare themselves for a lesson using knowledge module; during the lesson the issue is presented and then under teacher's supervision a test is taken;
  - ❖ whole units are used as homework;
  - ❖ units are applied during extra lessons in a computer class [9].
- teaching Chemistry is started even before the traditional lesson starts; by means of the Google apps platform, students prepare for classes according to the instructions received from the teacher, which allows them to discuss the topic at school in a problem and multi-contextual manner. The preparatory process is managed and inspected by the teacher via the platform. Students store the materials in their files and then create their individual digital portfolios [10]. The teacher does not present the material but elaborates on it, interprets, systematizes, explains doubts, and answers the questions that the students might have. After the lesson, students have to decide what else could have been added, what sources have been forgotten, how they could have improved the structure of their work or what has changed in their knowledge of the subject since they time they started working on it.

Project *Collegiums Śniadeckich* has been realised in high schools since September 2011. In the project take part: 2 schools.

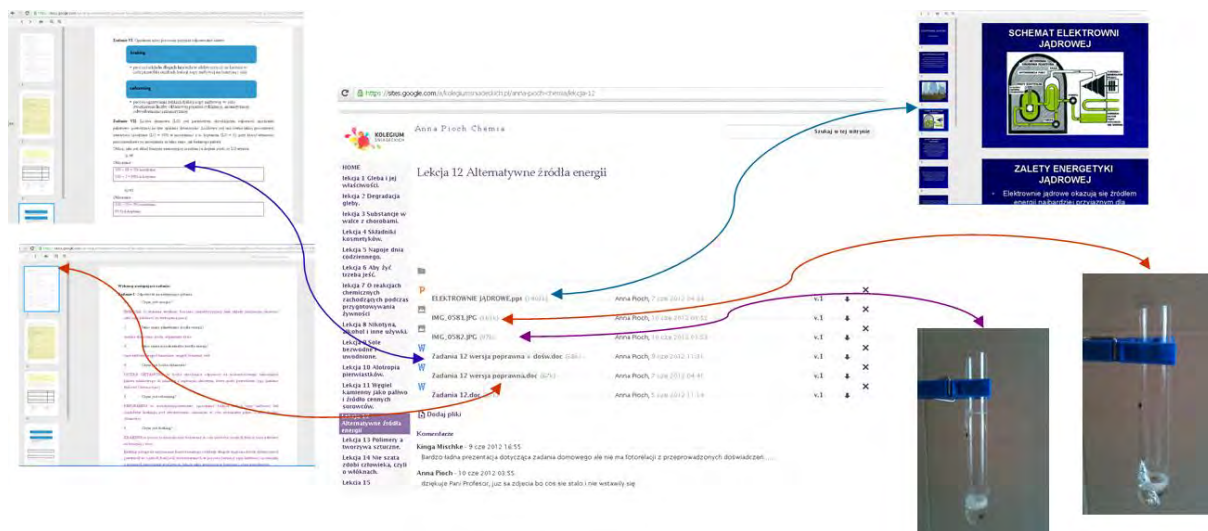


Figure 9. Digital portfolios

The educational platform-based learning may take place at various times and place which makes it possible for the users to continue their development outside the classroom and expand their interests beyond the material normally required at school.

The results, successes or failures of supporting teaching using information technology in above mentioned projects will be presented once they are completed, that is in two years



**Reference list**

1. Don Tapscott, *Grown up digital*, Mc Graw Hill, New York, 2009
2. Badanie w ramach kampanii „Cała Polska czyta dzieciom” 2007 Gemius, (Dzieci aktywne online, [http://emilek.pl/artykuly/raport\\_gemius\\_dzieci\\_aktywne\\_online.pdf](http://emilek.pl/artykuly/raport_gemius_dzieci_aktywne_online.pdf).)
3. Badanie Fundacji Dzieci Niczyje „Dzieci aktywne on-line” 2007
4. National Center for Education Statistics 2006, [nces.ed.gov/](http://nces.ed.gov/). [20.02.2012].
5. M., Bartoszewicz, T., Pietrala, *Scenariusze zajęć pozalekcyjnych z zakresu przyrody i chemii*, Poznań 2011 <http://ifa.amu.edu.pl/e-nauczyciel/>
6. I. Beck *Questioning the Author: an approach for enhancing student engagement with text*. Newark, DE: 1997 International Reading Association.
7. I. Beck, M. McKeown, C. Sandora, L. Kucan, & J. Worthy, (1996). *Questioning the Author: A Yearlong Classroom Implementation to Engage Students with Text*. *The Elementary School Journal*, 96(4), 385-414
8. H. Gulińska, M. Bartoszewicz *Scenariusze jednostek e-learningowych z chemii*, Warszawa 2011 Projekt e-Akademia Przyszłości [www.e-akademia.eduportal.pl](http://www.e-akademia.eduportal.pl)
9. E. Grela, E., M. Plebańska, *Wyniki pracy na platformie e-learningowej w roku szkolnym 2010-2012* Warszawa WSiP.
10. H. Gulińska, M. Bartoszewicz, G. Makles, K. Mischke, *Scenariusze zajęć wyprzedzających z chemii*, Poznań 2011 <http://kolegiumsniadeckich.pl/>

## ChemEd DL WikiHyperGlossary: Connecting Digital Documents to Online Resources, While Coupling Social to Canonical Definitions within a Glossary

**Robert E. BELFORD<sup>1</sup>, Michael A. BAUER<sup>2</sup>, Daniel BERLEANT<sup>3</sup>, Jon L. HOLMES<sup>4</sup>, John W. MOORE<sup>5</sup>**

*1. Department of Chemistry, University of Arkansas at Little Rock, 2801 S. University Ave, Little Rock, AR, USA.  
rebelford@ualr.edu, (501)569-8824 (office), (501)569-8838 (fax).*

*2. UALR/UAMS Joint Bioinformatics Program, University of Arkansas at Little Rock, 2801 S. University Ave, Little Rock, AR, USA.*

*3. Department of Information Sciences, University of Arkansas at Little Rock, 2801 S. University Ave, Little Rock, AR, USA.  
rebelford@ualr.edu,*

*4. Journal of Chemical Education, University of Wisconsin-Madison, 209 N. Brooks St., Madison, WI 53715, USA*

*5. University of Wisconsin-Madison, 1101 University Ave., Madison WI 53706-1396, USA*

### **Abstract:**

*We are reporting on a social-semantic information literacy tool that has the potential to enhance reading comprehension, the WikiHyperGlossary (WHG), which is being developed for ChemEd DL, the Chemical Education Digital Library. The WHG automates the markup of digital documents and web pages by linking words in those documents to the content of a glossary database. This paper will discuss a strategy for improving reading comprehension of online resources in one's distill knowledge space by providing appropriate background knowledge through the coupling of content-appropriate social (wiki-generated novice level) definitions to canonical (expert level) definitions. This program not only connects these definitions to digital documents, but it allows for the social generation of the definitions at various levels of expertise, thereby expanding the educational value of canonical glossaries.*

**Keywords:** glossaries, web 2.0, web 3.0, information literacy, online learning, digital libraries

### **1. Introduction**

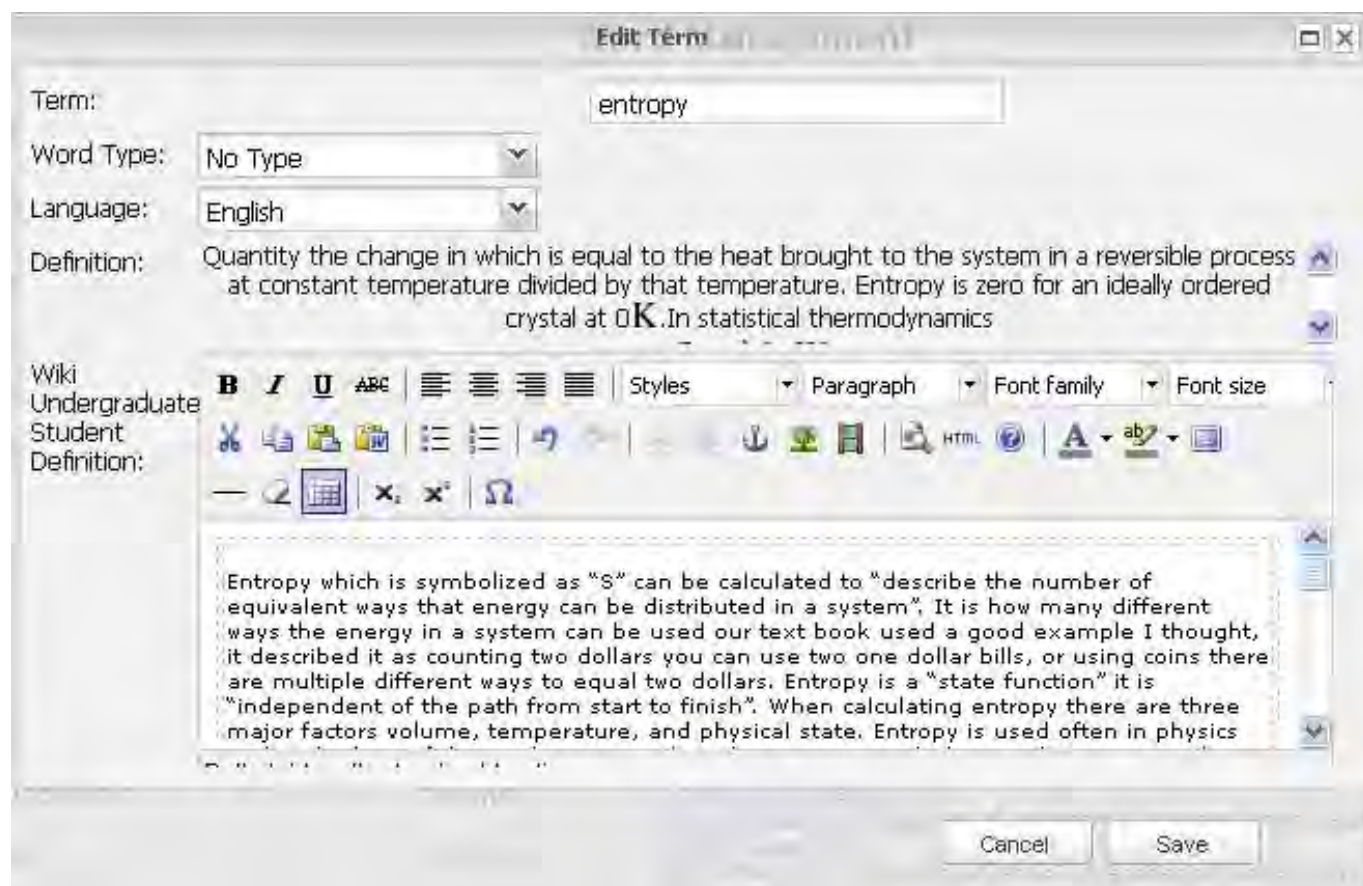
The rise of Information and Communication Technologies (ICTs) has generated an associated need for the development of digital information literacy tools. It is now commonplace for people to acquire articles that assume a higher level of reader expertise than they possess. Chemistry students, for example, would benefit greatly from the large amounts of technical material that could meet their knowledge needs if they had assistance in understanding those materials. Fortunately, the digital world provides the opportunity to develop software tools that can be deployed on the Web and meet these needs. Such tools are enabled by the computer and networking revolution where, previously, only expert tutoring could perform similar functions. The WikiHyperGlossary (WHG)[1] is an innovative example of such a software system. It is designed to assist novices in acquiring appropriate background knowledge as needed to comprehend material that otherwise would be above their level of expertise. One way this can be accomplished is by coupling socially generated, multimedia based novice-level definitions to expert-level canonical glossary definitions in a specific domain, and linking domain documents to this material through an automated markup process. Using the WikiHyperGlossary, this happens dynamically so that the software functions as a real-time assistant as the reader endeavors to understand valuable material. In the chemistry domain, IUPAC provides numerous reviewed canonical glossaries[2], and this article shows how the WikiHyperGlossary enables such expert-level glossaries to acquire new roles in online education.

### **2. What the WikiHyperglossary(WHG) Does**

The WHG has two interfaces, an open access public one and a restricted administrative interface, with the latter providing a variety of login dependent permissions. The public interface allows any person to

submit text documents and web pages to the WHG server, which returns the document in a web browser with any glossary terms within the document hyperlinked to the database content associated with that term. When such a link is activated, the associated material is then superimposed on top of the new webpage as a JavaScript overlay (Fig. 2). This overlay can present not only textual definitions with embedded multimedia objects, but through semantic technologies, chemical terms can also populate the overlay with a variety of software agents (molecular visualization and editing tools) and search services. These semantic features enable new options for document interactivity and knowledge discovery, as well as complement the strategy of using the socially generated multimedia definitions to enhance reading comprehension.

The WHG can generate a glossary through the administrative interface. When a person applies for an account they can be given a variety of permissions. The typical user would have the ability to create and edit terms, but not add people, set permissions or create glossaries. Each glossary term can have up to five definitions associated with it and figure 1 shows the TinyMCE[3] WYSIWYG editor based wiki interface that allows for the generation of social definitions (note that there are two definitions associated with this term, but only the bottom one editable). Someone with full administrative privileges can do all of the above, and in addition can set individual definitions as editable/non-editable, manage users, perform bulk glossary uploads, set citations for bulk uploaded glossaries, and perform a variety of database dump queries extracting definitions and histories.



**Figure 1.** Screenshot of “Edit Term” interface. Note, this term is in the IUPAC Gold Book glossary, and there are two text fields. The first, “Definition” is non-editable, while the second “Wiki Undergraduate Student Definition” is editable.

### 3. Enhancing Reading Comprehension

To meet the goal of enhancing reading comprehension, whether the learner is a novice or has some acquaintance with the field, the learner needs to choose a glossary of both the appropriate domain, and containing definitions developed at the learner's level of domain understanding. As noted by E. D. Hirsch [4], "Cognitive scientists agree that domain reading comprehension requires prior 'domain-specific' knowledge about the things a text refers to, and that understanding the text consists of integrating this prior knowledge with the words in order to create a situation model." Hirsch further points out [5], "Researchers have discovered that what the text implies but doesn't say is a necessary part of its understood meaning. In fact, what the text doesn't say often far exceeds what it says." Thus, merely providing definitions of terms in a document in one's distal knowledge space may be inadequate to enhance reading comprehension. Rather, what is needed is a set of definitions that provide an expansion of the learner's background knowledge in the subject domain that target the appropriate learner-dependent level of expertise. To summarize the point, the author of a document assumes prior knowledge that is not explicitly stated, but is implicit in the text, and the learner who is missing this implied information will have problems comprehending the document's content. Yet, by linking to the appropriate glossary and ancillary resources like multimedia repositories, this implicit knowledge can potentially be made accessible to the learner.

For the WHG to provide this implied knowledge, it needs to generate hyperlinks at both a high term density and at the appropriate content level. We fulfill this with a glossary architecture that couples novice level social to expert level canonical definitions. The domain-expert level canonical definitions (which can be bulk uploaded) provide the required domain dependent term density and an authoritative framework for developing the coupled social definitions, which in turn can be developed at the appropriate content level of expertise. In this architecture, the WHG can associate up to four different socially created definitions to each canonical definition. A related but distinct application of this capability is that the WHG can be used to create socially defined glossary entries in another language than the canonical definition. This could be of great value for education internationally, as student understanding of documents in a non-native language can often be an issue.

IUPAC definitions clearly fit into the category of canonical definitions and are not primarily designed for education, but rather to promote the practice of science through the standardization of scientific terminology. For example, the IUPAC Gold Book definition of entropy,  $S = k \ln W$  (Fig. 2) would not be of much value to someone unfamiliar with statistical thermodynamics, and by itself, would not help a large portion of the population who could be trying to comprehend a document involving thermodynamic concepts. By coupling it to the social generated definition with multimedia components like YouTube videos (figure 2) it gains new capabilities in providing background knowledge. The question then becomes, can the WHG introduce into a document sufficient glossary term density to generate the implicit background knowledge which was assumed when the article was authored?

## entropy

### Definition

Quantity the change in which is equal to the heat brought to the system in a reversible process at constant temperature divided by that temperature. Entropy is zero for an ideally ordered crystal at 0K. In statistical thermodynamics

$$S = k \ln W$$

where  $k$  is the Boltzmann constant and  $W$  the number of possible arrangements of the system.

Source:

[Green Book, 2nd ed., p. 48](#)

[PAC, 1990, 62, 2167](#) (*Glossary of atmospheric chemistry terms (Recommendations 1990)*) on page 2187

[PAC, 1996, 68, 957](#) (*Glossary of terms in quantities and units in Clinical Chemistry (IUPAC-IFCC Recommendations 1996)*) on page 972

Related index:

[IUPAC > Gold Book > math/physics > quantities](#)

### IUPAC GOLD BOOK

### Wiki Undergraduate Student Definition

Entropy which is symbolized as “S” can be calculated to “describe the number of equivalent ways that energy can be distributed in a system”. It is how many different ways the energy in a system can be used our text book used a good example I thought, it described it as counting two dollars you can use two one dollar bills, or using coins there are multiple different ways to equal two dollars. Entropy is a “state function” it is “independent of the path from start to finish”. When calculating entropy there are three major factors volume, temperature, and physical state. Entropy is used often in physics and in the laws of thermodynamics. When doing entropy calculations the units are J/K (joules/degrees Kelvin).

To find the change in entropy the equation is  $\Delta S = S_{\text{final}} - S_{\text{initial}}$  Entropy is found in our text book under chapter 18 section 3 it can be calculated and be used in many other calculations like the change in H, G, and T for reactions. Entropy is all around us from rusting of metals, fuel burning and ice melting. it is heat and energy being released. changed in entropy goes from Solid<liquid<gas and can be affected by temperature, volume, the number of molecules that are in reactants versus products.

<http://www.youtube.com/watch?v=D-y73FOA02Y>



**Figure 2.** Screen shot of JavaScript overlay that would be superimposed on an article. This is what the public would see, and the material below the yellow “IUPAC Gold Book” can be edited through the WYSIWYG editor in figure 1 and contain multimedia objects like YouTube videos.

## 4. Generating Social Definitions

Because socially generated glossary material is an integral part of the learning experience that the WHG provides to learners, it is necessary to support the creation of this material. The WHG administrative interface makes it easy for learners to collaboratively create such material, and thus provides a variety of unique opportunities for contemporary chemical educators and their students. A “Get History” administrative interface has been developed and so with the WHG, teachers and students can not only develop definitions with associated multimedia content coupled to official IUPAC definitions describing concepts like entropy at their level of expertise, but the teacher can print out the work based on a variety of queries. For example, you can print all work performed by a student over a specified timeline, with the last edit printed first, followed by the rest in chronological order. This enables the instructor to see the final product, followed by its editing evolution. Students at the University of Arkansas at Little Rock have been using the editor interface of the WHG to create definitions for four semesters with some intriguing results that we plan to report in the near future.

The development site of the WHG is <http://hyperglossary.org>, and we soon will have it installed on the Chemical Education Digital Library website[6]. There are currently versions working on both local and

cloud-based servers, and tutorials are being created for its use. We are interested in supporting multilingual glossaries and any faculty member interested in using the WHG with their students is encouraged to contact the lead author.

### 5. A Note on the History and Support for the WHG Project.

The WHG evolved out of the MSDS (Material Safety Data Sheet) Hyperglossary developed by R. Toreki of Interactive Learning Paradigms (ILPI) [7], which through the MSDS DeMystifier[8] connected MSDSs to static web page definitions designed to assist users in understanding MSDS. The MSDS DeMystifier went online in 2000 and in 2004 Toreki and Belford developed a collaborative project between ILPI and UALR, where students generated five-part definitions that were emailed to ILPI and manually added to the MSDS Hyperglossary.[9] In 2006 the idea of a WikiHyperGlossary was conceived[10] and in 2009 NSF (U.S. National Science Foundation) NSDL (National Science Digital Library[11]) grant 0840830 was awarded to develop a WHG for the Chemical Education Digital Library, and any opinions, findings, conclusions, or recommendations expressed in this material are those of the authors and do not necessarily reflect the views of the NSF. We gratefully acknowledge that support for the work reported here.

1. WikiHyperGlossary development site, <http://hyperglossary.org/> (last accessed September 2012).
2. IUPAC Published Recommendations, <http://www.iupac.org/home/publications/provisional-recommendations/published.html> (last accessed September 2012).
3. Tiny MCE-JavaScript WYSWYG editor, <http://www.tinymce.com/> , last accessed September 2012).
4. Hirsch, E.D., *The Knowledge Deficit*, Houghton Mifflin Harcourt, 2006, p.17.
5. *Ibid.*, p. 37.
6. Chemical Education Digital Library, <http://www.chemeddl.org/> (last accessed September 2012)
7. Interactive Learning Paradigms, <http://www.ilpi.com/index.html> (last accessed September 2012)
8. MS-Demystifier, <http://www.ilpi.com/msds/ref/demystify.html> (last accessed September 2012)
9. Toreki, R. & Belford, R., Improving Safety Comprehension Through Hypertext: The MSDS HyperGlossary, Spring 2006 ConfChem, <http://www.ilpi.com/msds/ref/confchem.html> (last accessed August 2012).;
10. Belford, R. & Killingsworth, C., Hyperglossary Generating Program with Wiki Content and Modifiable JavaScript Automated Search Functionality, Fall 2006 CCCE Newsletter, [http://www.ualr.edu/rebelford/ccce/belford\\_cccenl.htm](http://www.ualr.edu/rebelford/ccce/belford_cccenl.htm) (last accessed September 2012)
11. National Science Digital Library, <http://nsdl.org/> (last accessed September 2012)

## Students' Proceeding in Real and Virtual Guided Inquiry Environments

Meike BERGS, Maik WALPUSKI

University of Duisburg-Essen, Chemistry Education, Schuetzenbahn 70- 45127 Essen Germany  
E-mail: meike.bergs@uni-due.de, phone 0049 201 183 4406, fax 0049 201 183 2443

### Abstract

Ever since computer-based experiments have been introduced to the science classrooms, there have been debates on the (dis)advantages, and if they can ever supersede real experiments. The focus of the project at stake is somewhat different: Is there a possibility to combine real and virtual learning environments in order to achieve a full scale advancement of students' Scientific Inquiry skills? How can the treatments advance students' skills individually based on prior knowledge of subject, topic, lab methods, and metacognitive abilities? 300 pairs of students of German intensified education schools were exposed to one out of four different combinations of experimental environments. In learning outcome based on pre-post tests, no significant differences were found. To clarify the results, process data (videotapes or log files and audiotapes) were collected. A method was developed with which both types of process data can be analyzed at in an equally fruitful way. First results are that there are differences with respect to the number of experiments conducted, and usage of strategies, although product data were not significantly different between groups. One possible explanation is that time-on-task is more important than the number of experiments conducted. Further analyses are to be conducted.

### Key words

Scientific Inquiry, Cooperative Learning, Video Analysis, Computer-Based Experiments.

### 1. Introduction

*Scientific Inquiry* demands high standards of students' cognitive abilities, lab skills, and knowledge on the nature of science (Akerson, 2008, pp. 18). Nevertheless, its importance for science education is beyond debate. It is more than a mere method for gaining scientific knowledge - the components themselves can be acquired in self-regulated learning. Consequently, *Scientific Inquiry* itself as an ability to gain scientific insight based on empirical evidence and experiments is a learning goal.

### 2. Literature review

#### 2.1 Learning that science is a way of thinking

For learning how to use *Scientific Inquiry*, students need more than declarative subject-specific knowledge. They should be gradually introduced to "Science as a way of thinking" (Abrams, Southerland & Silva, 2008, pp. XV.). This includes understanding scientific research as investigative processes based on hypotheses or ideas in order to explore natural phenomena, active usage of acquired methods in order to train and firmly establish what has been learned, and finally application of methods as research procedures and strategies aiming at gaining scientific knowledge (Abrams, Southerland & Silva, 2008, pp XV-XVIII.)

#### 2.2 Scientific Problem-Solving

One way to look at scientific research processes is that of scientific problem-solving. Klahr and Dunbar (1988) proposed a model of *Scientific Discovery as Dual Search (SDDS)* According to this, in a first step one has to come up with an idea how to solve the problem (search hypothesis space), then conduct an appropriate experiment (search experiment space) and then evaluate the idea based on evidence. This is especially true for those with high prior knowledge on the task. If, however, prior knowledge is low, participants conducted experiments in order to get an idea. Then, again, they tested their idea and

evaluated them. Klahr and Dunbar distinguish between “theorists” (starting by searching hypothesis space, then doing an experiment) and “experimenters” (starting by conducting an experiment in order to get an idea what to look for) (e. g. Klahr, 2000, pp. 62-71.)

Another strategy not exclusively but characteristically applied in science is that of variable control. Tschirgi (1980) found that in everyday situations, already children aged 7 or 8 try to find the cause for a particular event by varying one variable while keeping every other variable constant (VOTAT - vary one thing at a time) which is why she claims that children of that age can be trained to use that strategy. Other strategies such as changing everything or holding one variable constant while changing every other variable (HOTAT – hold one thing at a time) are also chosen but the older children grow, the more they stick to VOTAT (Tschirgi, 1980, p. 7.)

### 2.3 Experimentation in the science classroom

The importance of experimentation in science is also acknowledged by several countries’ education standards not because it is the distinctive feature of science but an important part of science (e.g. the German “Standards for chemistry in general education” (*Bildungsstandards im Fach Chemie für den Mittleren Schulabschluss*), 2005). Yet, experiments seem to be little helpful in constructing subject-specific knowledge, although they are often used for that purpose (e.g. the reviews of studies by Hofstein & Lunetta, 1982; Lazarowitz & Tamir, 1994; Lunetta 1998). A study conducted by Hart et al. (2000) showed that students often do not know why they run experiments at all. As they do not know what to focus on, and an experiment requires bringing together what they know, do, observe, and conclude, they focus on subject-specific knowledge (and fail as reported above.) Hart et al. instead explicitly put the emphasis on the experimentation process in order to give students the opportunity to become familiar with experimentation and lab equipment, and found that students should not only be aware of an experiment’s goal but also of its aim in order to succeed (Hart et al., 2000.)

### 2.4 Real versus virtual experimentation

Real experiments ask for a particular level of manual skills and lab literacy. This is not necessarily true for virtual experiments because developer and programmer can decide on e.g. how fallible an experiment is, or how complex the representation of an apparatus is.

Regarding the authenticity of the lab equipment used, it is common to replace complex apparatuses, and instead just show a screen on which measured values, e.g. the pH-value or a potential, are shown. Thus, students might learn about a subject-specific content without ever having seen authentic equipment.

Another aspect is fallibility. Scientists know well of the problems possibly occurring during experimentation without making major mistakes. How does the virtual experiment deal with that? Just like authenticity of skills required, and the authenticity of equipment, this also depends on the developers and coders (e.g. Clark, 1994; Gunstone and Champagne, 1990; Triona and Klahr, 2003).

### 2.5 Metacognitive abilities and self-regulated learning

Apart from knowledge on how scientific insight is gained best, and a number of manual skills, being able to scientifically inquire also calls for some basic skills in self-regulation. It was proven that instructions concerning self-regulation are much more effective when not given as a note in advance but as prompts during the learning process (e.g. Thillmann, 2007).

## 3. Intentions and Research Questions

The project at hand tries to combine effects from real and virtual learning environments found and developed in projects of Duisburg-Essen university’s research group and graduate school “Teaching and learning of science” (henceforth *nwu-essen*) (see section “Method - Experimental environments”). It also aims at finding whether a combination of real and virtual experiments is more fruitful for components of *Scientific Inquiry* by combining real and virtual experimental environments.

As the project does not only look at learning outcome but also at how students proceed when working with experimental environments, process data analyses are crucial. In former *nwu-essen* projects, these have been either run on video data or on computer-generated logfile data. As described later, the project at



stake generates both. Hence, a method has to be developed with which analyses on both types of process data can be run in order to get comparable results which can then be used for explaining product data. The research questions (RQ) and hypotheses (H) focused on in this paper are as follows:

RQ1 How do different combinations of real and virtual experiments influence the acquisition of different experimentation sub-skills?

H1.1 Experimentation according to *SDDS* is better trained in virtual than in real experiments.

H1.2 *VOTAT* is better trained in virtual than in real experiments.

H1.3 The mode of the experimental environment (real or virtual) has no influence on subject-specific knowledge gain.

H1.4 Manual skills are better trained in real than in virtual experiments.

RQ2 Which explanations for paper-pencil-test results can be drawn from process data?

H2.1 The number of *VOTAT* experiments conducted by individual pairs is positively correlated to scores in *VOTAT* items.

H2.2 The number of experiments conducted according to *SDDS* is positively correlated to scores in *SDDS* items.

## 4. Method and Design

### 4.1 Experimental environments and training

As mentioned above, the experimental environments used in this project were developed and evaluated in former projects. Two disciplines have been concerned with experimentation in the science classroom: the department of educational psychology has put an emphasis on improving virtual *Scientific Inquiry* while the department of chemistry education has put an emphasis on collaborative *Scientific Inquiry* environments. The following characteristics were integrated in the learning environments used in the study at stake: well-formulated learning goals (Künstig, 2007), adaptive meta-cognitive prompts (Thillmann, 2007; Göbbling, 2011; Marschner, 2011), cooperative learning (Rumann, 2005), and a training on *SDDS*-experimentation (Walpuski, 2006; Wahser, 2008).

Two topics (buoyancy, and acids and bases) can be worked on in two different modes (virtually and physically). The modes of the same topics were kept as close to each other as possible, yet there are distinctions referring to the differences between real and virtual experiments mentioned above: some aspects were simplified in virtual experiments (e.g. cleaning the Erlenmeyer flask), some mistakes were impossible to make (e.g. forgetting to note down what has been done so far). Some aspects not observable in real experiments were realised in the virtual experiments (e.g. pictures of ions in the liquids, pressures acting on solid figures in liquids), and some extra features were added (e.g. all the experiments conducted are automatically recorded and can be called up if desired).

### 4.2 Data collection

The pairs of students were randomly assigned to one of the following treatments:

Treatment	1		2		3		4	
	a	b	a	b	a	b	a	b
Experiment 1	VE Acids/Bases	VE Buoyancy	VE Acids/Bases	VE Buoyancy	RE Acids/Bases	RE Buoyancy	RE Acids/Bases	RE Buoyancy
Experiment 2	VE Buoyancy	VE Acids/Bases	RE Buoyancy	RE Acids/Bases	VE Buoyancy	VE Acids/Bases	RE Buoyancy	RE Acids/Bases

Pict. 1: Treatments used.  
*VE* = Virtual mode. *RE* = Physical mode.

In concordance with the experimental environments mentioned, different tests on components of *Scientific Inquiry* were run: two different tests on scientific discovery processes, and two tests on subject-specific knowledge, a test on motivation, tests on subject-specific knowledge for both topics. All these tests were run at least twice (as a pre-test and after the intervention was completed), one of the tests on scientific discovery was also run after the training lesson. As additional control variables, a scale of Heller & Perleth's KFT (Cognitive Abilities Test) (2000) was run, and on the day the intervention took place, the classes completed a questionnaire on motivation in the morning and after they had worked on the second environment. All these tests were multiple choice tests. In order to measure the different impact real and virtual experiments have on students' lab skills, a test was developed in which students are not only asked to manually work with the equipment provided in the interaction boxes but also to answer questions on mistakes typically made when using the equipment. In this test, students have to give short answers.

Apart from the tests, process data were collected: the computer-based trainings generated log files, while students working on real experiments were video-taped. Additionally, a number of pairs working with the virtual experiments were audio-taped in order to get more information on whether or not students note every idea and conclusion due to a master thesis (Kreiter, 2010) in which it was shown that there might be discrepancies possibly influencing the calculation of learning outcome. Of those pairs working with real experiments the notes taken on experiments and the pictures of the concept maps drawn are also taken into account.

The pairs tested are year 8-students of schools of intensified general education (Gymnasium). 22 classes were tested (N=300 pairs). The first study (N=16 classes) was run September - December 2010. Another study with slightly varied material in the buoyancy box was run in spring 2012 with another 6 classes.

## 5. Results

Most of the tests showed an appropriate reliability (see table 1). The subject-specific knowledge tests as well as the lab skills tests contained a very limited number of items; as this might be the reason for the low reliabilities; more items were included in an additional study whose results have not yet been analysed.

The first main finding is that the differences between post- and pre-test scores for the whole sample are significant for most of the tests (see table 1), so all the treatments are successful. The test on Scientific Proceeding shows no development at all, reasons are to be clarified. The Motivation survey shows a significant decrease in motivation:

**Table 1:** Results

Test	N	$\alpha$ (Post)	Mean Pre ( $\pm$ SD) Mean Post ( $\pm$ SD)	T-test
Steps in scientific discovery	380	.823	11.38 $\pm$ 4.092 13.89 $\pm$ 3.513	$t(379)=-10.278$ , $p<.001$
Scientific proceeding	380	.788	24.99 $\pm$ 4.698 24.95 $\pm$ 5.501	$t(379)=.124$ , $p=.901$
Lab skills (items acids/bases)	367	.614	10.15 $\pm$ 3.591 13.37 $\pm$ 3.807	$t(366)=-16.492$ , $p<.001$
Lab Skills (items buoyancy)	367	.499	6.89 $\pm$ 2.891 9.09 $\pm$ 2.627	$t(366)=-14.223$ , $p<.001$
Motivation	345	.802	3.97 $\pm$ 1.13 3.54 $\pm$ 1.20	$t(344)=8.386$ , $p<.001$
Subject-specific knowledge (Acids and Bases)	380	.542	1.28 $\pm$ 1.459 3.29 $\pm$ 1.953	$t(379)=-17.663$ , $p<.001$
Subject-specific knowledge (Buoyancy)	380	.550	2.09 $\pm$ 1.617 2.94 $\pm$ 1.848	$t(379)=-17.663$ , $p<.001$

Contrary to the hypotheses, the only significant difference between treatment groups can be found with respect to motivation. Here, group 6 shows a significantly smaller decrease than group 1.

## 6. Summary and Lookout

The intervention study showed that we can enhance students' experimentation skills effectively by using real as well as computer-based experiments. Thus, an important finding was replicated. However, in the analyses run so far, differences between groups were not significant. More analyses on group effects will have to be run in order to get some answers on RQ 1 (How do different combinations of real and virtual experiments influence the acquisition of different experimentation sub-skills?)

Some classes with slightly modified material have been tested in 2012. The data from this second study will have to be analysed as well in order to see if the modification leads to a higher learning outcome.

Additionally, the process data will be analyzed by using one coding manual for both videos and logfile data. At the moment, the data are prepared. The processes will be plotted in graphs which will then be categorized. The number of entries in the different categories will then be analysed quantitatively. One aim is to find whether process- and product-data results can be correlated (RQ2: Which explanations for paper-pencil-test results can be drawn from process data?)

## 7. Acknowledgement

This project is funded by DFG (Deutsche Forschungsgemeinschaft), Project WA2829/2-3.

## 8. References:

1. E. Abrams, S. Southerland, P. Silva (eds.), *Inquiry in the classroom. Realities and opportunities*. Information Age Publishing, Inc., Charlotte 2008.
2. V. Akerson, How do I do this? Skills students need for Inquiry. In: E. Abrams, S. Southerland, P. Silva. (eds.). *Inquiry in the classroom. Realities and opportunities*. Information Age Publishing, Inc., Charlotte (2008).
3. R.E. Clark, *Educational Technology Research and Development*, 1994, 42, 21–29.
4. J.M. Gößling, *Autonomous discovering experimentation - Effects of strategy usage on learning outcomes* (German title: *Selbständig entdeckendes Experimentieren - Lernwirksamkeit der Strategieranwendung*.) Dissertation, Duisburg-Essen University. <http://duepublico.uni-duisburg-essen.de/servlets/DerivateServlet/Derivate-25874/Dissertation.pdf>, 2011.
5. R.F. Gunstone, A.B. Champagne, *Promoting conceptual change in the laboratory*. In E. Hegarty-Hazel (ed.): *The Student Laboratory and the Science Curriculum*, pp. 159–182, Routledge, London (1990).
6. C. Hart, P. Mulhall, A. Berry, J. Loughran, R.F. Gunstone, *Journal of Research in Science Teaching*, 2000, 37, 7, 655-675.
7. K.A. Heller & Ch. Perleth, *Cognitive Abilities Test for Years 4-12*, revised (German title: *Kognitiver Fähigkeitstest für 4.-12. Klassen, Revision (KFT 4-12+ R)*). Hogrefe, Göttingen 2000.
8. A. Hofstein, V.N. Lunetta, *Review of Educational Research*, 1982, 52, 201-217.
9. D. Klahr, *Exploring Science. The Cognition and Development of Discovery Processes*. The MIT Press, Cambridge 2000.
10. D. Klahr, K. Dunbar, *Cognition Science*, 1988, 12, 1-55.
11. J. Künsting, *Influences on self-regulated learning. The role of subject-specific knowledge for helpful strategy usage, and a comparison of four kinds of learning goals in experiments*. Dissertation, Duisburg-Essen University. VDM, Saarbrücken 2007.
12. R. Lazarowitz, P. Tamir, *Research on using laboratory instruction in science*. In D. L. Gabel. (Ed.) *Handbook of research on science teaching and learning*, pp. 94-130. Macmillan, New York (1994).
13. V.N. Lunetta, *The school science laboratory: historical perspectives and centers for contemporary teaching*. In P. Fensham (Ed.). *Developments and dilemmas in science education*, pp. 169-188, Falmer Press, London (1998).
14. J. Marschner, *Adaptive feedback for supporting self-regulated learning with experiments* (German title: *Adaptives Feedback zur Unterstützung des selbstregulierten Lernens durch Experimentieren*). Dissertation, Duisburg-Essen University. [http://duepublico.uni-duisburg-essen.de/servlets/DerivateServlet/Derivate-27679/Diss\\_Marschner.pdf](http://duepublico.uni-duisburg-essen.de/servlets/DerivateServlet/Derivate-27679/Diss_Marschner.pdf), 2011.
15. S. Rumann, *Collaborative learning in the chemistry classroom* (German title: *Kooperatives Lernen im Chemieunterricht*). Dissertation, Duisburg-Essen University. Logos, Berlin 2005.
16. Sekretariat der Ständigen Konferenz der Kultusminister der Länder in der Bundesrepublik Deutschland (ed.). *Bildungsstandards im Fach Chemie für den Mittleren Schulabschluss*. Luchterhand, Munich 2005.
17. H. Thillmann, *Self-regulated learning through experimentation: from logging to empowering*. (German title: *Selbstreguliertes Lernen durch Experimentieren: Von der Erfassung zur Förderung*). Dissertation, Duisburg-Essen University. [http://duepublico.uni-duisburg-essen.de/servlets/DerivateServlet/Derivate-18970/Dissertation\\_Thillmann\\_online-Version.pdf](http://duepublico.uni-duisburg-essen.de/servlets/DerivateServlet/Derivate-18970/Dissertation_Thillmann_online-Version.pdf), 2007.
18. L. Triona, D. Klahr, *Cognition and Instruction* 2003, 21, 149–173.
19. J.E. Tschirgi, *Child Development*, 1980, 51, 1-10.

20. I. Wahser, Structuring Training to Deal With Mistakes in Process-orientated Learning in Small Groups in Chemistry Education (German title: Training naturwissenschaftlicher Arbeitsweisen zur Unterstützung kooperativer Kleingruppenarbeit im Fach Chemie). Dissertation, Duisburg-Essen University. Logos, Berlin 2008.
21. M. Walpuski, Process-oriented experimental chemistry learning in small groups. (German title: Optimierung von experimenteller Kleingruppenarbeit durch Strukturierungshilfen und Feedback). Dissertation, Duisburg-Essen University. Logos, Berlin 2006.

## An International Comparison of Scientific Inquiry: A Video Study in Chemistry Lessons in Germany and Sweden

**Jaana BJÖRKMAN, Rüdiger TIEMANN**

*Humboldt-Universität zu Berlin, Department of Chemistry, Chemistry Education  
Brook-Taylor-Street 2 -12489 Berlin, Germany  
ruediger.tiemann@chemie.hu-berlin.de  
Tel.: 0049302093/7510 Fax: 0049302093/7482*

### Abstract

*Despite the central role of Scientific Inquiry within science education, in reality it occurs rather rarely within science lessons in Germany. A comparison with a school system (such as the Swedish one) that emphasises Scientific Inquiry in a stronger way enables the identification of culture-specific teaching patterns in terms of the instruction of processes of science, in other words Scientific Inquiry. This suggests an international comparison of German and Swedish (chemistry) lessons.*

*The design of the descriptive study is a category-led video analysis. The video study will be conducted with a total sample of 32 video-recorded chemistry double lessons in Germany and Sweden. 20 double lessons of 10<sup>th</sup> grade (age of 15/16) grammar school classes will be video-recorded and analysed in Germany and further 12 double lessons of 9<sup>th</sup> grade (15/16) primary school classes in Sweden. The variables of the coding manual include the surface structure and the deep structure concerning Scientific Inquiry.*

*First results of the Swedish video sample show that the teachers focus mostly on planning and performance of investigations. Phases concerning the formulation of the research question and the hypothesis as well as the reflection of the process occur rather rarely. This leads to the conclusion that the recorded chemistry lessons demonstrate an unbalanced distribution in terms of the organisation of Scientific Inquiry. Furthermore, it indicates that Scientific Inquiry is only partly realised in Swedish chemistry lessons, despite the importance within scientific thinking. Moreover, these results clarify the relevance of further investigations in the field of Scientific Inquiry.*

**Keywords:** Scientific Inquiry, video analysis, international comparison, Chemistry Education

### 1. Background & Framework

Nowadays one of the most important goals in science education is to provide a basic scientific understanding in terms of socially and politically relevant issues. This enables students to participate in these issues in a critical way [1]. One way of providing these skills is the concept of *Scientific Inquiry*. *Scientific Inquiry*, which illustrates one kind of scientific thinking, is formed of three stages [e.g. 2-4]:

- 1) formulation of scientific questions and hypotheses
- 2) planning and performance of investigations
- 3) data analysis and reflection of investigations

Despite the fact that these three steps play a central role in science education, in reality this occurs in less than 10% of the time [5]. Another study indicates that experiments are not often integrated within *Scientific Inquiry* [6]. These findings show an increased need for research in the field of *Scientific Inquiry* in science lessons. This can be realised through an investigation in terms of the organisation of the process of *Scientific Inquiry* in classroom situations.

Furthermore, this analysis allows a critical confrontation and reflection concerning teaching processes [7]. Thus, only the analysis of typical international teaching scripts provides an identification of teaching patterns in teaching processes and – more important – makes them changeable [8]. Consciously perceived

teaching processes can be identified in a more objective way, which makes it possible to compare cultural specific patterns with the teachers' own teaching practice [7]. Consequently, it requires primarily a comparison to identify teaching patterns, due to the fact that teaching processes cannot be considered isolated. In other words, to analyse the implementation of *Scientific Inquiry* in classroom situations it is necessary to compare German lessons with lessons of a country that puts more emphasis on *Scientific Inquiry*. Internationally, there are considerable differences in the integration of the concept of *Scientific Inquiry* into different school systems [9]. There are European countries such as Sweden which integrated this concept much earlier into their curricula, compared to Germany [10]. This suggests an international comparison between chemistry lessons in Germany and Sweden to investigate culture-specific teaching processes in terms of the organisation of *Scientific Inquiry*.

## 2. Purpose & Research Question

The aim of the project is to analyse *Scientific Inquiry* in chemistry lessons in Germany and Sweden. In addition, a key interest of this study is to investigate influences on the level of the organisation of *Scientific Inquiry*.

The following main question is addressed in the context of this paper:

How is *Scientific Inquiry* organised in Swedish chemistry lessons?

## 3. Method and Design

The design of this descriptive and exploratory study is a low-and high-inference category-led video analysis. This is done with a pseudo-randomised sample of videos of German and Swedish chemistry double lessons. This video study will be implemented with a total sample of 32 video-recorded chemistry double lessons in Germany and Sweden. 20 double lessons of 10<sup>th</sup> grade (age of 15/16) grammar school classes were video-recorded and analysed in Germany and further 12 double lessons of 9<sup>th</sup> grade (age of 15/16) primary school classes in Sweden. Moreover, the teachers were asked to integrate a scientific investigation within the video recorded chemistry lesson.

To analyse the video recorded lessons there were used variables of a coding manual regarding the surface structure (classroom management, teachers' and students' statements and variables of the experimentation process), which have been developed and tested in previous investigations [11]. Additionally Björkman & Tiemann [12] constructed a coding manual for the detailed analysis of the phases of *Scientific Inquiry*. The coding manual includes 23 variables with three to twelve categories describing phases of the formulation of the research question and hypothesis, the planning and performance and the analysis and reflection of the investigation. Most of the variables of the coding manual show very good ( $.75 < \kappa < 1.0$ ) and appropriate ( $.60 < \kappa < .75$ ) inter-rater-reliabilities. In general, the coding manual represents a reliable tool to investigate the research question of this study. Variables with low inter-rater-reliabilities, belonging mostly to the variables of the research question and hypothesis, were better described and operationalized more precisely [12].

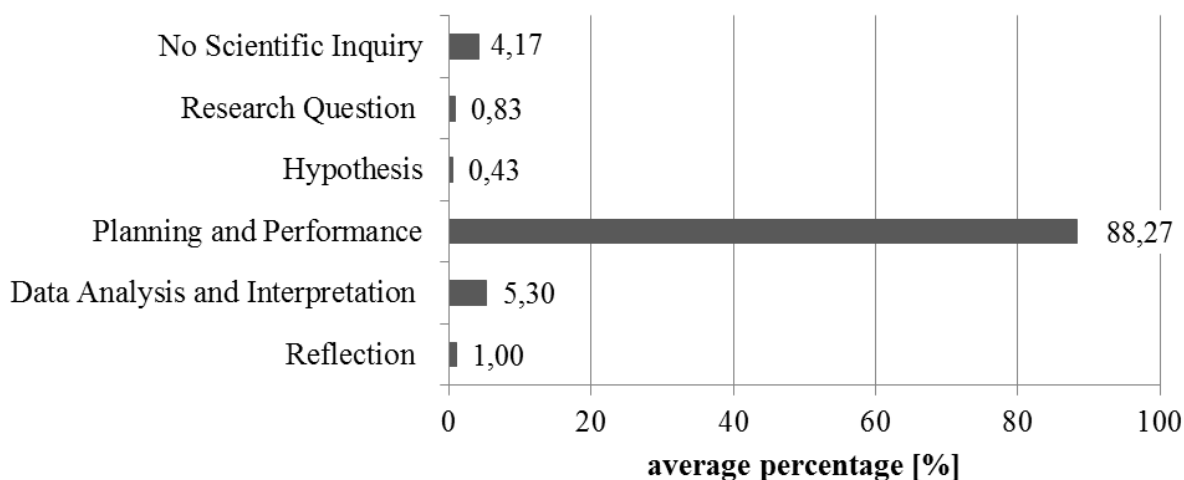
The video recorded lessons were analysed with the behavioral observation software Observer XT 10<sup>®</sup>, which enables the behavioral analysis as well as the statistical evaluations.

In addition, a teacher questionnaire recorded the demographic data, school climate, teaching methods and views on *Scientific Inquiry*. A student questionnaire collecting the control variables demographic data, cognitive skills, the background knowledge, the scientific interest and motivation and the views and skills in *Scientific Inquiry* was used in this study.

## 4. Results

This paper presents the preliminary results of the Swedish sample. Analysing the general occurrence of the phases of *Scientific Inquiry* (Figure 1), an unbalanced distribution concerning *Scientific Inquiry* is obvious. But it is not surprising that the planning and performance phase shows such a high percentage, because of the demand on the teachers to integrate an investigation within the recorded double lesson. This phase differs significantly towards all other phases of the process with high effect sizes ( $r = .99^{***}$

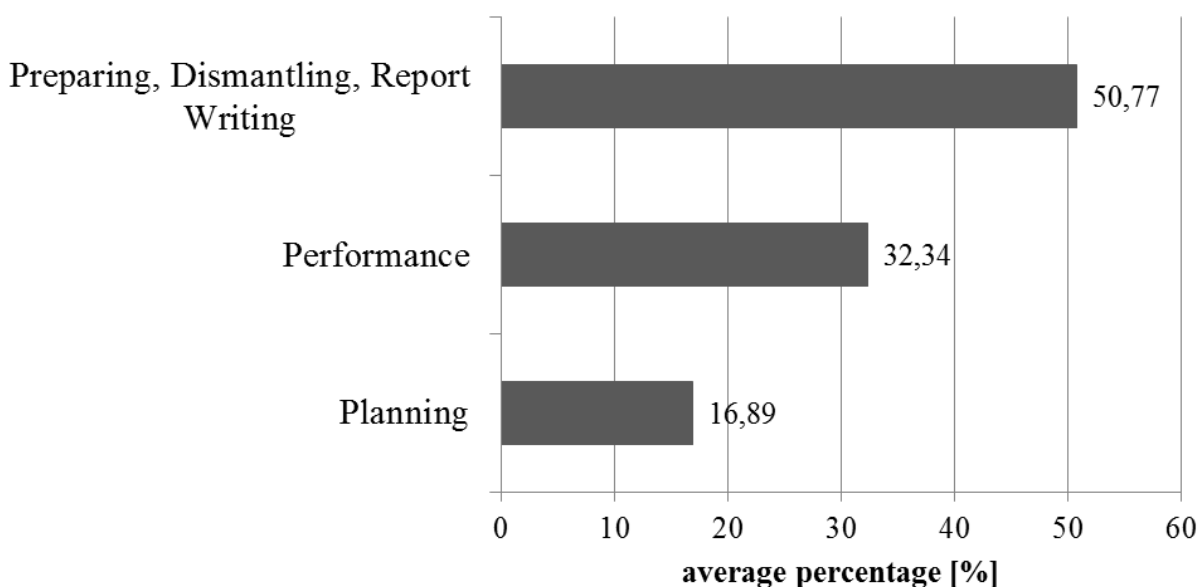
for each phase).



**Figure 1.** Average percentage of the phases of *Scientific Inquiry* in Swedish chemistry lessons (N = 12)

Furthermore, the phase concerning the data analysis and interpretation shows significant differences towards the occurrence of the research question, hypothesis and reflection with medium effect sizes ( $r = .68^* - .77^{**}$ ).

The planning and performance phase can be divided in the planning phase, the performance phase and the phase of the preparation, the dismantling and the report writing (Figure 2).

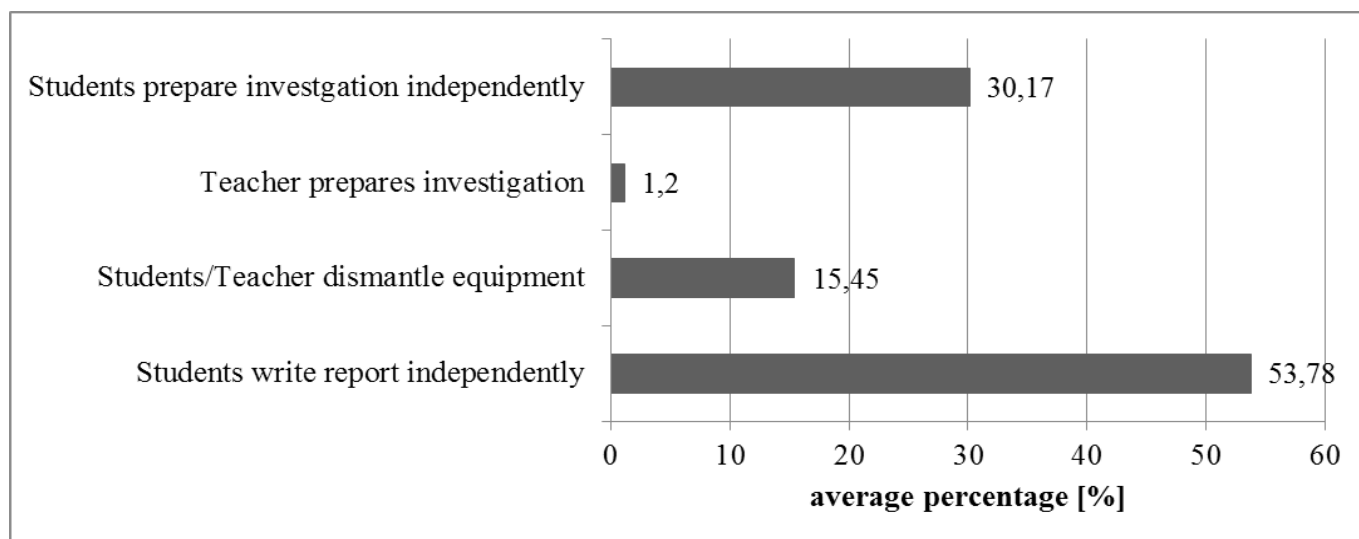


**Figure 2.** Average percentage of the distribution concerning phases planning, performance and preparing, dismantling and report writing in Swedish chemistry lessons (N = 12)

Figure 2 shows a high percentage of the phase, where students prepare the investigation, dismantle their equipment or write the report concerning the investigation. Furthermore, this proportion differs significantly towards the planning phase with a high effect size ( $.92^{***}$ ).

Due to the fact that this phase contributes significantly within the phase of planning and performance it is important to analyse it in detail. Thus, this phase can be divided in the categories “Students prepare investigations independently”, “Teacher prepare investigation”, “Students/Teacher dismantle equipment”

and “Students write report independently” (Figure 3).



**Figure 3.** Average percentage of the phase of preparing, dismantling and report writing in Swedish chemistry lessons (N = 12)

The report writing along with the students’ preparation phase differ significantly towards the teachers’ preparation and the dismantling phase. It shows that a lot of time is given to students in order to prepare an investigation as well as to document their results. However, as figure 1 showed, a respectively low average percentage in terms of the data analysis and the interpretation can be stated.

## 5. Conclusion

It is of great importance to integrate the process of *Scientific Inquiry* within chemistry lessons and establish a balanced distribution concerning all phases of the process. Evaluating the video recorded chemistry lessons in Sweden, it shows that the Swedish teachers generally focus on the planning and performance phase. Whereas the formulation of the research question, the hypothesis and the reflection occur respectively rarely. An explanation for that can be found in the short amount of time, which is available for the teacher as well as the difficulties students and teacher have formulating the research question and the hypothesis.

Within the dominating planning and performance phase the class mostly performs the investigation, prepares, dismantles or writes reports in relation to the investigation. The average percentages of the preparation and the report writing show the highest amount. The high average percentage of the report writing phase and the low average percentage of the data analysis and interpretation phase support the finding that within the *Scientific Inquiry* process planning and performance are focussed instead of the discussion of results.

In summary, the video recorded Swedish chemistry lessons show a first impression of the problems and difficulties in teaching *Scientific Inquiry*.

## Bibliography

- [1] W. Gräber & P. Nentwig: Scientific Literacy - Naturwissenschaftliche Grundbildung in der Diskussion [Scientific Literacy – Scientific Literacy in discussion]. In Gräber, Nentwig, Koballa & Evans (eds.) *Scientific Literacy*, pp. 7-20. Leske + Budrich, Opladen, (2002)
- [2] D. Klahr, *Exploring Science. The Cognition and Development of Discovery Processes*, MIT, Cambridge 2000
- [3] A. Hofstein, *Chem. Educ. Res. Pract.*, 2004, DOI: 10.1039/B4RP90027H
- [4] J. Mayer: Erkenntnisgewinnung als wissenschaftliches Problemlösen [Scientific Inquiry as scientific problem solving]. In: Krüger, & Vogt (eds.) *Theorien in der biologiepädagogischen Forschung*, pp. 177-186. Springer, Berlin/Heidelberg (2007)
- [5] T. Reyer, Oberflächenmerkmale in Unterricht. Exemplarische Analysen im Physikunterricht der gymnasialen Sekundarstufe [Surface features in teaching: exemplary analyses of physics lessons in upper secondary education], Logos-Verlag, Berlin 2004.



- [6] M. Tesch & R. Duit: *ZfDN*, 2004, 10, 51-69
- [7] T. Seidel, *Lehr-Lernskripts im Unterricht. Freiräume und Einschränkungen für kognitive Lernprozesse - eine Videostudie im Physikunterricht* [Teaching and learning scripts. Free spaces and restrictions for cognitive learning processes – a video study in physics education], Waxmann, Münster 2003
- [8] C. Pauli & K. Reusser, *UW*, 2003, 31, 238-272
- [9] G. Strobl: *Naturwissenschaftliche Bildung - fachorientiert oder Fächer übergreifend* [Scientific Literacy – subject-oriented or interdisciplinary]?. In: Ohly & Strobl (eds.) *Naturwissenschaftliche Bildung*, pp. 31-45. Beltz Verlag, Weinheim (2008)
- [10] The Swedish National Agency for Education: *Vad händer i NO-undervisningen* [What happens in science education]?. <http://na-serv.did.gu.se/amnesdid/pdf/kap1/CKBFrev.pdf>. Accessed 20 August 2012
- [11] T. Seidel, M. Prenzel, R. Duit & M. Lehrke (eds.) *Technischer Bericht zur Videostudie „Lehr-Lern-Prozesse im Physikunterricht“* [Technical report of the video study “teaching and learning processes in physics education“], IPN, Kiel 2003.
- [12] J. Björkman & R. Tiemann, *Jahrestagung der Gesellschaft für Didaktik der Chemie und Physik* [Annual meeting of the “Gesellschaft für Didaktik der Chemie und Physik“], Oldenburg, September 2011, pp. 304-306

## Development of a Training Module for Future Chemistry Teachers on Education for Sustainable Development

Mareike BURMEISTER and Ingo EILKS

*University of Bremen, Germany*

*University of Bremen, Dep. of Biology and Chemistry, Leobener Str. NW 2, 28334 Bremen, Germany, mburmeister@uni-bremen.de, +49 421 218-63280/8*

### Abstract

*This paper reports a project of Participatory Action Research to innovate chemistry teacher education. A course module on sustainability issues and Education for Sustainable Development was developed, cyclically refined, and implemented in German pre-service chemistry teacher training. An overview on the course module will be given. Experience gained during its three-year development will be reflected upon. A short insight into the evaluation will be reported.*

**Keywords:** Chemistry Teacher Education, Education for Sustainable Development, Participatory Action Research

### Participatory Action Research for innovating chemistry teacher education

For almost a decade now the model of Participatory Action Research (PAR) developed by Eilks and Ralle [1] has been used for chemistry education curriculum development and classroom research (e.g. [2-3]). PAR seeks to thoroughly connect domain-specific educational research with curriculum development and teaching practice. PAR is performed in collaborative groups of in-service teachers and accompanying educational researchers from the field of chemistry education. The project described in this paper represents one of the first approaches for applying the PAR model to innovations for higher education.

Just like in the case of focusing school chemistry education, PAR for higher education seeks a cyclical optimization of teaching practices, which are supported by research about teaching and learning processes in the specific domain, reports of practitioners' personal experience, and the intuition and creativity of experienced people in the field. The objectives targeted in the PAR process encompass newly-developed curricula, teaching strategies and empirical evidence about teaching and learning in the field. They also include the reduction of any deficits reported from practice, and will result in better-trained professionals (Figure 1).

Every sort of Action Research is cyclical in nature. In PAR, new teaching approaches are designed, then cyclically applied, tested and revised. The objective is to improve teaching practices by applying newly-developed and cyclically improved lesson plans in different testing groups. The prototype designs are used and tested as early as possible to see if they have the potential to reduce the identified problems in classroom practice. The process of planning in a group is an important factor. This is not just because problems in evaluation can be avoided, but also because communication and reflection within the group ensure that each design is compatible with the needs of everyday teaching practices.

The research process in the PAR model is thought to be initiated when deficits in either teaching practices or empirical research are reported upon. PAR is then used to determine methods for eliminating or reducing any problems in teaching practice. This is also the case when transferring PAR to the realm of higher education. Research begins with a thorough analysis of the relevant literature. Group discussions within the research team are used to determine whether or not the problem is of general interest in authentic practice and beyond individual classrooms. The discussions also reflect whether information from the literature is considered of potential for the structuring of altered curricula or pedagogies within the specific, authentic educational settings the practitioners work in.

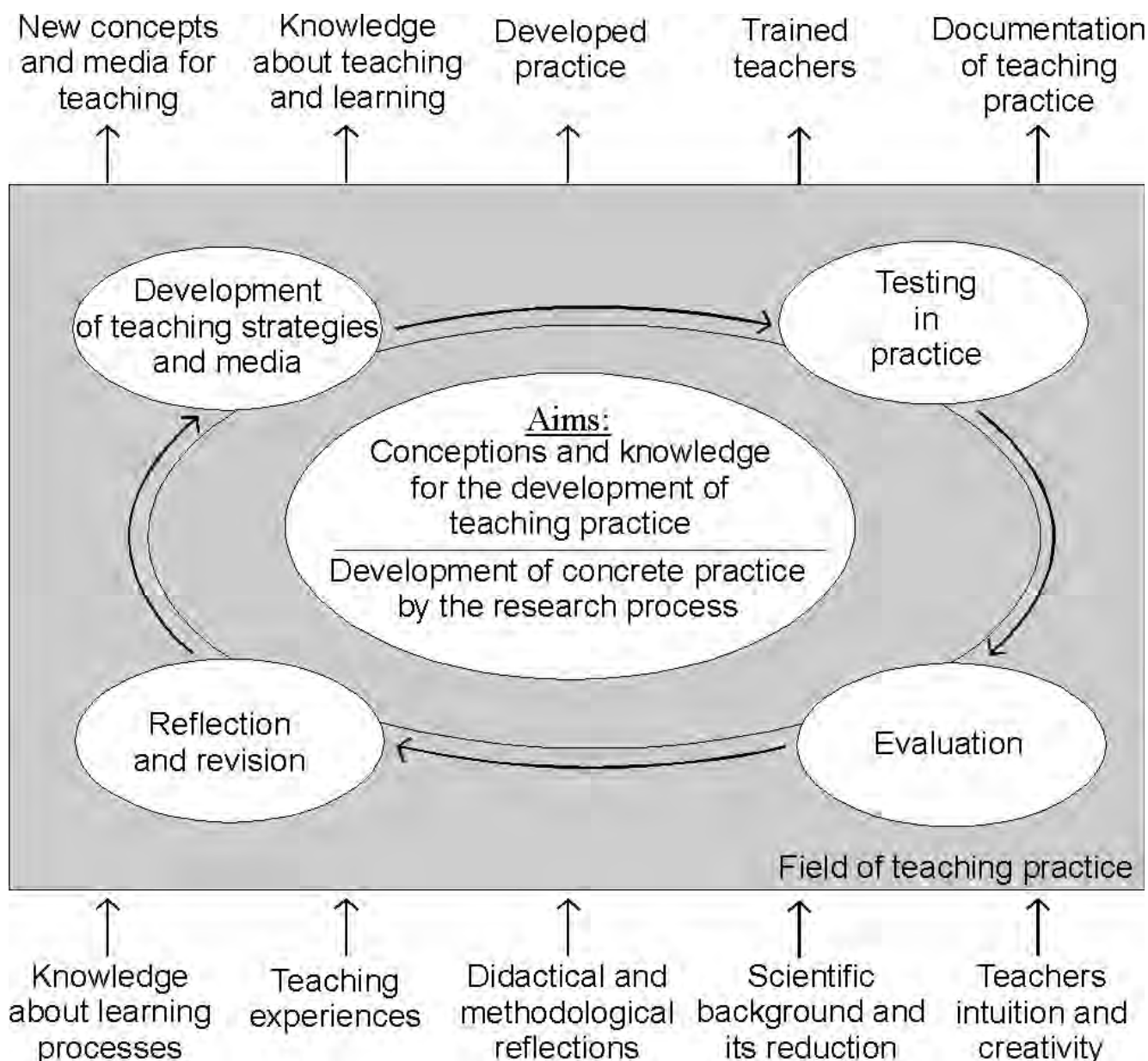


Fig. 1: Participatory Action Research within domain-specific education [1]

In the case described here, the problem analysis showed many official documents (as discussed in [4]) which called for a more thorough implementation of course content on Education for Sustainable Development (ESD) in pre-service teacher training. Literature analysis supports claims that the implementation of subject matter addressing both sustainability theories and learning about ESD in chemistry teacher preparation is insufficiently developed in many countries (e.g. [5]). This is why the cyclical PAR process was started and eventually led to three developmental cycles in three consecutive years of testing. However, hard empirical evidence and concrete information about student teachers' prior knowledge, attitudes and beliefs concerning sustainability and ESD to inform the curriculum development process in the case of German chemistry education were hard to come by at the beginning of the process. To overcome the lack in empirical support, own empirical research initiatives were started in parallel to the curriculum innovation. The empirical research was meant to interact with and influence both curriculum development and the participants' understanding of its effects.

### **Accompanying empirical analysis**

Research on teachers' overall knowledge base, attitudes and beliefs concerning sustainability concepts and ESD is rare in the literature. Based on the few available studies from Germany and other countries (e.g. [5-7]), one can assume that German (student) teachers' knowledge of sustainability issues and the theories behind sustainable development might remain underdeveloped. The same seem to hold true for the curricula and pedagogies developed for ESD-driven chemistry teaching. Anyhow, for the case of chemistry education in the German context such documentation was not available prior to this project. That is why the development of the course module was accompanied by empirical research in order to support the curriculum development process. Two studies based on questionnaires were conducted to describe German chemistry student teachers (N= 87) and trainee teachers' (N=97) knowledge base and attitudes towards sustainability and the didactics and pedagogies of ESD.

Both studies found positive attitudes among the student teachers and teacher trainees with regard to strengthening the contemplation with sustainability issues and ESD in secondary school education. The participants acknowledged that all school subjects should contribute to ESD, but they also believed in a specific responsibility of chemistry education. Despite this positive attitude, their overall knowledge about potential topics and pedagogies was limited and poorly thought out. There seems to be a lack of theoretically sound ideas about modern concepts of sustainability, as well as about a theory of ESD. Nevertheless, many student teachers and teacher trainees were headed in the right direction when asked for their knowledge about and association with sustainability and ESD. But their ideas were raw, undeveloped and unsupported by substantial knowledge or theory. Only a small minority of the participants in these two studies was able to outline a more-or-less sound description of what is meant by sustainable development. Almost no one had heard or could repeat what a theoretically-based description of ESD actually entails.

Overall, most future chemistry teachers in the two case samples acknowledged that secondary school education should promote ESD, and that chemistry education should be a part of it. Some were able to intuitively associate topics from the chemistry curriculum with issues of sustainable development, e.g. with the question of the sustainable production of fuels. Yet ideas for using ESD in chemistry education, including how teaching might be structured by adequate pedagogies, remained very limited. Both samples explicitly mentioned that the participants had not yet been confronted with learning about sustainability or ESD pedagogies during their teacher training program. Both issues seem to play hardly any role in many of the German chemistry teacher training programs. Neither chemistry courses, nor educational and domain-specific educational courses seem to address these issues explicitly so far. The participants mentioned that the major sources of their knowledge had been from informational settings such as TV and the Internet. This strongly supports the premise of the current study that the development of explicit course content and modules to strengthen pre-service teachers' theoretical and practical knowledge for applying ESD are desperately needed in the field of chemistry education. It became clear that a theoretical foundation needs to start from the very bottom and has to include both learning about sustainability as such, the role of sustainable thinking in chemistry, and knowledge about practical pedagogies for effectively bringing ESD into the chemistry classroom.

### **The structure of the course module**

The course module has a duration of six weeks with one ninety-minute session per week. Table 1 gives an overview of the different sessions. Inspired by the empirical findings described above, the coursework starts with a self-reflection activity. This activity makes the participants explicitly aware of their prior knowledge, their intuitive associations with the topic, and their potential lacks of theoretical foundations. Coming from the exposure of potential deficits in the participants' knowledge, the course then focuses on three major areas of learning:

- The historical development and modern concepts of sustainability in general and their operationalization in chemistry, especially through the concept of Green Chemistry,
- The basic theories and governmental legislations concerning ESD with special focus on the practices of

German chemistry education, and

- Adequate pedagogies for acquainting school students with sustainability thinking in chemistry classes, promoting their understanding skills, and increasing their participation abilities in societal debates on questions of sustainability concerning science and technology.

Contention with the basic theories behind sustainability is introduced through a short lecture, which presents the historical development of the term, the genesis of the Agenda 21, and an overview of competing concepts for modeling sustainability as outlined e.g. in [4]. The central objectives in learning in this phase are understanding (1) that in all modern concepts of sustainability different dimension are interwoven and contain at least the ecological, economic, and social dimensions, and (2) that sustainability always is connected to balancing the interests and needs of today's society with the interests and chances of future generations.

Learning about the point of view on sustainability issues within chemistry is structured using a WebQuest [8]. The WebQuest introduces issues arising from the use of chemistry and the practice of chemical industry connected to sustainable development. It explains chemical industries' efforts to contribute to sustainable development, e.g. by the Green Chemistry initiative, but also presents critical voices. Learning by the WebQuest prepares the participants for a role-play, where both the effort required and the chances represented are talked about by different role-players. The role-play includes discussing critical roles, which question whether the efforts undertaken are carried out in the correct fashion and are sufficiently intense in nature.

**Table 1.** Overview of the course module structure

Session 1	Assessing students prior knowledge and attitudes towards sustainability and ESD using a research questionnaire Lecture on the historical genesis and modern concepts of sustainability Overview on the course and introduction to the WebQuest on the issues of sustainability and Green Chemistry
Session 2	WebQuest on issues of sustainability, the concept of Green Chemistry and its perception in society Role playing of different views towards Green Chemistry, prepared by the WebQuest
Session 3	Jigsaw classroom on educational policy papers about ESD in German school education
Session 4	Analyzing a lesson plan on teaching about plastics with an ESD focus, which mimics the product testing method in order to evaluate plastics in the foreground of sustainability criteria
Session 5	Facultative: Further analysis and discussion of teaching materials Facultative: A board game based on Green Chemistry in the chemical industry
Session 6	Lecture about basic models how to connect ESD and chemistry education Lecture summing up the course content Self-assessment of learning success with reference to the initial questionnaire and data about student teachers' knowledge on sustainability and ESD from the accompanying research Reflection of the course content and structure

Contention with theories of ESD takes place in a jigsaw classroom. The jigsaw classroom is based on different position papers taken from governmental bodies and educational societies, namely from the Conference of the German State Ministries of Education (KMK), the German Society for Educational Sciences (DGfE), as well as the German hub of the UN world decade of Education for Sustainable

Development (Transfer 21). This phase makes clear the importance that educational theory and educational policy gives to ESD.

The next learning phase for how to deal with ESD in school chemistry classrooms is based on a lesson plan developed by a group of teachers in another PAR project especially for this purpose [9]. The lesson plan deals with the topic of plastics and handles the basic chemistry and properties of different polymer materials. The lessons focus on ESD by combining the learning of chemistry content with information on how to evaluate chemistry products and technologies in the foreground of sustainability criteria. Within the lesson the students are familiarized with the three dimensions of modern sustainability concepts. The pupils are asked to mimic consumer test agency workers in order to experience the interconnectedness of the three sustainability dimensions when evaluating chemistry products and technologies. Within the consumer test agency method, participants are asked to evaluate different sorts of plastics (PVC, PET and TPS) currently addressed by the sustainability debate, all of which have ecological, economic and societal implications. The pupils have to weigh the impact of the different products in the various dimensions against one another, evaluate the different plastics, and make a final evaluation. Further analysis of teaching materials or an optional board game dealing with Green Chemistry principles in industrial chemistry [10] are added if time allows.

The course closes with a session reflecting on the achievement and the present status of ESD implementation in German chemistry education. For this purpose the four basic models for implementing ESD in chemistry education as described [4] are presented. This phase also refers back to the participant questionnaires, which were filled out at the beginning of the course which are now related to the empirical findings on the student teacher and teacher trainee knowledge discussed above.

### **Feedback from the participants**

The course was applied in three cycles of development during three consecutive years of study. A total of 46 student teachers participated in the course. The different rounds of testing faced slight variations and improvements in the teaching materials. Feedback was collected by group discussions occurring after the course and written questionnaire with open-ended questions and 32 Likert-items. The evaluation was used for cyclical optimization of the course, including insights into its feasibility and effects.

Overall, the participants responded very positively to the course. The student teachers stated that the course module was interesting, important and valuable for their later profession as chemistry teachers in school. The student teachers also emphasized that they had learned a lot and that they now felt more competent in the area of sustainability and ESD.

Criticism was rare and occurred only briefly in the questionnaires and the group discussions. In the first round of testing individual students were concerned about non-optimal time management of the course and insufficiently recognizable learning objectives for each phase of learning. Some student teachers did not fully recognize the differences in some of the course materials, since some were structured as materials for teacher training while others were materials developed to be used in a secondary school classroom. The different kinds of materials, the roles they were expected to play, and the hoped-for learning outcomes were made more explicit in the second round of testing. Some criticism also arose initially, because certain phases dwelt overly long on political and societal aspects, rather than on chemistry and science factors. The emphasis was then changed by selecting different materials in a later round of testing. Due to improvements in the course structure and materials, criticism in both of these areas diminished in the third round of testing.

### **Conclusions and implications**

Reflecting upon the findings from the accompanying empirical studies we can assume that the current implementation rate of ESD in chemistry education is still low because learning about ESD in connection to chemistry teaching is not a focus of chemistry teacher training in Germany yet. Unfortunately, hard evidence on the current state of concepts believed in and practiced by teachers in German chemistry classrooms is not yet available. Research in this field is still needed; a respective study is under way. But

the fact that almost none of the student teachers brought any developed concept of sustainability with connection to chemistry topics from the school to the university is sobering. This would seem to indicate that such issues are not prominent topics in current chemistry classrooms in German secondary schools and that change is needed.

A second look upon the accompanying empirical study tends to make us assume that ESD practices will eventually be implemented in German chemistry teaching if the prospective teachers are allowed to learn about respective curricula and pedagogies. The contents of the module proved valuable for offering future teachers these ideas and pedagogies for making themselves familiar with sustainability issues. This included the connection of ESD with chemistry topics and modern pedagogies for implementing ESD in chemistry teaching. Student teachers' feedback regarding this innovation was quite positive. The statements made by the participants seem to indicate that future teachers can and will be more sensitive and competent when dealing with sustainability issues and ESD in the chemistry classroom if they are allowed to get a chance to it.

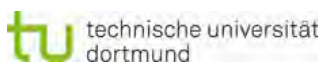
Nevertheless, there is also need that pre-service chemistry teacher training programs must be supported by training in the area of in-service chemistry teacher training with respect to sustainability and ESD. The low implementation rate derived from the empirical studies suggests change. Single parts of the course module described above are currently being used for this purpose, e.g. in-service chemistry teacher training workshops about the WebQuest on Green Chemistry and the lesson plan on evaluating plastics. Perhaps these can contribute further to reducing deficits in in-service teachers' general knowledge about sustainability concepts and ESD in the same fashion as they did for pre-service teachers in this study.

## References

1. I. Eilks, B. Ralle: Participatory Action Research in chemical education. In: B. Ralle, I. Eilks (eds.) *Research in Chemical Education - What does this mean?*, pp. 87-98, Shaker, Aachen, 2002.
2. I. Eilks, S. Markic, T. Witteck: Collaborative innovation of the science classroom by Participatory Action Research – Theory and practice in a project of implementing cooperative learning methods in chemistry education. In: M. Valenčič Zuljan, J. Vogrinc (eds.) *Facilitating effective student learning through teacher research and innovation*, pp. 77-101, University of Ljubljana, Ljubljana, 2010.
3. I. Eilks: Action Research in science education – From a general justification to a specific model in practice. In: F. Rauch, A. Schuster, A. Townsend, T. Stern (eds.) *Bringing a different world into existence: action research as a trigger for innovations*. Routledge, London, accepted for publication.
4. M. Burmeister, F. Rauch, I. Eilks, *Chem. Educ. Res. Pract.*, 2012, 13, 59.
5. M. Summers, A. Childs, *Res. Sci. Techn. Educ.*, 2007, 25, 307.
6. W. Rieß, C. Mischo, *Evaluationsbericht Bildung für nachhaltige Entwicklung (BNE) an weiterführenden Schulen in Baden-Württemberg*, Umweltministerium, Stuttgart, 2008.
7. H.-J. Seybold, W. Rieß, *Environ. Educ. Res.*, 2006, 12 (1), 47.
8. M. Burmeister, S. Jokmin, I. Eilks, *Chem. Kon.*, 2011, 18, 123.
9. M. Burmeister, I. Eilks, *Chem. Educ. Res. Pract.*, 2012, 13, 93.
10. M. Coffey, *Green chemistry: Development of an educational board game*. Paper presented at the Variety in Chemistry Education Conference, York, UK 2011.

## Special Language in Chemistry Education

Hannah BUSCH – Bernd RALLE



TU Dortmund University, Didactics of Chemistry I, Otto-Hahn-Str. 6 - 44227 Dortmund  
 hannah.busch@tu-dortmund.de Tel: 0049 231 755 2930 Fax: 0049 231 755 2932

In the public discussion it seems to be a consensus that scientific literacy is an important part of general education for every human being. It is also mentioned by OECD [1]:

*"Scientific literacy is the capacity to use scientific knowledge, to identify questions and to draw evidence-based conclusions in order to understand and help make decisions about the natural world and the changes made to it through human activity."*

Students should be able to take part in relevant discussions improving their skills of communication. That contains an accurate fluency of speech, a general framework of language and a subject related word pool.

### Abstract

*This article delivers insight into a scientific project, which deals with diagnosis and individual support on the area of special language competencies of secondary school students. The first step of research was to develop and evaluate a tool for analyzing students' competencies. This tool consists of different parts concerning production of words (Association-test), interconnection (linking skills and Concept mapping) and awareness of the meaning of words. It has been applied in several classes in secondary schools lower level. Based on the results of this research options of language support in science classes were designed. In order to do this, cooperation between scientific coworkers and teachers was implemented in the sense of a participatory action research. The support we were aiming at is related to subject matter, language acquisition and individual qualification of the students. Finally, it was evaluated how explicit language support affects students' subject knowledge and general language competencies. Topics of this article will be the theoretical background as well as results and experiences made during developing and proving the tools.*

**Keywords:** Special language, competencies, chemical education, language acquisition, diagnosis, individual support

### 1 Theoretical Background

For passing exams, being successful in education and for the academic career an appropriate language is an important factor for students to learn. But even if students are good at everyday speech they often are in trouble with this special kind of language [2]. To manage everyday life at home, on the playground or with peers Children do not have any problems to communicate to each other. If they have the intention and will to do so, a basic vocabulary and grammar is needed only [3]. The spoken language is supported by many other aspects like gesture or facial expression play. In contrast the academic language should be comprehensible detached from context and situation and should have a high grade of accuracy and specificity. A statement in this area of language should be comprehensible also for a noninvolved person. Regarding to school education the spoken language is expected to be close to the complexity of written speech. It should be comprehensible without nonverbal interaction. A subject specific language also includes a pool of technical terms. These special languages are obligatory bound to subject matter [4]. The difficulty in school practice is that on the one hand language has to be content of learning itself. On the other hand it is the medium to learn subject matters. Thus language competencies have to be applied and shaped at the same time.



Chemistry uses special linguistic features like the other science subjects, too. This leads to a more complex grammatical structure of the written or spoken texts [5, 6]. Practicing chemistry at school we meet different types of language within the different areas of the subject. These types are characterized by a different mixture of general frame and special language [7]. The special academic language in chemical education expected from students contains a medium number of technical terms and a medium level of grammatical complexity. Additional to the criteria of academic school language students have to handle symbolic language (in relation to mathematics and chemistry).

If students understand this special language (vocabulary with chemical meaning and grammar) the arising communication will be beneficial [8]. Finally the overall aim is to be able to phrase subject matters with a little number of words, straight structure and unmistakably, for example when writing a lab report or summarizing and presenting a topic. Regarding to language demands writing a lab report is the most difficult working step in the area of scientific experiments [9].

Different groups of terms can be described according to Vollmer [7] and Rincke [10] by their meanings:

1. Words with only one meaning often seen as "real" technical terms like *molecule* or *ion*. They are commonly used only in relation to the content matters. They normally aren't used in everyday life.

2. Words with more than one meaning, which are commonly used in everyday life and in subject matters. In this field some more differentiation has to be done:

2a. Words with a modified but similar meaning in everyday life and science classes: The modification of the meaning often is a constriction or a generalization. In this case the meaning changes only a little, the connection is still visible. The usage of the technical meaning often doesn't lead to problems in everyday life, because the comprehensibility isn't reduced. The word *salt* for example in everyday life means a special substance (*NaCl* or rather *table salt*). But in science classes a special structure or a family of chemical compounds is meant.

2b. Both meanings are commonly used but the meaning differs in everyday life and science classes, according to situation and context. Because a direct link between the meanings isn't obvious, these type of words causes the most difficulties in understanding for students. On the one hand because well-known words get a second meaning; on the other hand because both meanings are coexisting and still in use. Depending on the conversation one or another meaning is to be activated. For example the word *solution* in everyday context means the result of a task or the way to solve a problem. In science classes a *solution* is described also by the dissolving of solid or gaseous matter in a solvent.

2c. The group of words with a changing technical meaning consists of words that are mainly used in a subject related context. The meaning of these terms changed in the history of chemical development [11], because new inputs were integrated by researches. *Oxidation* for example is connected to different explications. While confronting students willingly and reasoned with different conceptions for one phenomenon, some problems in understanding are initiated automatically.

Subject knowledge is the basis for development students' special language, because without this knowledge words remain meaningless. Verbalization of content knowledge in contrast is impossible without an appropriate repertoire of technical terms. Therefore words in scientific education need to be more than learning vocabulary in the sense of spelling. Additional new meanings have to be generated.

## 2. Beliefs and Thoughts of Chemistry Teachers about Special Language

In order to get information about the thoughts and beliefs of chemistry teachers regarding special language competencies of their students a questionnaire was conducted. It was answered by 32 teachers of lower secondary education in North Rhine-Westphalia.

The questionnaire consists of four sectors: *Importance of different aspects of special language, linguistic emphasis of different activities, difficulties regarding to groups of words and importance of special language for different lesson phases.*

Based on their experience teachers answered that *technical terms* and their *meanings* are the most

important aspects in the area of special language in chemical education. Especially the activities *writing a lab report* and *writing summaries* make great demands on special language competencies. More detailed results can be found in Busch and Ralle [12].

### 3. Diagnosis of Special Language

The intention of these tools is not to judge and mark the students; it is rather understood as an educational diagnostic aid with intention to help teachers making suitable decisions on learning assessments and support. Every tool only shows a small part of the aspired skills by itself and can suitably be used in everyday classes of scientific education. All tools were proved in lower secondary chemistry classes in North Rhine- Westphalia. It can be expected that repeated use will show development and changes of students' competencies.

**Word association:** Students were asked to write down as many associations to a given term as possible. By dividing the words into groups by origin, *everyday experience*, *science class* or *indistinctive origin*, the assessor gets an insight into the level of cross linking and direction of mental bonding. Additionally he gets information about students ability to meaningful to connect different terms meaningful. Words like *solution* commonly used in everyday life, allows a differentiation of students performance in science classes. In contrast the associations of words with only one distinct subject related meaning like *ion* or *molecule* give clear evidence if the term is known or if it is not. The tool 'word association' is suitable when a teacher wants to know what his students connect with one term or another.

**Word connection:** Students were asked to make up a sentence with two given words. Evaluation includes aspects regarding content (*right, imprecise, wrong or no subject related content*) and in relation to language abilities (*spelling, grammar, use of technical terms*).

**Describing word meaning:** In order to learn more about students' thoughts and knowledge about word meaning, it is helpful to ask them to write it down. This approach is insightful for words with more than one meaning. In this case first the everyday meaning is asked and then the subject related one. In this study the term *solution* attracts attention because two-thirds of the students (N= 56 out of 86) were not able to describe the chemical meaning correctly, although the term was linked to the verb *to prepare*. In contrast in everyday life *solution* is always connected with the verb *to find*. Besides the content evaluation the linguistic skills can be checked. In order to do so spelling and grammar can be analyzed or some aspects like personification or validity are of importance.

Every tool of its own gives information about the level of small parts of students' special language competencies. The sum of all tools shows a more extensive picture of the students' abilities. The phase of diagnosis should be complemented by some exercises. Tools for supporting content and language learning are described in the following chapter.

### 4. Support of Special Language Competencies

Within a working framework of participatory action research [13] every tool was proved in chemistry classes several times to support special language. A successful and lasting implementation into chemistry lessons takes place when everyone is aware of problems rising up by inexact use of technical language. Besides small tools like word lists, labeling or key phrases some other instruments seem to be useful. The following tools are developed for usage in chemistry education and were proved in several classes.

**Learning poster lab report:** Writing lab reports needs high demands on language skills and this often causes trouble. In chemistry lessons students are asked to write such reports regularly. Thus a learning poster was designed, which consists of two parts: on the left side there is a differentiation between the three paragraphs of a report (procedure, observation, conclusion) with special linguistic helps. On the right side are general instructions like words that help to organize the time flow or examples for adverbial phrases.

**Cartoons:** Concept Cartoons are well known as a tool for initiating a conversation [14]. They deal mainly

with conceptions of chemistry. In our research they were designed for discussions about the meanings of technical terms. Therefore the speech bubbles are filled with different meanings of one word and the students have to discuss which description is the right one in a given context. They learn a lot about technical terms and scientific discussion. If the students got used to cartoons and asked to create one on their own, the teacher gets special insights into the skills of his students. They can remark hypotheses and assumptions in a protected area. Students can help each other in a kind of peer assessment: find the best way to say it, correcting wrong expressions and creating a better phrasing. Especially the discussions about the best way to say it are really fruitful in the context of word acquisition. They get sensitive and aware of special language and problems that arise from imprecise use of it.

**Rewriting of texts:** In the area of writing texts two different types of challenges were proved: first writing a text with a special addressee like a senior expert or a younger child. The second task is the creation of a text using a different level of symbolization, for example writing a text out of a concept map or a diagram. Students have to rethink their language and to describe technical terms with their own words.

## 5. Conclusion

Supporting linguistic skills, especially regarding the special language competencies is an important task in chemical education. First a well grounded diagnosis is necessary. This article showed some tools to conduct this challenge. Besides the diagnosis individual support is indispensable. With the help of the described tools a teacher can support the acquisition of general and specialized language.

But this approach will only be successful if teachers and students are aware of difficulties that arise from imprecise use of language.

## References

- [1] OECD: Organization for Economic Co-operation and Development, The PISA 2003 Assessment Framework – Mathematics, Reading, Science and Problem Solving Knowledge and Skills, OECD Publishing, Paris, 2003
- [2] J. Cummins, Language, Power and Pedagogy. *Bilingual Children in the Crossfire*, Bilingual education and bilingualism, 23, Clevedon, 2010
- [3] N. Mercer, C. Sams, *Language and Education*, 2006, 20/6, 507-528
- [4] W. Griebhaber, (Fach-)Sprache im zweitsprachlichen Fachunterricht. In: Ahrenholz (eds.) *Fachunterricht und Deutsch als Zweitsprache*, Narr, Tübingen, 2010
- [5] J. Leisen, *Naturwissenschaften im Unterricht Physik* 17, 2006, 95, 9–11
- [6] I. Parchmann, L. Stäudel, *Naturwissenschaften im Unterricht Chemie* 19, 2008, 106/107, 4–9
- [7] G. Vollmer, *Sprache und Begriffsbildung im Chemieunterricht*, Diesterweg, Frankfurt, 1980
- [8] J. Wellington, J. Osborn, *Language and literacy in science education*, Open University Press, Buckingham, 2001
- [9] M.A.K. Halliday, J.R. Martin, *Writing Science: Literacy and discursive Power*. University of Pittsburgh Press, Pittsburgh, 1993
- [10] K. Rincke, *Zeitschrift für Didaktik der Naturwissenschaften*, 2006, 16, 235–260
- [11] H.J. Schmidt, *International Journal on Science Education*, 1998, 13/4, 459–471
- [12] H. Busch, B. Ralle, Special Language Competencies – Diagnosis and individual support. In: I. Eilks, B. Ralle (eds.), *Issues of Heterogeneity and Cultural Diversity in Science Education and Science Education Research*, Shaker Publishing, Aachen, 2012 (in press)
- [13] I. Eilks, B. Ralle, Participatory Action Research in Chemical Education. In: B. Ralle & I. Eilks (Eds.): *Research in Chemical Education - What does it mean?*, Shaker, Aachen, 2002, 87-98
- [14] R. Strenzel, I. Eilks, *Praxis der Naturwissenschaften Chemie* 8, 2005, 54, 44–47

## New methods for exhibiting plastic material through design, research, preservation and educational means: the Plart Foundation (Plastic + Art)

Cecilia CECCHINI

“Sapienza” University of Rome, Faculty of Architecture DATA Department – 70, Via Flaminia 00196 Rome, Italy

Scientific Curator of the Plart Foundation

E-mail [cecilia.cecchini@uniroma1.it](mailto:cecilia.cecchini@uniroma1.it) Telephone number: +39 06 49919018

### Abstract

*The Plart Foundation, opened in Naples in 2008, is an exhibition and research space entirely dedicated to the world of polymeric materials. Historical and contemporary design, as well as experimentation, training and applied research in the field of restoration with polymeric materials can all be found in this place.*

*In addition to these activities, temporary exhibitions of designers and artists whose common denominator is that they all use synthetic materials to create their particular works also take place at the Foundation.*

*The heart of the Plart Foundation is its permanent exhibition space, which hosts one of the greatest collections of polymeric materials objects: 1500 pieces from the first plastics dating back to the end of the 19th century to contemporary design objects.*

*These synergies form a basis for disseminating knowledge about the vast and surprising world of plastic – generally perceived only as cheap and polluting - among a diverse public, from scholars to school children. In fact, for the Plart Foundation education is a central mission: recently, a multimedia section, where visitors discover plastic world and its evolution, has been opened.*

**Keywords:** Plastic in the museum, Chemistry in the museum, Thematic museums, Plastic and design, Plastic and Art

The Plart Foundation, a multifunctional space entirely dedicated to polymeric materials, was inaugurated in Naples in 2008.

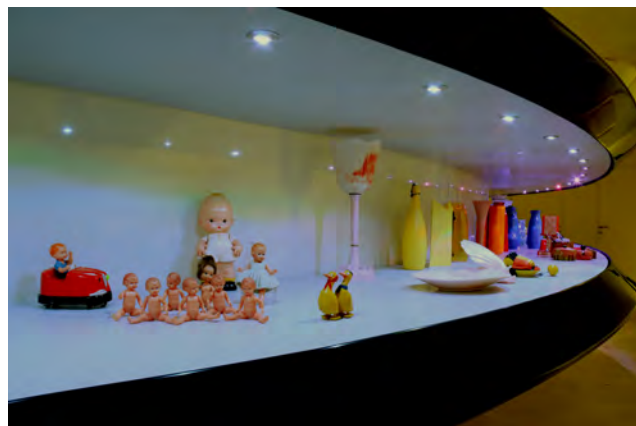
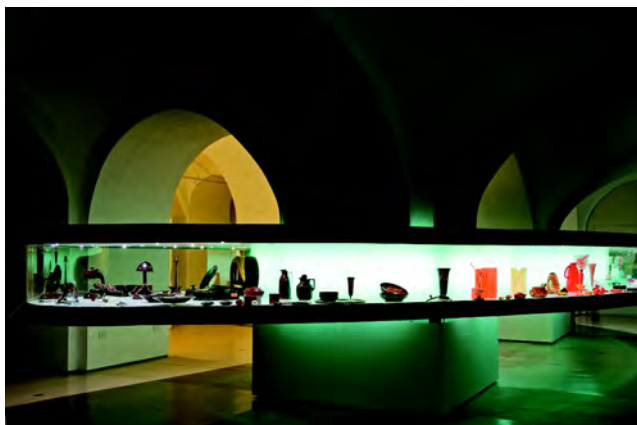
The Foundation premises house a permanent exhibition of one of the richest collections of historical plastics made up of 1500 objects from different periods, specifically from the late-1800s to articles of contemporary design. The collections of objects and works of art is the result of a long and meticulous journey of Maria Pia Incutti, President of the Plart Foundation.

These are flanked by contemporary displays showcasing designers and artists whose common denominator is the use of plastic in creating their works of art. But defining the Plart Foundation as a “museum of plastics” would be inappropriate and simplistic. In fact, its exhibition activities are accompanied by some intense educational and scientific research activities that are especially aimed at the preservation and restoration of polymeric materials.

The array of these activities - in addition to scouting for new talents who employ these materials in an innovative way - produces excellent conditions for the dissemination of correct information regarding polymers to a vast and heterogeneous public: beginning with elementary school children, university students in Italy and abroad collaborating with the Foundation on different projects, occasional visitors and scholars.

The latter also have access to the Foundation laboratories, its specialized library and warehouses where items belonging to the collection and not on display are preserved in excellent conditions. Therefore a place where the extensive and heterogeneous family of plastic material is investigated extensively, according to the most advanced exhibition criteria.

The exhibition layout of the permanent collection in fact stresses the idea of a “story” through a great curved display case that is suspended through the vaults of space. Moreover, a multimedia sector has recently been inaugurated. The area envisages strong interaction with the public and illustrates the history of plastic beginning with early chemical experiments and all the way to bioplastics, using recreational methods that are also suitable for children. In setting up the exhibition, the Plart Foundation has done its best to surprise visitors and play with the emotions that plastics, generally considered a poor and polluting material, may generate on the contrary, with the aim of conveying the principle according to which the conscientious use of materials, and polymers in particular, is necessary and possible – thus making the best use of their performance characteristics while safeguarding the environment. The Plart Foundation has done all of this through an innovative staging and the careful selection of items to be showcased.



The Plart Foundation. The exhibition structure of the permanent collection



The Plart Foundation. The room of Celluloid



The Plart Foundation. The exhibition of Sonia Biacchi



The Plart Foundation. The exhibition of Wanda Romano



The Plart Foundation. The exhibition of Alessandro Ciffo

## Reference list

1. AA.VV., *Plastico, formas e colores dos materiais sinteticas*, Fundaçào Armando Alvares Penteado, Museo de Arte Brasileira - MAB, 18 de Maio a 7 de Julho de 2002 Colecào Maria Pia Incutti, Napoli.
2. A. Baldini, L.P.Puglisi, *PresS/Tmag, Mancosu Architectural book*, Roma 2009 pp. 294-295.
3. F. Bulegato, "Un contributo alla diffusione della 'cultura plastica': gli allestimenti dei fratelli Castiglioni per Montecatini" in C. Cecchini (a cura di), *Mo... Moplen. Il design delle plastiche negli anni del boom*, Rdesignpress, Roma 2006.
4. C. Cecchini, "Allestire con le plastiche per mostrare le plastiche: una nobile tradizione" in G. Donini (a cura di) *L'architettura degli allestimenti*, Kappa, Roma 2010.
5. A. Tecce (a cura di), *In plastica, forme e colori dei materiali sintetici*, Electa Napoli, Catalogo mostra Museo Pignatelli 8 giugno-16 settembre, 1990.

**Innovative School-level  
Quantitative Chemistry Experimental Technique (I)  
*pH Measurement by Antimony Electrode***

**K. M. CHAN**

*Director, MicroChem Lab, Hong Kong SAR of China  
E-mail: mclchan@biznetvigator.com Tel: (852)-94751148*

**Abstract**

*The paper advocates the use of “DMM display” technique in which a single piece of instrument (DMM) is used as a terminal display for more than one type of experiments.*

*The “DMM display” technique employs commercial low-cost digital multimeter (DMM) to act as a common display instrument for quantitative measurements of (i) pH (ii) solution conductance and (iii) colour intensity of aqueous solutions. Principle of measurement is based on probes for these reactions output d.c. electrical signals which can be nicely handled by the high-input resistance of such kind of DMM involving voltage (e.m.f.) measurements.*

*The paper introduces principles of pH measurement by antimony combination electrodes, use of innovative mini “salt-plug” and details for the construction of the electrodes and an electronic sensor. Description includes **Model A**, the direct-reading model using the electrodes, the sensor and a DMM which displays amplified cell e.m.f. according to a pre-set condition of 10 mV per pH, and **Model B**, the basic model, using electrodes and DMM alone.*

*The “DMM display” technique works for measurements of conductance and colour intensity as well as pH, provided that suitable sensors are used.*

**Keywords:** pH measurement, voltage amplification by Op Amp, salt bridge of chemical cells, linear regression

**Introduction**

Quantitative measurement of pH of aqueous solution is essentially the measurement of change in e.m.f. of a chemical cell formed by electrodes immersed in the solution. Today, most commercial pH meters employ the use of H<sup>+</sup>(aq) ion sensitive glass membrane electrode coupled with a silver/silver chloride reference electrode. However, fabrication of glass electrode is costly and schools with resource constrain cannot afford multiple sets of pH meter for student use, needless to say glass electrodes have limited lifetime and vulnerable to breakage. In fact, it had been shown, at the beginning of last century [1], that antimony metal in aqueous solution as a half-cell electrode also generates e.m.f. which depends on the concentration of H<sup>+</sup>(aq) ions in solution. This offers another means of quantitative measurement of pH [2]. Recently, antimony electrode was re-discovered as surgical equipment for pH measurement, primarily because of its ability to be miniaturized [3].

**School-level pH measurement: Antimony electrode vs Glass electrode**

Mechanism of glass-membrane hydrogen ion sensitive electrode has been well documented. On the other hand, antimony electrode, because of its drawbacks, was not adopted for advanced scientific measurements. We have no up-dated information on the mechanism of dependence of half-cell e.m.f. of antimony electrode on hydrogen ion concentration. However, judging from the pH range most school-based quantitative experiments encounter and considering users’ instrumental competence, accuracy of pH measurement by antimony electrode should not be a major problem.

**Antimony electrode**

From standard electrode potential literature, we have the following [4]:

(A) With reference to standard hydrogen electrode ( $E^\phi = 0.000$  V, **Table 1**)

**Table 1.**  $E^\phi$  value of Sb(III) in alkaline, neutral and acidic media

Medium	Reduction half equation	$E^\phi$ /V
Alkaline	$\text{SbO}_2^- (\text{aq}) + 2\text{H}_2\text{O}(\text{aq}) + 3\text{e}^- \rightleftharpoons \text{Sb}(\text{s}) + 4\text{OH}^-(\text{aq})$	-0.639
Neutral or slightly acidic	$\text{Sb}_2\text{O}_3(\text{s}) + 6\text{H}^+(\text{aq}) + 6\text{e}^- \rightleftharpoons 2\text{Sb}(\text{s}) + 3\text{H}_2\text{O}(\text{l})$	+0.150
Acidic	$\text{SbO}^+(\text{aq}) + 2\text{H}^+(\text{aq}) + 3\text{e}^- \rightleftharpoons \text{Sb}(\text{s}) + \text{H}_2\text{O}(\text{l})$	+0.204

Clearly, according to the Nernst equation, half-cell formed by antimony oxidation state (III) species  $\text{SbO}_2^-$ ,  $\text{Sb}_2\text{O}_3$  and  $\text{SbO}^+$  involves  $\text{H}^+(\text{aq})$  or  $\text{OH}^-(\text{aq})$  and generates e.m.f. which depends on concentration of  $\text{H}^+(\text{aq})$  covering the entire pH range.

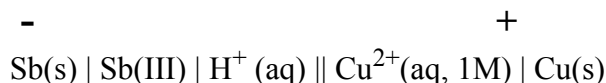
In most cases, commercial reference electrode for full cell pH measurement is the  $\text{Ag}/\text{Ag}^+(\text{aq})$  reference electrode. For the experiment, we use a less expensive alternative which is a low-cost  $\text{Cu}/\text{Cu}^{2+}(\text{aq})$  half-cell.

(B) With reference to standard copper/copper(II) ion electrode ( $E^\phi = +0.340$  V, **Table 2**)

**Table 2.**  $E^\phi$  value of Sb(III) w.r.t.  $\text{Cu}/\text{Cu}(\text{II})$  electrode potential in alkaline, neutral and acidic media

Medium	$E^\phi$ /V, w.r.t. standard hydrogen electrode	$E^\phi$ /V, w.r.t. standard $\text{Cu}/\text{Cu}^{2+}$ standard electrode
Alkaline	-0.639	$-(+0.340 + 0.639) = -0.979$
Neutral or slightly acidic	+0.150	$-(+0.340 - 0.150) = -0.190$
Acidic	+0.204	$-(+0.340 - 0.204) = -0.136$

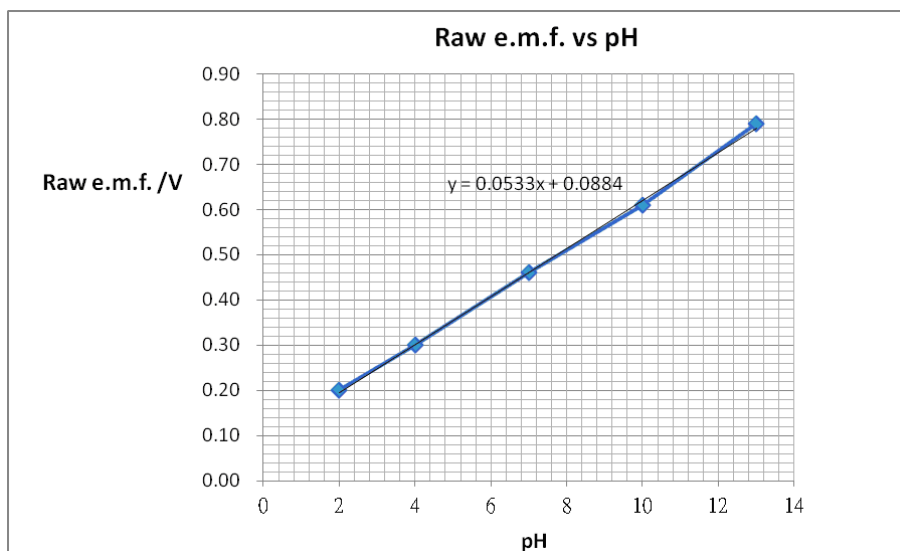
Chemical cell formed during pH measurement:



Theoretically, a chemical cell formed by  $\text{Sb}/\text{Sb}(\text{III})$  half-cell and a  $\text{Cu}/\text{Cu}(\text{II})$  reference half-cell will generate a potential difference covering the most commonly encountered pH range of 1 to 13, with Cu as the positive pole, from 0.136 V to 0.979 V.

The actual e.m.f.s. measured by a low-cost commercial DMM, with a usual input resistance of 10  $\text{M}\Omega$  only, do not agree with the theoretical expectation, but are still very close, as shown by the following graph (**Graph 1**):





**Graph 1.** Raw e.m.f. of Sb/Cu chemical cell vs pH

The good thing about the result is that (i) a linear relationship between e.m.f. and pH is observed, (ii) internal resistance of the cell formed is low which favours easy e.m.f. measurement and hence (iii) e.m.f. output is stable.

### **Glass electrode**

For glass electrode, as revealed by most literature, a true linear relationship is found between e.m.f. and pH over practically the entire pH range, notably from pH 0 to 12 (except the acid and alkaline error ranges at the two extremes) [5]. Also, glass is resistant to corrosion by most chemicals. However, cell formed by glass membrane electrode has extremely high internal resistance, typically in the order of  $10^{10} \Omega$ . Although chips of nowadays are capable of handling very high input impedance, this still causes problem in obtaining stable and reproducible readings, as the instrument is vulnerable to “noise” interference.

### **Summary**

<b>Antimony electrode</b>	<b>Glass electrode</b>
<ul style="list-style-type: none"> <li>* Almost linear relationship between cell emf and pH, from pH 2 to 12</li> <li>* Low cell internal resistance. Conventional plug and socket input are suffice.</li> <li>* Slower response, less sensitive to low pH ranges</li> <li>* Readings reproducible and stable</li> <li>* Measurement principle explained at school level</li> <li>* Sturdy</li> <li>* Lifetime dependent on mass of electrode</li> <li>* Liable to chemical corrosion</li> <li>* Easy fabrication</li> <li>* Low-cost</li> </ul>	<ul style="list-style-type: none"> <li>* True linear relationship between cell emf and pH, from pH 0 to 12, except the acid and the alkaline error ranges</li> <li>* Extremely high cell internal resistance. BNC plug and socket input are required</li> <li>* Faster response, sensitive to all regions of the linear pH range.</li> <li>* Today's high-tech high impedance input fabrication enables reproducible and stable readings, but still liable to external interference</li> <li>* Advanced measurement principle</li> <li>* Fragile</li> <li>* Limited glass membrane lifetime</li> <li>* Resistant to chemical corrosion</li> <li>* High-tech fabrication needed</li> <li>* Expensive</li> </ul>

Examination of the advantages and disadvantages between antimony and glass electrodes reveals that antimony electrode is a better choice than glass electrode for school use.

### Innovative “Salt-plug”

A small piece of freshly prepared filter paper strip wetted with sat.  $\text{KNO}_3$  solution is usually employed as a salt bridge for school use. In the experiment, an alternative way is used which involves a small section of wooden toothpick soaked with sat.  $\text{KNO}_3$  solution and let dried. A number of such small pieces of home-made instrument are readily available as innovative “salt-plugs”. Using them is very simple: First fill the reference electrode glass tubing compartment with 1M  $\text{CuSO}_4$  solution, and then insert the “salt-plug” into the opening of the glass tubing. Air bubbles in the compartment are not allowed as they may cause the copper metal and the copper(II) sulfate solution out of contact (**Figures 1, 2, 3 and 4**). Lower the finished reference electrode, together with the antimony electrode, into the testing solution for pH measurement.

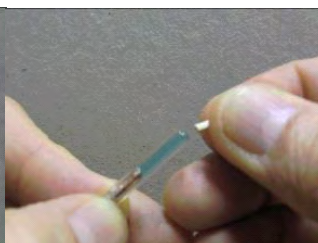
“Salt-bridges” need to be freshly prepared for each measurement. However “salt-plugs”, after rinsing, can be used repeatedly until the end of the experiment.



**Figure (1)**  
Use a micro-tip plastic pipette to fill the small compartment with 1M  $\text{CuSO}_4$  solution



**Figure (2)**  
Solution should be filled to the top of the small tubing. Slight excess as judged by an almost overflow.



**Figure (3)**  
Insert the “salt plug”



**Figure (4)**  
Prepared copper /copper sulfate electrode with no air bubbles

## Practical pH measurement by antimony electrode

### (A) Direct-reading model

#### Theory of measurement

The “DMM Display” technique requires change in e.m.f. of cell proportional to pH variation. For example, if the testing solution has a pH of 4, the antimony/copper cell and sensor combination should output a voltage of 40mV, 70 mV for pH 7, 100 mV for pH 10 etc. In this way, voltage readings can be interpreted as pH readings, with self-determined decimal places.

Although raw cell e.m.f.vs pH as shown by **Graph (1)** is a straight line, it does not pass through the origin and hence raw e.m.f. is not directly proportional to pH. The graph shows an OY axis intercept of 0.0884 V, and subtraction of this value of voltage from each raw e.m.f. reading will bring the adjusted e.m.f. exactly proportional to pH. That is to say, the raw e.m.f. vs pH straight line will be converted to one which passes the origin and achieves a 0 pH (in) / 0 volt (out) condition. Even if this has been done, each adjusted reading still has to be amplified by a fixed voltage gain (“one-point” calibration, **Table (4)** and **Graph (3)**) so as to achieve the desired display of *10 mV per pH* e.g. 35 mV for pH 3.5; 66 mV for pH 6.6 etc.

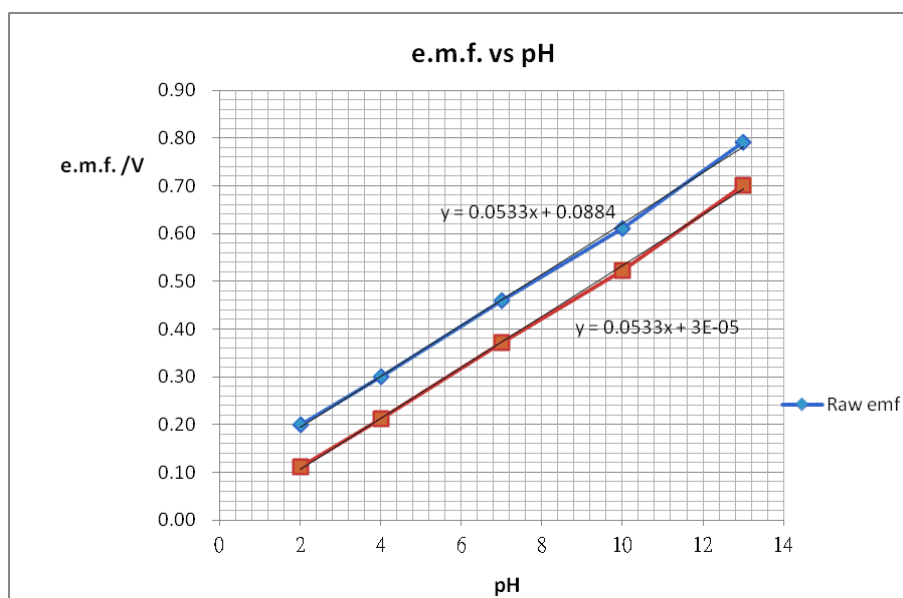
Voltage gain is calculated as follows (referring to **Graph (1)**):

Consider pH 7.00: Adjusted voltage =  $(0.46 - 0.0884) \text{ V} = 0.3716\text{V}$ . This value of voltage has to be amplified to 0.700V. Voltage gain =  $0.700/0.3716 = 1.8837$

An electronic device (sensor) is needed to do both jobs, i.e. (i) raw e.m.f. subtraction and (ii) voltage amplification. Circuit of the sensor will be described in detail later. Treatment of raw cell e.m.f. so far can be summarized as follows:

**Table 3.** Generated values of adjusted e.m.f.

pH	Raw e.m.f./V	Adjusted e.m.f./V
2	0.20	$(0.20 - 0.0884) = 0.1116$
4	0.30	$(0.30 - 0.0884) = 0.2116$
7	0.46	$(0.46 - 0.0884) = 0.3716$
10	0.61	$(0.61 - 0.0884) = 0.5216$
13	0.79	$(0.79 - 0.0884) = 0.7016$

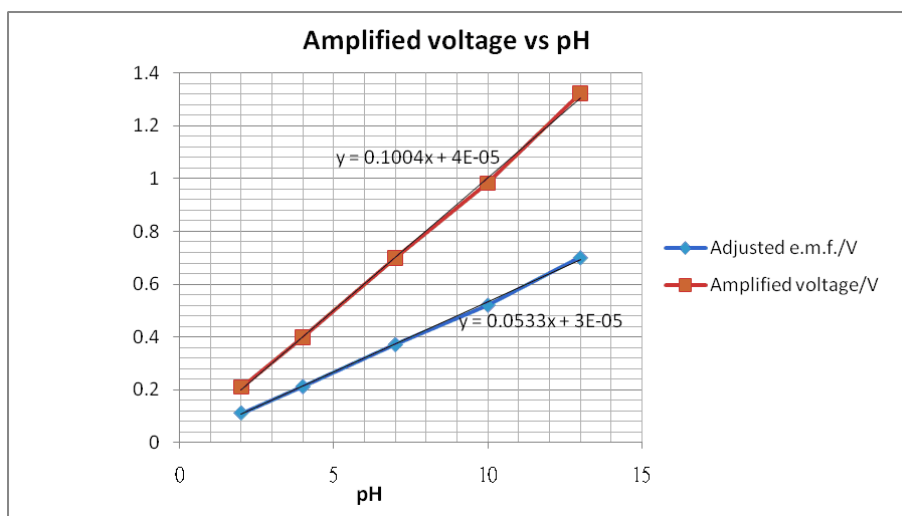


**Graph 2.** Adjusted e.m.f. vs pH

**Table 4.** “One-point calibration” and interpretation of final display

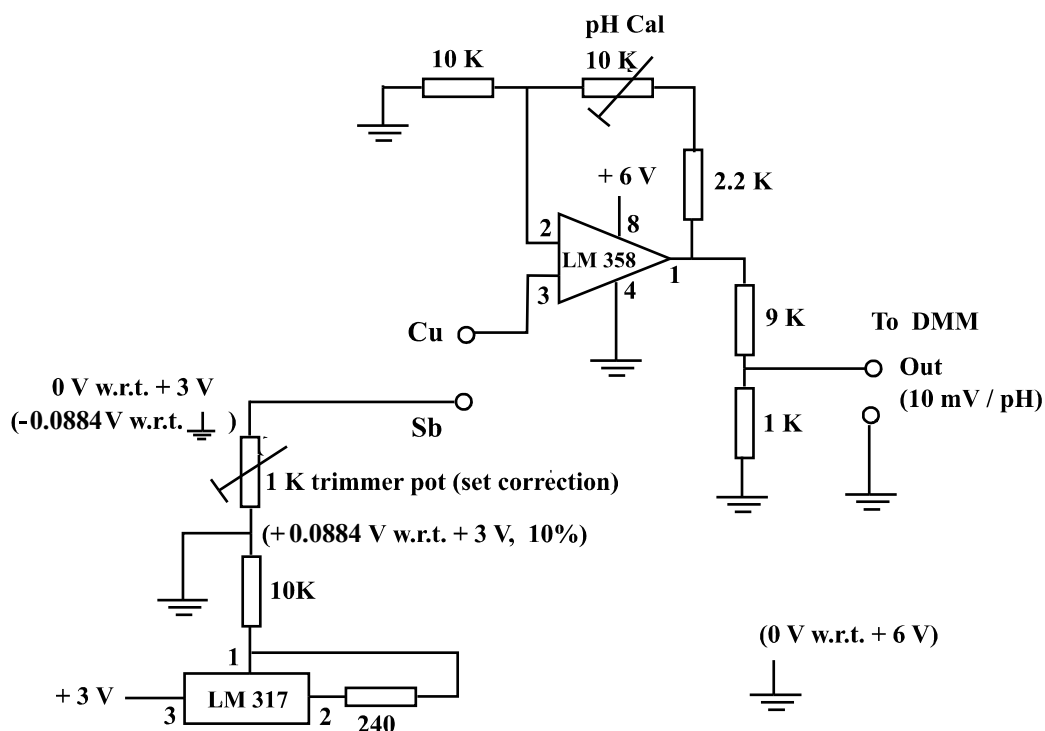
pH	Adjusted e.m.f./V	“One-point” calibration	Amplification ratio	Amplified voltage/V	Attenuated (output) voltage/mV	Interpreted pH
2	0.1116	---	---	$(0.1116 \times 1.8837) = 0.2102$	21	2.1
4	0.2116	---	---	$(0.2116 \times 1.8837) = 0.3986$	40	4.0
7	0.3716	0.700V	$\frac{0.700}{0.3716} = 1.8837$	$(0.3716 \times 1.8837) = 0.700$	70	7.0
10	0.5216	---	---	$(0.5216 \times 1.8837) = 0.9827$	98	9.8
13	0.7016	---	---	$(0.7016 \times 1.8837) = 1.3216$	132	13.2

Buffer solutions of 2, 4, 7, 10 and 13 are used for calibration. A 0.100 M NaOH solution can be regarded as a pH 13 buffer solution.



Graph 3. Adjusted and amplified e.m.f.s

### Sensor circuit and description



$$(\text{Measured cell e.m.f.} = \text{Raw emf} - 0.0884 \text{ V})$$

Figure 5. Sensor circuit

#### (i) Power supply

The sensor circuit (**Figure 5**) employs two power supplies. One (3V) for the adjustable voltage regulator LM 317 [6] to generate a negative voltage reference, and the other (6V) for the  $V_{cc}$  of Op Amp LM 358

[7]. They are readily supplied by using three button-type 3V lithium batteries, two of which are connected in series to obtain 6V. Adjustable voltage regulator LM 317 is used because the chip can handle low input voltages (i.e. 3V). Linear dual Op Amp LM 358 is chosen for the amplification stage because this IC needs only single power supply (i.e. it does not need a negative power supply).

**(ii) Negative voltage reference and input e.m.f. correction**

Adjustable voltage regulator LM 317 is connected by peripheral resistors to output a regulated voltage. By adjusting the  $1\text{K}\Omega$  trimmer pot (15 turn compact variable resistor), a stable voltage reference of  $+0.0884\text{V}$  can be obtained. This positive voltage reference source is then connected to the ground of the power supply (6V) of Op Amp LM 358. In this way, the separate ground terminal (3V) which generates the reference voltage becomes  $-0.0884\text{V}$ . The procedure can be described as “set correction” because by applying this negative voltage, raw e.m.f.s are “set” and “corrected” for direct proportionality. LM 317 is not a formal voltage reference chip but it can offer stable voltage output over a period of time. Availability and low cost are the reasons for adopting it. Slight drift of p.d. on prolong usage is expected especially when the chemical cell has a low internal resistance and it is advisable to adjust “set correction” back to  $-0.0884\text{V}$  after each 5 experiments

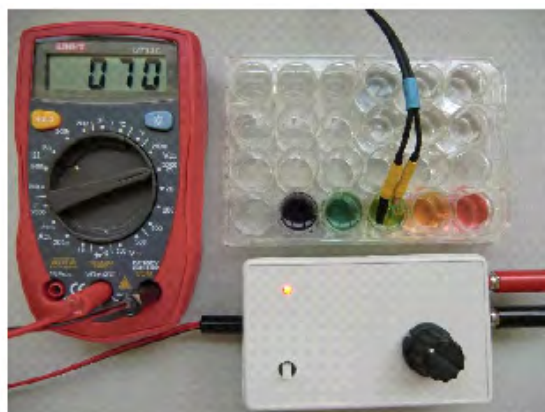
Pin 3 of LM 358 (non-inverting input) is connected to the positive pole (Cu) of the Sb/Cu chemical cell used for pH measurement. The negative pole (Sb) is connected to the  $-0.0884\text{V}$  reference voltage source. This results in summing the two voltages [8], i.e.  $E_{\text{cell}}$  and  $-0.0884\text{V}$ . The adjusted e.m.f. of the Sb/Cu chemical cell becomes  $(E_{\text{cell}} - 0.0884)\text{V}$ . Theoretically, the adjusted e.m.f. straight line graph should pass through the origin.

**(iii) Amplification of adjusted e.m.f. and “one-point” calibration**

Adjusted e.m.f. is fed to the non-inverting input (pin 3) of LM 358. A resistor network between pin 2 and pin 1 amplifies it by a ratio gain which is controlled by adjusting the variable  $10\text{K}\Omega$  resistor

Immerse the antimony combination electrodes in a pH 7 buffer solution. Turn the knob of the variable resistor, i.e. adjust the  $10\text{K}\Omega$  variable resistor, until a voltage of 70 mV is displayed. A display of 70 mV is interpreted as a value of pH 7.0. In this way, voltage output of the sensor is literally directly proportional to pH. The position of the knob is then fixed and the sensor is said to be calibrated – “One-point” calibration (**Table (4)** and **Figure (6)**).

*An attenuating resistor ladder (9: 1) at pin 1(output) of LM 358 limits the output in the millivolt range such that 70mV is registered in the DMM instead of 700 mV. An attenuation ratio of 10: 1 is chosen because a display of 70 mV has to be interpreted as a pH value of 7.0. While the voltage can be displayed as 700 mV without attenuation, circuit design itself does not warrant an accurate interpretation of a pH value of 7.00. Overall result is an output of 10 mV per pH.*



**Figure (6)** “One-point” calibration

Measurement error is controlled by (i) linearity of pH response of antimony electrode, (ii) accuracy of the adjusted e.m.f., (iii) amplification ratio and (iv) accuracy of the pH value of buffer solutions. Judging from school level usage, measurement error caused by using the sensor is acceptable.

**(iv) A completed homemade sensor**

Using available electronic components, circuit as shown in **Figure 5** can be soldered onto a semi PCB (**Figures 7 and 8**). The completed body can be housed in a plastic utility box measuring 10 cm x 6 cm x 2.5 cm (**Figures 9 and 10**)



**Figure (7)**  
Electronic components soldered onto a semi PCB



**Figure (8)**  
Exposed interior of utility box (three 3V lithium button-type batteries are labeled as 1, 2 and 3)



**Figure (9)**  
Finished utility box with all components installed



**Figure (10)**  
Small side opening for adjusting set correction  
1K  $\Omega$  trimmer pot

**Fabrication of antimony electrode and copper/copper sulfate reference electrode**

**(1) Antimony electrode**

Antimony metal of A.R. grade was strongly heated in a crucible (inside a fume cupboard) until it melted (**Figure 11**). The molten metal was withdrawn upward, with the help of a pipette filler or syringe, into a small glass tube. The hot liquid antimony solidified inside the glass tube and the solid metallic rod was taken out by breaking the glass tube.



**Figure (11)**  
Melting antimony metal in a crucible



**Figure (12)**  
Fabricated electrode

A small piece of the prepared antimony rod was soldered onto a copper lead for electrical contact. The metal/copper rod combination was sealed by a section of heat-shrinkable plastic tubing to form a formal pH electrode (**Figure 12**)

**(2) Copper/copper(II) sulfate reference electrode**

The copper/copper(II) sulfate reference electrode (**Figure 13**) is constructed by using a short section of glass tube, one end of which is sealed (epoxy cement) with a protruded thick copper wire, leaving a small compartment for filling copper(II) sulfate solution. A small "salt-plug" replaces a conventional filter paper salt bridge. A "salt-plug" is a small section of wooden toothpick soaked in sat  $\text{KNO}_3$  solution and allowed to dry. Air bubbles are not allowed in the compartment, otherwise solution conductance will be increased (**Figure 14**)



**Figure (13)**  
Copper electrode and "salt-plug"



**Figure (14)**  
Finished Cu/Cu(II) reference electrode

### (3) Completed combination electrodes



**Figure (15)** Finished Sb and Cu/CuSO<sub>4</sub> electrodes

#### (B) Basic model

##### Theory of measurement

The sensor is an electronic device for converting raw e.m.f.s to desired output voltages for the sake of convenience and can be done without it. By plotting a calibration graph of raw e.m.f. against pH, unknown pH can be deduced from the raw e.m.f. alone. This is best done by computer software involving linear equation regression.

Details of the method will be illustrated in the suggested experiment “Measurement of solution pH”

#### Suggested Experiments

##### Expt. 1 Measurement of solution pH (Basic model)

###### (A) Calibration of antimony pH meter

###### Procedure

1. Prepare a copper/copper(II) sulfate reference electrode as follows:  
Place drops of 1M CuSO<sub>4</sub>(aq) into the small compartment of the glass tubing section of the electrode by using a micro plastic pipette. Firmly close the end with a “salt plug”, ensuring *no air bubble* is included (**Figures 1, 2, 3 and 4**). *Leakage of CuSO<sub>4</sub> solution can ruin measurement* and this can be checked by noting if the aqueous solution, in the absence of pH indicators, would become blue. However, slight leakage for conductance has to be allowed.
2. Clean the antimony electrode with sand paper
3. Place buffer solutions of pH 2, 4, 7, 10 and 13 (simply a 0.100M NaOH solution) separately into 5 wells of a 24-well plate. Add 3 drops of universal indicator solutions to each of the buffer solutions.
4. Connect the copper/copper(II) sulfate reference electrode to the positive terminal and the antimony electrode to the negative terminal of a DMM. Lower the two electrodes into the well containing the pH 2 buffer solution.
5. It was reported that oxygen of air participated in the half-cell reaction of antimony [9]. Hence *constant stirring* of the electrode is necessary.
6. Allow 1 minute for electrical equilibrium. Record the e.m.f. developed (**Figure 16**). Antimony electrode is less sensitive to low pH values. Repeated experiment is necessary if results are found not acceptable (expected e.m.f. around 0.20V).



**Figure (16)** Raw e.m.f. in pH 2 buffer



**Figure (17)** Raw e.m.f. in pH 4 buffer



**Figure (18)** Raw e.m.f. in pH 7 buffer



**Figure (19)** Raw e.m.f. in pH 10 buffer



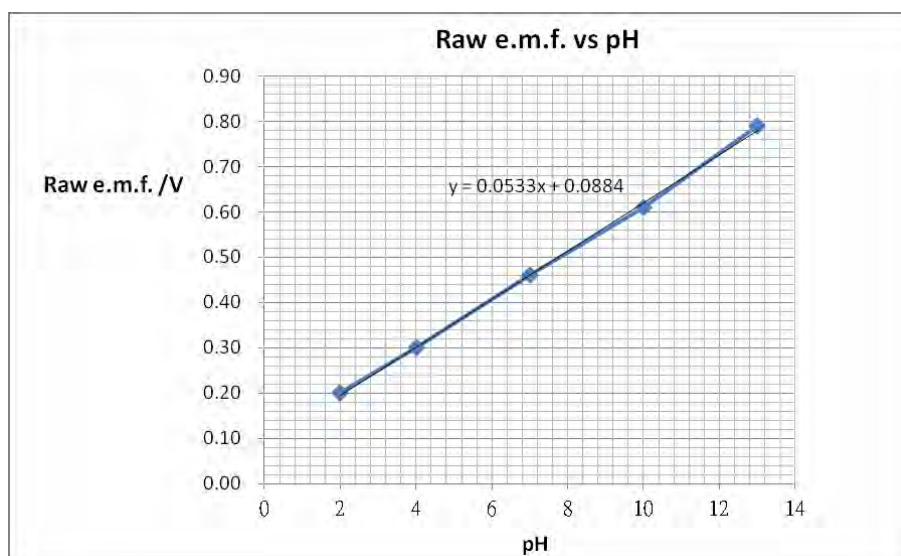
**Figure (20)** Raw e.m.f. in pH 13 buffer

7. Repeat the experiment with buffer solutions of pH 4, 7, 10 and 13. Record the e.m.f. developed each time (**Figures 17, 18, 19 and 20**).
8. Organize a table with pH and e.m.f. values as columns. Activate a suitable spreadsheet (e.g. Microsoft Excel) and plot a graph of e.m.f. vs pH.

## Results

pH	2	4	7	10	13
e.m.f. of Sb/Cu couple / V	0.20	0.30	0.46	0.61	0.79

*Note: Voltage readings of stationary or moving antimony electrode do not agree. Antimony electrode should be kept moving while making measurements*



**Graph 4.** Hand-plotted graph of raw e.m.f. vs pH



**Correlation linear equation:  $y = 0.0533x + 0.0884$**   
**Calibration equation: e.m.f. = (0.0533)pH + 0.0884**

**(B) pH measurement**

**(1) pH deduction from calibration st. line graph**

The calibration straight line graph (**Graph 4**) can be extrapolated to cover the entire pH range of 1-14. It enables the antimony combination electrodes to read pH of aqueous solutions. For example, by dipping the electrodes into an aqueous solution of unknown pH and if the measured e.m.f. is, say, 0.70V, then by dropping a perpendicular line, this value of e.m.f. would imply the pH of the solution is 11.7. Alternatively, one can also use the calibration equation:

$$0.70 = (0.0533)(\text{pH}) + 0.0884 \text{ or } \text{pH} = 11.47$$

**(2) pH deduction from computer software involving linear regression**

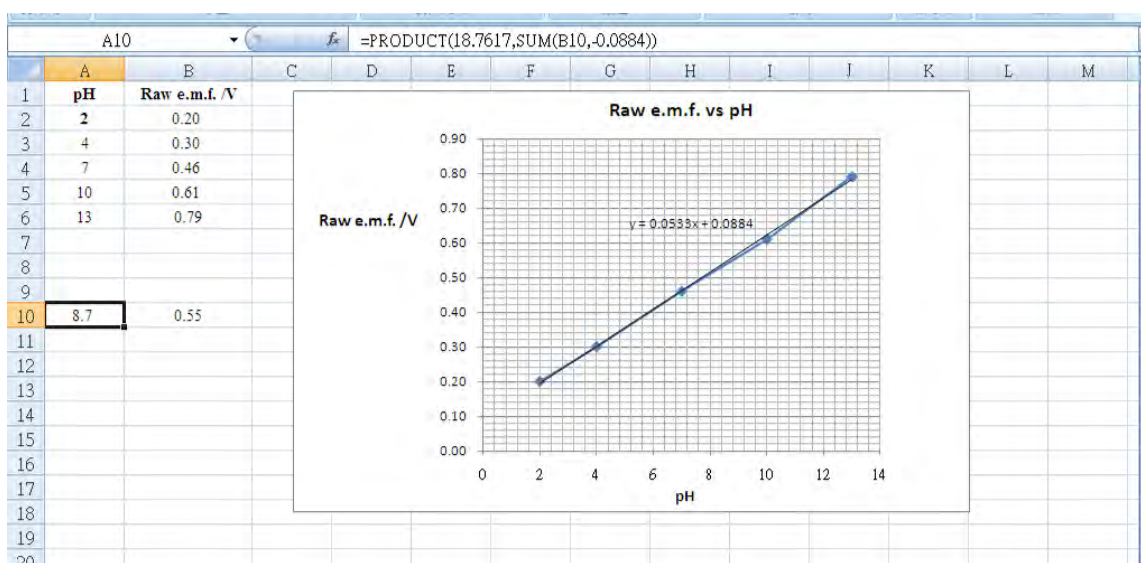
Apart from the first-principle approach based on deduction of pH from a plotted straight line calibration graph, it is more convenient to convert raw e.m.f. into pH values directly by using the spreadsheet software "Excel".

Linear equation from the e.m.f. vs pH straight line calibration graph

- a. Activate the Microsoft "Excel" spreadsheet software
- b. Input reading of pH and e.m.f. values
- c. Select the Graph Wizard icon and the X-Y scattered plot option
- d. Click spots of the displayed straight line graph of e.m.f. vs pH and obtain the derived linear equation using the Trendline function

pH from linear equation by inputting e.m.f. readings and using "Excel" commands

- a. Prepare a table of number of drops of 0.1M NaOH solution and corresponding e.m.f. readings
- b. Create a column for pH values
- c. Based on the derived linear equation  $y = 0.0533x + 0.0884$ , where  $x$  and  $y$  represent pH and e.m.f. values respectively, input commands for the conversion equation: `=PRODUCT(18.7617,SUM(e.m.f.,-0.0844))` where 18.7617 is 1/slope or 1/0.0533
- d. Drag the lower right corner of the pH value cell and obtain all pH values corresponding to each of the e.m.f. values
- e. pH of the testing solution can be easily obtained by inputting the measured raw e.m.f. to one of the cells under the e.m.f. column. For example, an input of 0.55V will receive an immediate display of pH 8.7 (**Figure 21**).



**Figure (21)** One-line "Excel" command program based on the calibration straight line graph

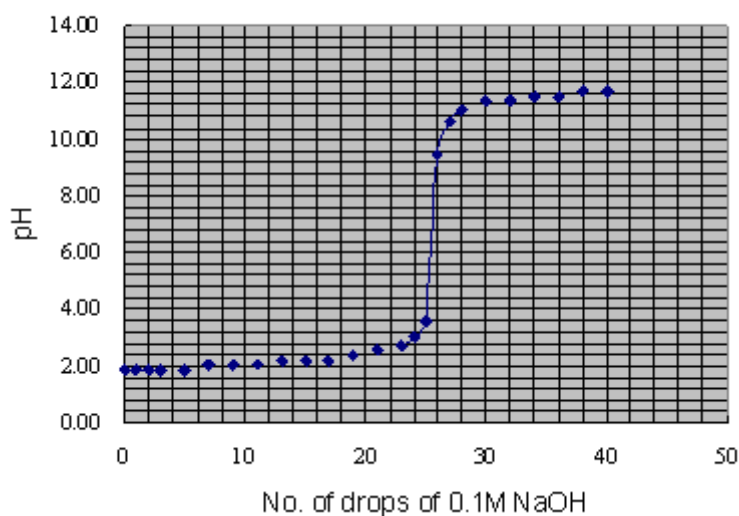
**Expt. 2 pH Titrations (Direct-reading model)****(I) Strong acid vs strong alkalis (0.1M HCl vs 0.1M NaOH)****Procedure**

1. Prepare an antimony electrode and a copper/copper(II) sulfate reference electrode as described in Expt 1 steps 1 and 2.
2. With the help of a Pasteur pipette, add 25 drops of 0.1M HCl solution to a well of a 24-well plate, followed by 1 drop of phenolphthalein indicator.
3. Connect the copper/copper(II) sulfate reference electrode and the antimony electrode to the sensor. Output of the sensor is connected to a DMM, with the voltage range set at 2000 mV full scale. Lower the two electrodes into the well containing the prepared HCl solution.
4. Keep the reference electrode stationary and *move the antimony electrode to and fro to keep it in constant motion.*
5. Allow 1minute for electrical equilibrium. Record the pH developed.
6. Thoroughly cleanse the *same* Pasteur pipette and use it to transfer 0.1M NaOH solution, drop by drop, to the well. Record pH readings when the DMM displays are steady. Observe for signs of development of colour in the solution.
7. Continue the drop-wise titration until 40 drops of 0.1 M NaOH solution have been added.

**Data****Table (5) NaOH vs HCl micro-scale titration data**

No. of drops of 0.1 M NaOH	pH	No. of drops of 0.1 M NaOH	pH
0	1.45	21	2.16
1	1.45		
2	1.45	23	2.34
3	1.45	24	2.70
		25	3.23
5	1.45	26	9.31
		27	10.56
7	1.63	28	10.91
9	1.63	30	11.27
11	1.63	32	11.27
13	1.80	34	11.45
15	1.80	36	11.45
17	1.80	38	11.63
19	1.98	40	11.63

pH vs No. of drops of 0.1M NaOH



Graph (5) pH titration curve for NaOH vs HCl

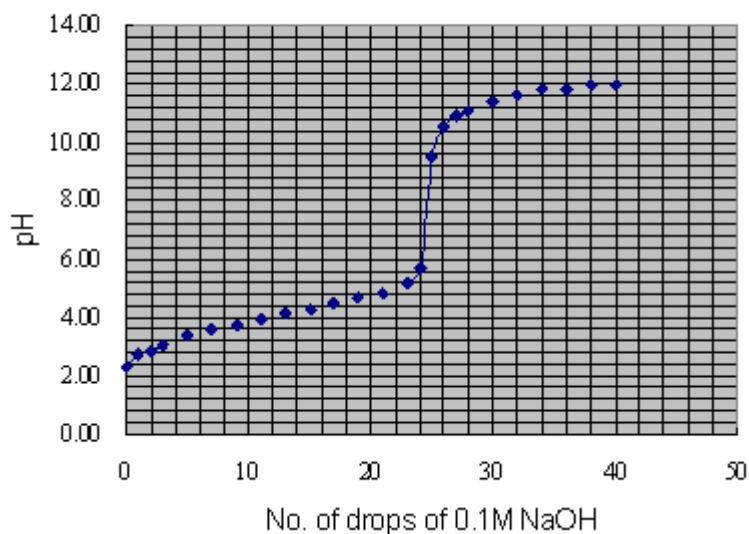
**(II) Weak acid vs strong alkalis (0.1M CH<sub>3</sub>COOH vs 0.1M NaOH)****Procedure**

Repeat the experiment as described in Part (I), replacing 0.1M HCl solution by 0.1M CH<sub>3</sub>COOH solution.

**Data**Table (6) NaOH vs CH<sub>3</sub>COOH micro-scale titration data

No. of drops of 0.1 M NaOH	pH	No. of drops of 0.1 M NaOH	pH
0	2.34	21	4.84
1	2.70		
2	2.88	23	5.20
3	3.05	24	5.73
		25	9.48
5	3.41	26	10.56
		27	10.91
7	3.59	28	11.09
9	3.77	30	11.45
11	3.95	32	11.63
13	4.13	34	11.81
15	4.30	36	11.81
		37	
17	4.48	38	11.98
19	4.66	40	11.98

## pH vs No. of drops of 0.1M NaOH

Graph (6) pH titration curve for NaOH vs CH<sub>3</sub>COOH

### Conclusion

Antimony metal in aqueous solution forms a half-cell whose e.m.f. varies linearly with pH over a commonly used range. A Cu/Cu(II) reference half-cell is used for pH measurement. The reference half-cell is fabricated by incorporating an innovative “salt-plug”. A commercial low cost digital multimeter is used for cell e.m.f. measurement. Digital display of pH is achieved by (i) calibration with a linearly plot or (ii) using a self-devised electronic sensor which outputs amplified analogue voltages according to a preset condition of 10mV per pH.

### Reference

1. Uhl, A. and W. Kestaneck, *Monatsh. Chem*, 1923, **44**, 29
2. K.M. Chan, *Homemade equipment for the teaching of electrochemistry at advanced level (Part II)* The School Science Review, March 1985 pp 455-466, published by The Association for Science Education, U.K.
3. Opekun, Smith and Graham, *Antimony electrodes. Mucosal potential differences and buffer composition adversely affect pH measurements in the stomach. Dig Dis Sci*, 1990 Aug; 35(8): 950-5.
4. G. Milazzo, S. Caroli, and V. K. Sharma, *Tables of Standard Electrode Potentials*, Wiley, Chichester, 1978.
5. K.L. Cheng and Da-Ming Zhu, *On Calibration of pH Meters*, Dept of Chemistry, University of Missouri-Kansas, 27 April 2005
6. *Linear and Interface Integrated Circuits*, Published by Motorola Inc., 1990 p. 3-21
7. *Linear and Interface Integrated Circuits*, Published by Motorola Inc., 1990 p. 2-76
8. Harry W. Fox, *Master Op-Amp applications handbook*, 1978, TAB Books p. 97
9. Gatty.O and ECR Spooner, *The Electrode Potential Behaviour of Corroding Metals in Aqueous Solutions*, Oxford University Press, London and New York, 1938, p. 331

## Cross-curricular Educational tools dedicated to water resource policy problems

Marcin M. CHRZANOWSKI<sup>1,2</sup>, Irmína BUCZEK<sup>1</sup>, Barbara OSTROWSKA<sup>1</sup>

<sup>1</sup> Science Section, Educational Research Institute, Warsaw, Poland

<sup>2</sup> Institute of Physics, Military University of Technology, Warsaw, Poland

m.chrzanowski@ibe.edu.pl

### Abstract

*One of the essential goals of the Educational Research Institute Science Section is to provide teachers with didactical inspiration, novel solutions and ready-for-use educational tools. The main role of those tools, which are anchored in the new Polish Science Curriculum, is to show Polish teachers how to evaluate students' thinking skills. In the present paper may be found a cross-curricular set of tools dedicated to teaching about water resource policy problems with their characteristics and some tips on how to introduce them during classes and on what kind of problems may occur during their use. This set was prepared to synthesize and broaden students' knowledge as stipulated in different sections of Polish Chemistry Curriculum for ISCED2 level and deepen their understanding of water resource problems.*

**Keywords:** reasoning skills, educational tool, school curriculum, water resource problems, curriculum, multiple choice question.

### 1. Passionate about Education project

From April 2009 up to July 2015, the Educational Research Institute is implementing a project *Teaching quality and school effectiveness – building tools for research – Passionate about Education*. The main aim of the project is to strengthen the evidence-based approach to forming educational policies and practice. This is about creating the conditions needed for making decisions based on statistics and research results. The principles of this apply to all levels of the education system and therefore they refer to both the schools and the student-teacher relationship [1]. The main scopes of the project are, amongst others: interdisciplinary research, monitoring research in Poland and in other countries, reports on the state of education in Poland and providing teachers and students with free of charge teaching aids and inspirations: queries, exercises, lesson ideas and descriptions of good practice.

### 2. Educational tools dedicated to water resource problems

The authors of the present paper would like to present an exemplary set of cross-curricular tools (together with detailed comments) which may be used as a theme for carrying out a lesson at the end of the education cycle at ISCED2 level. One of the *learning outcomes* of the new Polish science curriculum for chemistry (ISCED2 level) states that *The student should be able to give the propositions for reasonable water resources management* [2]. The authors suggest that this set be used before final external exams, once all of the *general aims* and *learning outcomes* have been accomplished and the students have gained the knowledge specified for this stage of education. The skills involved in this kind of repetition are: recalling, recognition, defragmentation, transforming and establishing new connections between fragmented pieces of information and making use of acquired skills in a new for students, untypical situation. On the one hand such a situation ensures that a student has to solve the problems on his or her own – and not only recall some specific information to their mind. On the other hand this way of repeating information is also good and useful for teachers, since it makes them able to discuss a subject or a problem in a novel way relying on the knowledge acquired by the students, emphasizing its cross-sectional usage.

The tools presented may be used to assess students' knowledge in such fields as: changes in states of matter in company with factors influencing this phenomena (temperature, insolation, pressure, *et cetera*), classification of inorganic substances and ion dissociation. In all of the exercises different multiple choice question (MCQ) are found. They vary in format and in content (as in final exams at ISCED2 level in Poland).

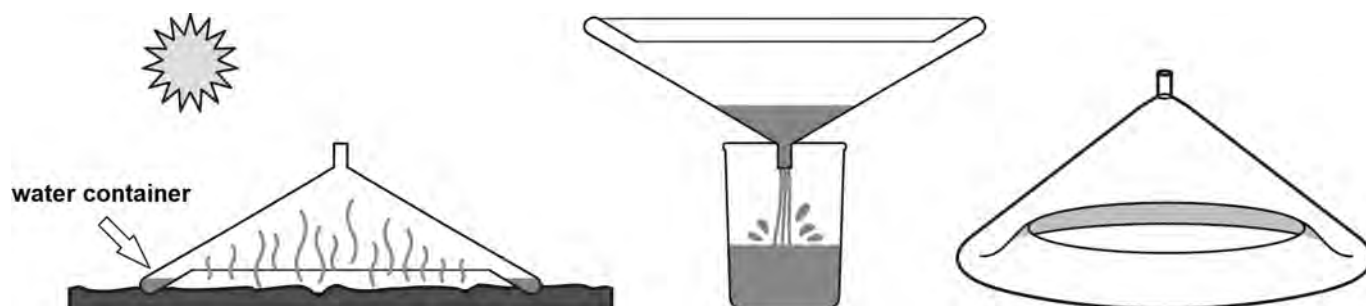
### 3. An exemplary tool: *Watercone*

This is a set of five different tasks dealing with global problems with drinking water supplies – a topic that should be thoroughly introduced to students at ISCED2 level. Using this set, the teacher may make students realize that although there are water resources enough for people, in many cases water quality is not good enough to make it potable. This set also gives an opportunity to show students that current technologies are able to transform polluted water into clean fresh water and make them comprehend that the best solutions are the simplest ones: even a very practical device invented in the 21<sup>st</sup> century does not have to be equipped with complicated electronic machinery, so it can be inexpensive and available for general use. They point out that well known processes and physical phenomena are of great practical importance.

#### 3.1. Tool presentation

##### Explanatory note: tasks 1, 2, 3, 4

*In 2008 Stephan Augustin won the „National Energy Globe Award 2008” for a device named Watercone. This cone-shaped device (showed in figure 1), made of special transparent plastic, makes it possible to collect pure drinkable water. It can be used on flat surfaces – ground or water. With the use of a single device 1.6 litre of drinking water can be obtained during a natural day period.*



**Figure 1:** Schematic representation of the Watercone device

#### Task 1

Hereunder some physical processes are listed:

- I. condensation      II. deposition      III. evaporation      IV. sublimation

**Which of the above-mentioned processes occur during the Watercone work?**

- A.  I i II  
 B.  I i III  
 C.  I i IV  
 D.  II i IV  
 E.  III i IV

### Task 2

Decide which factors have crucial influence on the amount of drinking water obtained with the use of the Watercone device.

	Factor	Yes or no?
I.	air pressure	<input type="checkbox"/> yes <input type="checkbox"/> no
II.	insolation	<input type="checkbox"/> yes <input type="checkbox"/> no
III.	air temperature	<input type="checkbox"/> yes <input type="checkbox"/> no

### Task 3

Nowadays many areas of the world suffer from of drinking water deficiency. One of those areas is Khartoum and its suburbs in Sudan. Using a Watercone drinking water was collected simultaneously in the following places:

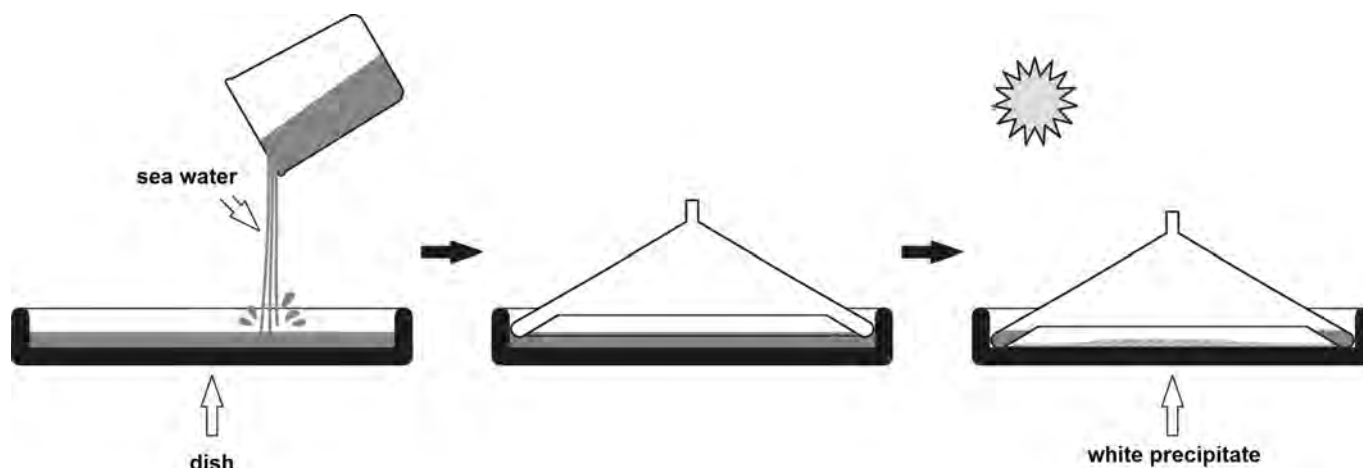
a) On a stone pavement. b) On an arable area. c) On a sand desert. d) In a town pool.

Arrange those places in ascending order according to the amount of water collected.

I.				II.				III.				IV.			
a	b	c	d	a	b	c	d	a	b	c	d	a	b	c	d

### Task 4

The Watercone device can be used with a special attachment (plastic dish) on which the water to be purified is poured (*figure 2*). A Watercone was used to purify seawater during a marine expedition. After the process had been completed, white solid precipitate appeared on the dish surface.



**Figure 2:** Scheme of fresh water production from salt brine using the Watercone

Seawater mineralization analysis showed that it contained the following ions:  $\text{Na}^+$ ,  $\text{Cl}^-$ ,  $\text{Mg}^{2+}$ ,  $\text{SO}_4^{2-}$ ,  $\text{Ca}^{2+}$ ,  $\text{K}^+$ ,  $\text{CO}_3^{2-}$ ,  $\text{Br}^-$ .

Which of the substances listed in the table below might have appeared in the white solid precipitate? Which kind of inorganic species do they represent?

chemical formula	Is it one of the precipitate components?	This substance is representative for			
NaOH	<input type="checkbox"/> yes / <input type="checkbox"/> no	<input type="checkbox"/> oxides	<input type="checkbox"/> hydroxides	<input type="checkbox"/> acids	<input type="checkbox"/> salts
KCl	<input type="checkbox"/> yes / <input type="checkbox"/> no	<input type="checkbox"/> oxides	<input type="checkbox"/> hydroxides	<input type="checkbox"/> acids	<input type="checkbox"/> salts
NaCl	<input type="checkbox"/> yes / <input type="checkbox"/> no	<input type="checkbox"/> oxides	<input type="checkbox"/> hydroxides	<input type="checkbox"/> acids	<input type="checkbox"/> salts
MgSO <sub>4</sub>	<input type="checkbox"/> yes / <input type="checkbox"/> no	<input type="checkbox"/> oxides	<input type="checkbox"/> hydroxides	<input type="checkbox"/> acids	<input type="checkbox"/> salts
Ca(OH) <sub>2</sub>	<input type="checkbox"/> yes / <input type="checkbox"/> no	<input type="checkbox"/> oxides	<input type="checkbox"/> hydroxides	<input type="checkbox"/> acids	<input type="checkbox"/> salts
CaCO <sub>3</sub>	<input type="checkbox"/> yes / <input type="checkbox"/> no	<input type="checkbox"/> oxides	<input type="checkbox"/> hydroxides	<input type="checkbox"/> acids	<input type="checkbox"/> salts
MgO	<input type="checkbox"/> yes / <input type="checkbox"/> no	<input type="checkbox"/> oxides	<input type="checkbox"/> hydroxides	<input type="checkbox"/> acids	<input type="checkbox"/> salts

#### 4. Commentary to the Watercone set – detailed tasks discussion

To give the correct answer in **task 1** (MCQ–type), one has to fulfil the following requirements: a) Notice that figure 1 shows the construction of the device, while figures 2 and 3 show the stages of obtaining drinking water using the Watercone; b) Comprehend all the phenomena which occur during the process and realize that above 0°C water changes in state from liquid to gas (water vapour) and from gaseous state to liquid; c) Spot that at temperatures below 0°C there is no possibility of obtaining water using the *Watercone*.

The main difficulty of this task is that one has to imagine the whole cycle of water state changes which occur while water treatment is carried out in the device. During the lesson the teacher has to play a very important role – she or he has to verify students' ideas about the device operation and the processes which take place during the Watercone work. Another problem more may be taken into account while this task is being discussed: the role of convection in a self-contained environment.

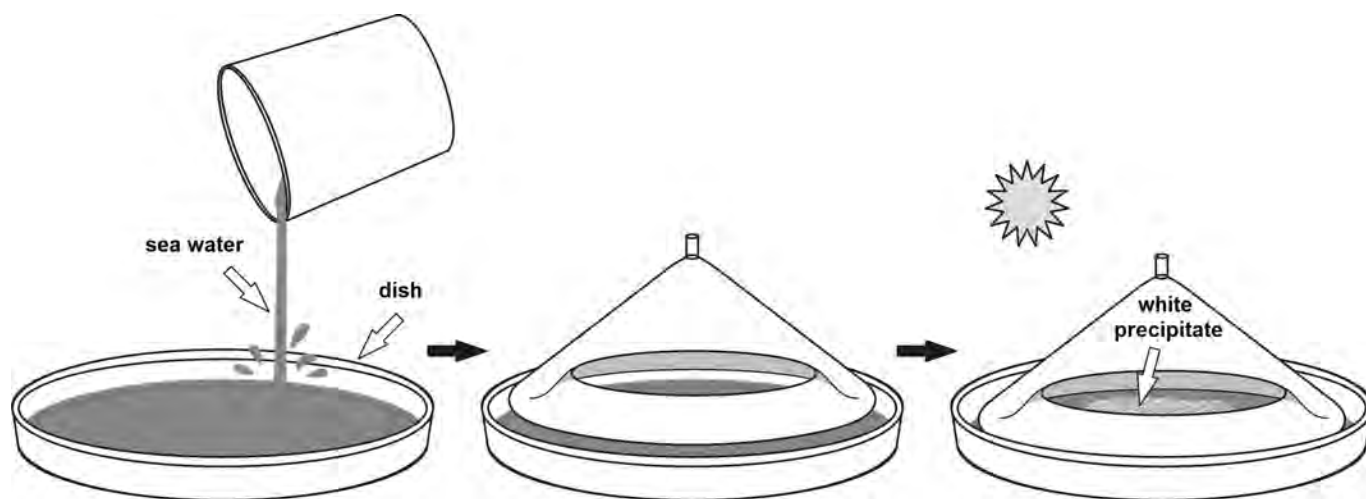
In the **second task** (which is a multiple True-False-Choice item) students' thoughts are guided to the processes rate in the Watercone. To give the right answers students have to be aware of the fact that: a) some external factors have influence on the processes which take place during water purification in the device, b) evaporation is of the processes of critical importance for the amount of water obtained in the Watercone c) evaporation process rate is strictly related to temperature d) insolation has great influence on the temperature inside the working device.

There should be a direct correlation between answers that students marked in this task to the answers given in task 1. Understanding of the processes that water undergoes in the Watercone is sufficient to give the the correct answer in this task.

The author of **task 3** supposes that the main difficulty of this task will be its form. It makes teachers responsible for clarifying the way of matching answers in this task – the explanation that the arrowhead shows the increasing values of the amount of water collected and it is required that the student should give one answer in each of the four columns of the table in the exercise. To give the correct answer one has to know that the water collected in the Watercone originates from the ground and not only does its amount depend on the temperature inside of the device, but also on the humidity of the surface on which the Watercone is situated.

The explanatory note to **task 4** (complex multiple choice item format) presents a scheme of fresh water production from salt brine. A student should analyze it and conclude that in the Watercone only the water changes in state of matter and the other substances (dissolved in water) will appear on the plastic plate as white precipitate after the evaporation process has occurred. Some students might have problems with the understanding of the scheme shown in figure 2. If so, the teacher may exhibit figure 3 to them and ask them to describe it.





**Figure 3:** Easier equivalent to figure 4

The problem presented in this task is a complex one. To give the correct answer, the student has to know a) that only the electrolytes dissociate into ions, b) how to choose the electrolytes from substances given in the table, and c) how to classify them into different groups of inorganic substances. This task can be easily modified by reducing the number of lines in the table.

## 5. Summary

In 2008 the Polish educational system underwent a major reform, which consisted in introducing a new science curriculum. In 2012 for the first time the final external exams were taken by students who were taught in conformity with the new curriculum. The new curriculum encourages to take a closer look, within teaching process, not only on students' knowledge, but also on their skills, especially the complex ones, and their abilities. The final exam formula has changed as well: the test in natural science are separated from the mathematical one, and history are prepared separately from the Polish language one. All of the tasks in science, history and social studies are closed questions. It is very important that teachers be supported under those changes. Educational Research Institute assists teachers and students providing them with professional diagnoses and teaching aids.

## 6. Acknowledgements

This project is cofunded by European Union within European Social Fund.

The authors would like to express their gratitude for precious remarks and help in preparing the present paper to S. Żuchowski and M. Figa.

## References

- [1] Leaflet about Education with Enthusiasm, Educational Research Institute, <http://www.eduentuzjasci.pl/en/>
- [2] Ewa Bartnik *et. al.*, Polish Science Curriculum - Podstawa programowa z komentarzami Vol 5. Edukacja przyrodnicza w szkole podstawowej, gimnazjum i liceum przyroda, geografia, biologia, chemia, fizyka, Ministry of National Education, Warszawa 2009, *in Polish*
- [3] Barbara Ostrowska, Krzysztof Spalik *et al.*, Umiejętności złożone w nauczaniu historii i przedmiotów przyrodniczych – pomiar, zadania testowe z komentarzami, IFiS PAN, Warszawa 2010, *in Polish*
- [4] Haladyna T.M., Downing S. M, Rodriguez M.C., *Appl. Meas. Educ.* 2002, 15(3), 309–334

## Changes in visualization of micro-world in textbooks and in chemistry teaching at lower stages of education in Poland

Paweł CIEŚLA, Małgorzata NODZYŃSKA

*The Pedagogical University of Kraków,  
Institute of Biology, Section of Chemistry and Chemistry Education,  
Podchorążych 2, 30-084 Kraków, Poland,  
email: pawel.ciesla.33@gmail.com, phone +48126627882  
email: malgorzata.nodzynska@gmail.com, phone +48126626345*

### Abstract

*Chemistry is very specific subject. Understanding it abstract thinking and spatial imagination. In Poland, reform of education system allowed to use a wide range of textbooks for each subject, including chemistry. Each textbook approaches in a different way to model micro-world. A lot of drawing models of the same substance or process generates chaos in pupils minds. Moreover, presented drawings are very often based on outdated theories or generate in pupils' erroneous image of micro-world. Therefore there is a need for development of one unified model which is based on newest achievements in chemistry which should be simplified to be able to be used in chemistry education at lower education levels. The requirements what features that model should present are presented.*

**Keywords:** visualisation in chemistry education, micro-world, dynamic models, textbooks,

In the process of education at school a textbook plays very specific role. Its leading position among various sources of information results from its structure. The textbook passes the scientific knowledge that is systematic well organised and ordered. The content of the textbook can be presented in various ways, such as written words, schemes, equations as well as illustrations. Decades ago, due to technical capabilities and costs of printing in the textbooks the verbal presentation of the content dominated. Recent years the role played by illustrations highly increased.

Chemistry is very specific subject because the chemical processes occur at the micro-world level but its effects can be observed in the macro-world level. On the other hand processes that are observed with our senses can be explained only in the invisible micro-world. Understanding such processes requires abstract thinking and spatial imagination. It is why chemistry is said to be a difficult subject at school, especially at lower stages of education. For example writing a simple chemical equation that presents a reaction between acid and base a pupil has to proceed in his mind about fifty single steps [1], but first of all the pupil should understand what happens when acid and base are mixed together and what are the reasons of such behaviour. Students can observe macroscopic effects of the reaction but for most of them verbal explanation what happens at microscopic level is not enough. The results of the exams in the high schools show that many pupils have troubles with interpretation of written words. They can learn definitions and other information by heart, however without understanding its meaning. In order to enable pupils easier assimilation of the knowledge the graphical models are useful. The usefulness of models in chemistry education and its effects on the assimilation of chemical contents at different levels of education was previously examined [2-5].

Several years ago pictures and drawings in chemistry textbooks played mainly illustrating role and they were included as an additive to the text. They were frequent, however they rather showed macro-world concepts and phenomena or schemes than micro-world. Nowadays illustrations are used as a way of passing the knowledge equally to verbal description. In chemistry teaching they are very important since they help young people to create their own image of invisible micro-world, so that they have to be fac-

tually correct. In Poland, after the reform in 1999, the education process is divided into a few stages: pre-school, six-year primary school, where there are two phases of three years, followed by 3 years of study in middle school. Education can be continued in various secondary schools. This reform also introduced significant changes in the curriculum. The improvement of the quality of education was the supposed effect of that change. Another result of that reform was diversification of textbooks and curriculum. The textbooks must be approved by the Ministry of Education after the reviewing process. A teacher makes decision which textbook to choose for teaching. As a result of that change a lot of textbooks for chemistry teaching appeared, published by various publishing houses. Each textbook has its own graphical layout and the way of presenting the content. Thus each textbook approaches in a different way to model atoms, molecules, ions, and chemical reactions. The full flexibility in the presentation of illustrations of micro-world in Polish textbooks resulted that appeared models which correctness, usefulness and efficiency in teaching process have not been verified. The models presented in textbooks are either erroneous or outdated and inaccurate:

- In general, the relative sizes of atoms, ions and molecules are not kept,
- the shapes of molecules very often are incorrect;
- the ionic structure of some substances is not taken into account (for example hydroxides),
- the models of chemical reactions show quantitative relationships of substrates and products but how the process really occurs is not shown.

Some processes which are described in textbooks are based on outdated theories:

- the Arrhenius theory is used instead of Brønsted one;
- the Bohr model of atom is used and instead of model based on achievements in quantum chemistry.

More detailed description of misconceptions and errors in the illustrations in Polish textbooks can be found in a separate paper [6].

Moreover, the appearance of a great number of examples of models of microworld found in textbooks (especially that show the same substance or process, sometimes in completely different and outdated ways) cause another problem. Based on these models pupils are confused. They do not know which model is correct, they create their own image of micro-world based on wrong assumptions and guidelines. In consequence incorrect image of micro-world is created in their minds. The effect of misconceptions on pupils' imagination on structure of matter was previously reported [7-9]. The misconceptions are not easy to diagnose and therefore difficult to replace with correct information. Therefore there is a need for development of one unified model which is based on newest achievements in chemistry which should be simplified to be able to be used in chemistry education at lower education levels.

In the Department of Chemistry and Chemistry Education of Pedagogical University of Kraków there were developed guidelines on how the graphical propaedeutic model of micro-world should be constructed.

The first and basic assumption was that the new proposed model for teaching about micro-world of chemistry and other corresponding visual teaching aids were factually correct. This model should show the spatial structure of the micro world. Moreover, it should take account of the theory of Brownian motion, showing the movements of molecules, ions, atoms, both in liquids and gases (speed of movement depends on the physical state of the substance and varies with the temperature), while in solids it should show the vibrations of atoms or ions in the crystal lattice nodes. It is suggested that static models should be replaced with dynamic ones. Instead of printing in textbooks for example they could be placed in the internet database and authors of textbooks, teachers, pupils could use that universal models.

In the proposed model:

- relative proportions among the sizes of atoms of various elements, both free and bonded in chemical compounds are preserved.
- there is a difference between the size of individual atoms and ions arising from them (real sizes of atomic radii are taken into account and the relative proportions are preserved);

- complex molecules and ions are shown with their real shapes;
- Atoms, ions and molecules do not have a sharp, clearly marked, boundary and show the construction of the electron cloud in a blur, with no boundaries;
- It is shown that real atoms, ions and molecules are colorless,
- Several simplifications are possible, depending on the level of knowledge of the recipient.

The second and very important assumption was that the teaching aids that show structure of micro-world should not cause bad associations or cause them as least as possible. Therefore, creating a new educational model based on the quantum theory of matter, the graphical capabilities of computers are very useful, because they provide the opportunity to design model which can be very close to ideal, with simultaneous suppression of information which lead to the generation of misconceptions. In Poland there are popular models that are either made of balls with sharp boundaries, sticks or both of them. However, if the ball or sphere models are used pupils think, that atoms are colored because the balls usually are coloured in colour of a substance (for example since sulfur is yellow pupils think that atoms of sulfur are also yellow). Moreover, they also think that atoms and ions are of the same sizes. When ball and stick model is used pupils believe that the chemical bonds connecting the atoms is something external.

Another important feature was that the new proposed model of micro-world for teaching chemistry and other corresponding visual teaching aids were able to apply all the time in the education process, at every education level: from the first information about the structure of surrounding us world for children at primary education level, by the elements of chemistry in nature teaching in classes IV-VI of primary school, chemistry teaching in middle school, finally to a secondary school level of chemistry and the level of studies for non-chemists. The use of that dynamic model can be repeated several times and stopped at particular stage of the reaction which is at the particular moment discussed.

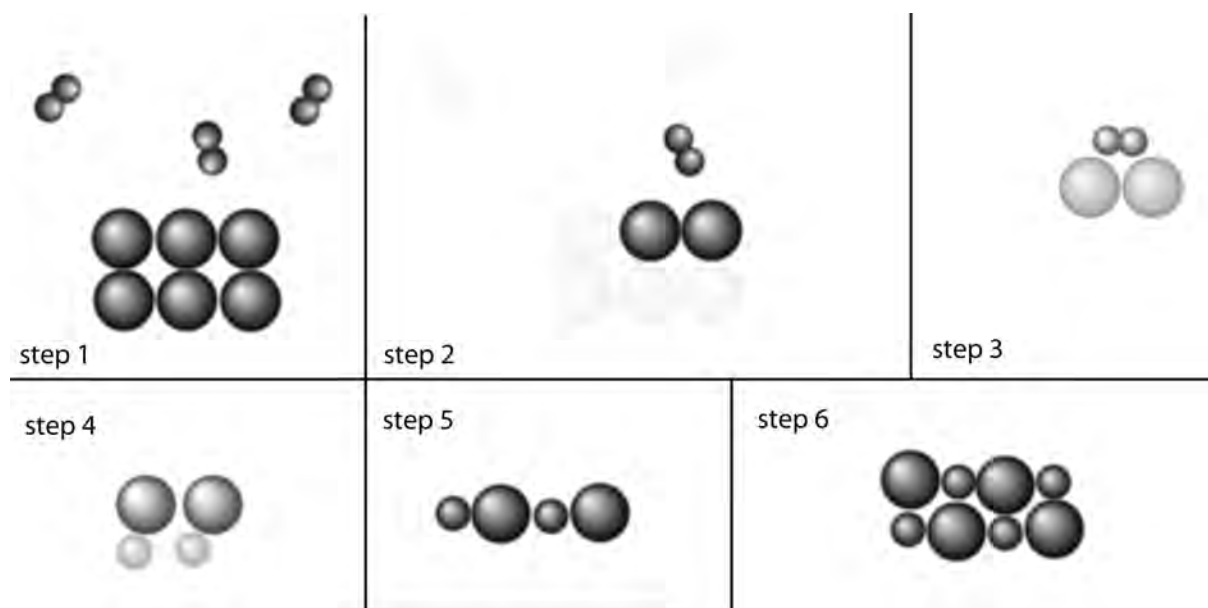
The use of a coherent theory of matter (and corresponding visual teaching aids) would:

- teachers to save their time in the classroom (only one theory instead of the next few theories that pupils have to learn),
- enable students with disabilities to equalize educational opportunities.

Moreover, will be also excluded negative psychological phenomena in chemical education such as:

- the negative transfer (which we have to do if the earlier parts of the material "blocks" understanding of new content, for example the new theory at later stage of education which is difficult to understand because other theory was introduced before which is not in agreement with the new one).
- generalization of stimulus (the phenomenon in which the response associated with the impulse, for example a chemical concept, also acts on other stimuli)
- proactive and retroactive inhibition (it happens when to the one stimulus – term – various connotations are assigned).

Figure 1 shows one of models which meet requirements presented above. The model is dynamic, so that in the picture there are presented screenshots at different moments of the chemical reaction. The fully functioning model and models of another processes can be found at Pedagogical Digital Library of Pedagogical University of Kraków (<http://dlibra.up.krakow.pl:8080/dlibra/dlibra>). The models presented in library are constructed by undergraduate students in frames of Didactics of Chemistry course.



**Figure 1** Model of reaction of magnesium with oxygen (screenshots – complete model available at Pedagogical Digital Library, Pedagogical University of Kraków, Poland (<http://dlibra.up.krakow.pl:8080/dlibra/dlibra/doccontent?id=2908&dirids=1>))

## Conclusions

In some newest textbooks there are visible changes in models presented. The models remain spatial and they are of proper shape. Moreover the electron cloud is blurred, the relative sizes of atoms, ions and molecules are corrected, however still there is no universal model used. It is better to use dynamic models of micro-world instead of static ones since that models better describe real micro-world. Work on dynamic models should be continued and that models should be improved. A good idea would be to create a database of such universal models. This could be the database of an international character, which would allow unification of chemical education in different countries and gave foundation to create a coherent educational area on the higher levels of education.

## Reference list

- [1] P. Cieśla J.R. Paško: Dlaczego pisanie równań reakcji chemicznych, w których powstają sole przysparza uczniom wiele kłopotów? In: Soudobé trendy v chemickém vzdělávání: aktuální otázky výuky chemie XVI, Gaudeamus, Hradec Králové, 2006
- [2] M. Nodzyńska: Wpływ modeli graficznych występujących w podręcznikach do nauczania chemii w gimnazjum na wyobrażenia uczniów o mikroświecie w świetle badań. In: J.R. Paško (ed.) Badania w dydaktyce chemii, Kraków: Wydawnictwo Naukowe AP, 2004, pp. 153-157
- [3] L. Talley L. Journal Res. Science Teaching, 1973, 10, 263
- [4] M. Nodzyńska: Modelowanie reakcji chemicznych w podręcznikach chemii dla liceum ogólnokształcącego. In: K. Myška, P. Opatrný (eds.) Modelování ve výuce chemie, Hradec Králové: Gaudeamus, 2005, pp. 56-58
- [5] M. Nodzyńska: Wpływ wizualizacji procesów zachodzących w roztworach wodnych na stopień ich przyswojenia przez uczniów. In: J. Šibor (ed.) Mezinárodní seminář didaktiků chemie, Masarykova univerzita, Brno, 2004
- [6] M. Nodzyńska, J.R. Paško, P. Cieśla, Journal of Science Education, vol. 13, 2012, pp. 28-33.
- [7] M. Nodzyńska: Rola nieprecyzyjnych rysunków w tworzeniu się błędnych wyobrażeń u dzieci w nauczaniu przyrody. In: ScienEdu Aktuálne trendy vo vyučovaní prírodovedných predmetov, Univerzita Komenského v Bratislave, May 2007, pp. 321-324
- [8] J.R. Paško: Cząsteczki czy jony: jak nauczać o strukturze mikroświata. In: M. Bilek (ed.) Aktuální otázky výuky chemie 9, Hradec Králové: Gaudeamus, 2000, pp. 152-155
- [9] J.R. Paško: Rola wyobrażeń w procesie edukacji chemicznej. In: M. Bilek (ed.) Aktuální otázky výuky chemie, Hradec Králové: Gaudeamus, 2005, pp. 87-92

## Approaching Chemistry with an historical museum: museology and didactics with historical instruments

Laura COLLI, Antonio GUARNA, Mariagrazia COSTA

Dipartimento di Chimica "Ugo Schiff", Polo Scientifico e Tecnologico dell'Università degli Studi di Firenze,  
Via della Lastruccia 3-13, 50019 Sesto Fiorentino (Firenze) - Italy - e.mail laura.colli@unifi.it phone: 333-1147101  
<http://www.unifi.it/dipchimica/CMpro-v-p-330.html>

### Summary

From 2008, thanks to the founding of the Ente Cassa di Risparmio di Firenze, *CHEMICAL HERITAGE* project has started, with the aim to conserve the historical-chemical founds of the "Ugo Schiff" Chemistry Department of University of Florence. Now "Chemical Heritage –Ugo Schiff" is a little University Museum, not yet officially recognized as "museum" but with goods of great importance, first of all those related to Ugo Schiff. The elements conserved, for a total of one thousand and five hundred objects, are divided in four collections and are actually under analysis. Such an historical museum can make students approach to Chemistry for many reasons: thanks to the ancient instruments it is possible to watch "inside" the measurement machines and moreover the allure of old founds can excite the curiosity about their functioning in the young people.

**Key words:** Historical Chemistry Museum, Chemical Heritage, Schiff.

In this talk I will introduce Florence Chemistry Museum and how this can make approach to Chemistry students and young people. Since 2008 "CHEMICAL HERITAGE" project is operating for conservation and valorization of the historical-chemical founds present on "Ugo Schiff" Chemistry Department of University of Florence. "Chemical Heritage - Ugo Schiff Museum" is a little University Museum, not yet officially recognized as "museum" but that conserves many historical chemistry objects, also of great importance [1].

The *CHEMICAL HERITAGE* project is directed to protection and exhibition of the finds, but also to deepen the historical and scientific aspects related to them, through bibliographic, historical and archival researches [2] [3].

The objects conserved are more than one thousand, among instruments, documents, synthesis products and nineteenth-century furniture of chemistry laboratory (Figure 1). The most ancient part of them is related to Ugo Schiff (Frankfurt am Main 1834 – Florence 1915), the discoverer of *Schiff bases* and *Schiff reactive* [4]. Schiff had worked in Florence for fifty years and he is considered the founder of Florence chemistry school [5] [6] [7].

In particular we conserve: the original furniture of Schiff laboratory; the official documents and all his scientific and private correspondence (*Carteggio*, today under analysis); scientific instruments; ancient photos and many original synthesis products, among which also those for the *Schiff bases* [1].

Moreover in the museum are conserved other historical collections: the *Historical Instruments Collection* (constituted by one hundred and fifty instruments dated from the Nineteenth century to the Fifties of Twentieth century); the *Bigiavi Collection* (approximately composed by two hundred chemical products of synthesis from the Twenties); the *Historical Furniture Collection* (that includes about thirty elements among which laboratory benches, cupboards and ancient furnitures); the "*Ricettario Fiorentino*", the first European pharmacopoeia in the edition of the year sixteen ninety four; and other collections, related to more recent chemistries (*Piccardi Collection*, *Speroni Found*) [1] [8] [9].



**Figure 1.** A view of the “museum” (a) and an original (b) chemistry bench

Aim of the project is on the one hand to conserve this historical chemical heritage, to the other hand is to spread the knowledge of it, with conferences and publications, to the experts but also to the students and the common people (Figure 2). For example, the presence of the museum has increased the familiarity with the figure of Ugo Schiff. Before of this project many students didn't know him, while now, thanks to the conferences and to the historical pictures in Department, this knowledge is grown. To check it, we have prepared a quiz that we use to interview students year after year, in order to test if the knowledge about history of chemistry really grows together to the Chemical Heritage project.



**Figure 2.** Retrieval (a) and cleaning (b) of ancient original synthesis products

We think that an historical museum can positively approach the young people to the chemistry for several reasons:

1. The first is that the students can watch directly the objects related to some great discovers, that usually they have seen only in the books (for example, in our case, the *Schiff bases*), and in addition they can note that great inventions have been made just by men with tangible objects; often also with very simple objects.
2. The second reason is the evocative allure of the old instruments, as proven by the great success of public we registered in the occasions in which these instruments have been shown.
3. The third reason is the sense of belonging to an ancient and glorious school and this can stimulate the young people to pursue great results not only for themselves but for all the scientific community of which they are members.

Finally the old instruments are often the “progenitors” of the modern ones and permit to the students, that nowadays often see only the first and the final part of a process (often through a computer), to watch

“inside” the machine and to understand its functioning.

We suggest two historical experiments for the didactics: spectroscopy of some luminous sources and chromatography on thin layer.

Spectroscopy is used for identifying the substances, chromatography for separating some components of a product. We have chosen these experiments because they are simple to realize, do not rise risks for the historical objects and do not ask for any particular equipment.

For the spectroscopy we use a Nineteenth century spectroscope with photographic chamber and tub for liquid sample (Figure 3). The experiment consists in watching the difference between the spectra of a mercury lamp, a neon lamp, an incandescent lamp and the sun. The mercury lamp and the neon lamp will give an emission spectrum with the characteristic emission lines of the elements (Mercury and Neon, Neon often also with Argon). The incandescent lamp will give a continuous spectrum, the sun a continuous spectrum with the characteristic absorption lines, called *Fraunhofer lines*. It is possible to measure the wavelength and identify the luminous source.



**Figure 3.** The spectroscope used for the didactics experiments (a), its photographic chamber (b) and Ugo Schiff lecture notes, in which it is described (c)

For the chromatography we used a glass cylinder with the top, glass plate with silica gel and a green leaf as a sample. We press the leaf in a mortar with a solvent, leave a drop on the glass plate, put it in the cylinder in which there is a part of solvent and lose the top, wait the complete formations of the spots and finally read the result. We observe some colored spots that correspond to the separate substances: basing on the intensity of the color it is possible also a quantitative analysis. For the green leaf we obtain three chlorophyll (green and blue), the xanthophyll (yellow) and three carotenes (orange). This is an ancient technique: the color of the spots allows to see easily the separation.

These simple but not trivial experiments have the quality to join the use of the historical objects to results that are visually satisfying and that make easier the comprehension of the processes.

Our dream is that our project can continue till the rebuilt of an ancient chemistry laboratory with the original furniture, instruments, notes and products (joined to the most advanced multimedia systems) to show how the scientists worked in a chemistry laboratory when chemistry was born.

## Bibliography

- [1] Guarna A., Colli L., Costa M. *Verso un museo di Storia della Chimica a Firenze: il progetto Chemical Heritage*, Memorie di Scienze Fisiche e Naturali, Rendiconti della accademia Nazionale delle Scienze detta dei XL, Atti del XIII Convegno Nazionale di Storia e Fondamenti della Chimica, Volume 127, pag. 391, Roma, 23-26 Settembre **2009**
- [2] Guarna A., Colli L., Costa M. *La prima aula italiana dedicata alla Chimica. Storia della costruzione tra il 1879 e 1884 dell'Aula "Ugo Schiff" di Via Gino Capponi 9 a Firenze*, La Chimica e l'Industria, pag. 104-108, Anno 93 n.3 - Aprile **2011**
- [3] Colli L., Costa M., Guarna A. *Il Testamento di Ugo Schiff: il volto meno conosciuto di un grande scienziato*, Memorie di Scienze Fisiche e Naturali, "Rendiconti della accademia Nazionale delle Scienze detta dei XL", Volume 128, **2011**
- [4] Tidwell, T. T. *Hugo (Ugo) Schiff, Schiff Bases, and a Century of  $\beta$ -Lactam Synthesis*. Angewandte Chemie International Edition, 1016-1020. **2007**
- [5] Gelsomini, N. *Hugo Schiff e l'insegnamento della chimica a Firenze nella seconda metà dell'800*. Atti del II Convegno Nazionale di Storia e Fondamenti della Chimica, 189. **1988**
- [6] Gelsomini, N., Costa, M., Manzelli, P., & Fiorentini, C. *La chimica a Firenze tra '800 e '900*. Atti del IV Convegno Nazionale di Storia e Fondamenti della Chimica, 383. **1992**



- [7] Garin E. *La cultura a Firenze al tempo di Ugo Schiff*, Atti e memorie dell'Accademia fiorentina di scienze morali La Colombaria Vol. 59, n. 45 p. 201-216, **1994**
- [8] Rocca, S. V. *Beni culturali e catalogazione: principi teorici e percorsi di analisi*. Roma. Gangemi stampa. **2002**
- [9] Corti, L. *I beni culturali e la loro catalogazione*. Milano. Mondadori. **2003**

## A Haptic-Enhanced Framework for Chemistry Education

Enzo BERGAMINI<sup>1</sup>, Sara COMAI<sup>2</sup>, Fulvio CORNO<sup>3</sup>, Gabriele CRISTINI<sup>4</sup>, Guglielmo LANZANI<sup>5</sup>,  
 Davide MAZZA<sup>2</sup>, Pierangelo METRANGOLO<sup>6</sup>, Giuseppe RESNATI<sup>6</sup>, Giancarlo TERRANEO<sup>6</sup>  
 Gianluca BRERO<sup>a</sup>, Rosa Virginia Espinoza GARNIER<sup>a</sup>, Elisa MAGNANELLI<sup>a</sup>, Khalid MAHMOOD<sup>a</sup>,  
 Giacomo MAZZOLETTI<sup>b</sup>, Stefano PASCALI<sup>a</sup>, Alessandro RIZZI<sup>b</sup>

<sup>1</sup>Teoresi Group s.r.l., via Perugia 24, Turin, Italy

<sup>2</sup>Politecnico di Milano, Dipartimento di Elettronica e Informazione, via Ponzio 34/5, Milan, Italy

<sup>3</sup>Politecnico di Torino, Dept. Control and Computer Engineering, c.so Duca degli Abruzzi 24, Turin, Italy

<sup>4</sup>Politecnico di Milano, METID, p.zza Leonardo da Vinci 32, Milan, Italy

<sup>5</sup>CNST-IIT@POLIMI - Istituto Italiano di Tecnologia, via Pascoli 70/3, Milan, Italy

<sup>6</sup>Politecnico di Milano, Dipartimento di Chimica, Materiali ed Ingegneria Chimica "Giulio Natta", via Mancinelli 7, Milan, It

<sup>a</sup>Alta Scuola Politecnica, Politecnico di Torino

<sup>b</sup>Alta Scuola Politecnica, Politecnico di Milano

E-mails:

sara.comai, gabriele.cristini, guglielmo.lanzani, davide.mazza, pierangelo.metrangolo, giuseppe.resnati, giancarlo.terraneo@polimi.it,  
 fulvio.corno@polito.it, enzo.bergamini@teoresigroup.com

### Abstract

*Haptics is the technology that exploits the human sense of touch by allowing users to apply or feel forces and vibrations through the human body. It can be greatly helpful in the chemistry education context, where the forces involved in chemical recognition processes can be directly simulated and felt through a haptic device. This paper presents a virtual environment for the exploration of the space around a molecule, where the electrostatic surface can be explored with a haptic device, to better understand the forces involved in intermolecular interactions. After a brief description of the architecture of the framework, the paper describes some didactic scenarios and discusses ongoing and future works.<sup>1</sup>*

**Keywords:** Haptics, intermolecular interactions, Supramolecular Chemistry, simulation, force feedback.

### 1. Introduction

Haptics is the technology that exploits the human sense of touch by allowing users to apply or feel forces and vibrations through the human body. This way of interaction can be greatly helpful if applied in contexts where forces exert a key role in describing natural interactions. Chemistry is definitely one of these realms: the forces involved in chemical recognition processes can be directly simulated and felt by a training system through the usage of a haptic device. At this aim, we have developed a virtual environment for the exploration of the space around a molecule, where the electrostatic surface and its influence on the surrounding objects can be explored with the help of a haptic device, to better understand forces involved in intermolecular phenomena. A deep understanding of these forces that govern the recognition processes is fundamental in chemistry teaching: didactic books basically describe molecular interactions as bounds due to permanent or temporary imbalances of charge around the molecule surfaces. Instead in computer science, interactions among molecules are typically described as huge sequences of data, which determine how the attraction/repulsion forces take place: this huge amount of data is awkward to be interpreted even by experts of the field.

This work describes an innovative tool which is able to provide a new approach in the exploration of the landscape of intermolecular interactions. In particular, haptic interaction allows the user to *feel* the interaction forces, thus improving interpretation of such data for different didactic purposes. The frame-

<sup>1</sup>This work has been done in the context of the *HaptiChem* project, an interdisciplinary project carried out within the Alta Scuola Politecnica, an international school for young talents from Politecnico di Milano and Politecnico di Torino that promotes innovation in the fields of engineering and science, with the collaboration of external institutions and industrial partnerships.

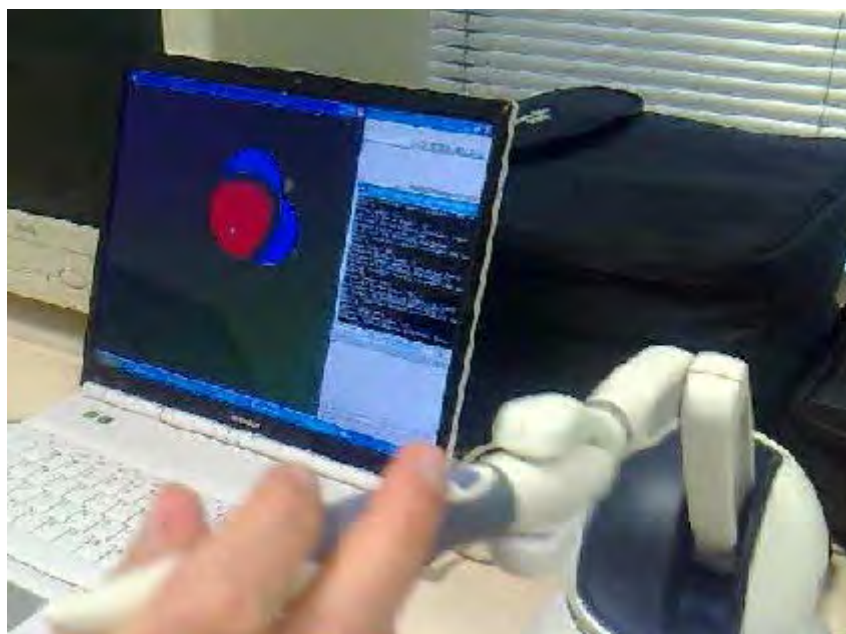
work is also enriched with visual cues and auxiliary data to ease the comprehension of the theoretical concepts underlying the described phenomena.

The application goes beyond the human imagination deriving from merging the theoretical concepts and the personal capability of abstraction: the user is projected into a different and higher learning level, the one of sensation. Therefore, something physically untouchable becomes virtually touchable. This kind of experience, associated to the user's personal background, will allow a deeper comprehension of molecular and intermolecular phenomena. The fundamental novelty of this work is the use of a computational approach instead of an analytical one in simulating molecular behavior: this method leads to a more realistic representation of the molecular dynamics.

## 2. Architecture of the system

The framework is based on a software with a visual interface. The computer is matched with a cable to the Sensable PHANTOM. As shown in the right-hand side of the Figure 1, it is a robotic arm with a terminal structure similar to a stylus that user can hold in his hand.

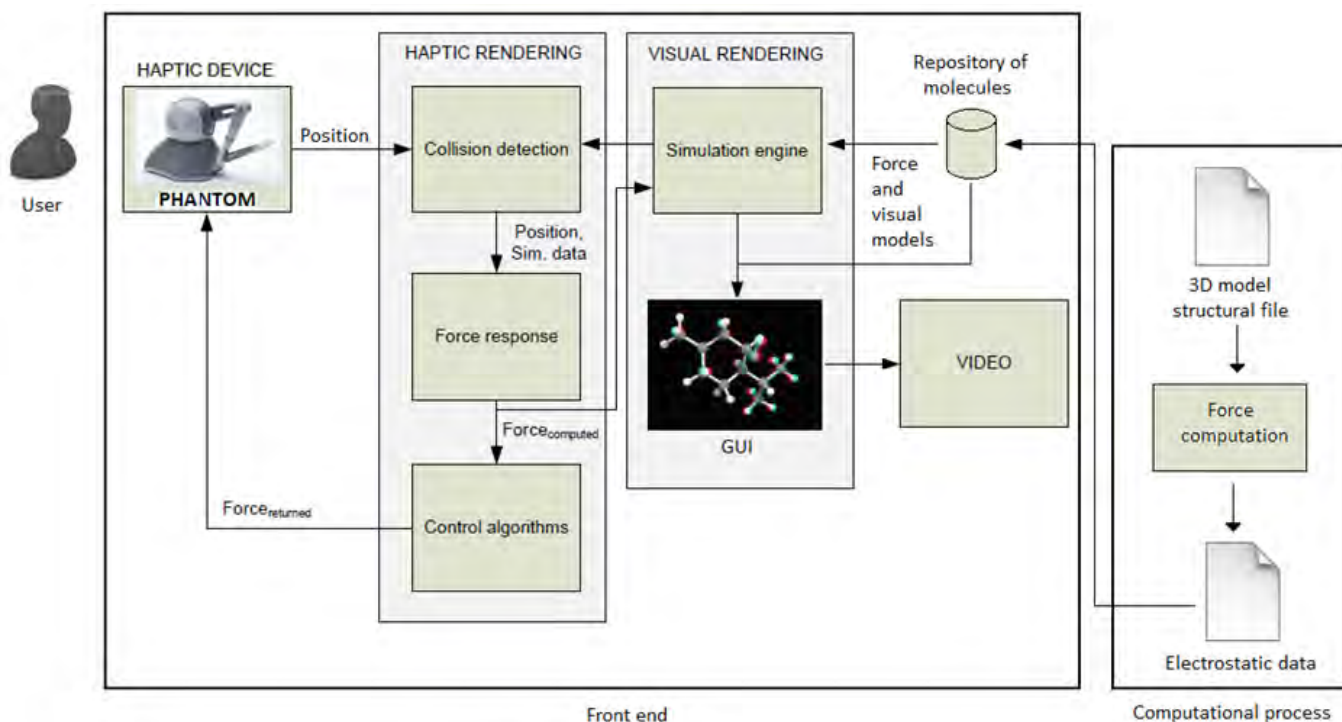
The interface shows to the user a molecule with its geometrical three-dimensional structure. The user can move the stylus of the haptic device as a *pointy cursor*, in the virtual environment. The cursor of the probe can be associated with an electric charge, set either with positive or with negative values: while navigating the 3D space around the molecule, the user gets the feeling of the forces of the electrostatic interaction between the charge and the molecule. The molecule can be chosen from a *repository* of molecules.



**Figure 1** The tool at work in our laboratory

Figure 2 sketches the architecture of the main components of our system. To model the simulated phenomena, two kinds of information are used:

- The (3D) *geometrical data*, which determines how the molecule is structured and the atoms spatially displaced. The geometrical information are mainly used for molecule visualization in the three-dimensional working space, and as input for the computation of electrostatic information.
- The *electrostatic field data*, which determine the intensities of the electric field around the molecule, and thus the forces to be applied on the haptic device.



**Figure 2** The architecture of the tool

For the geometrical representation of the molecule, we have used a structural format widely adopted in experimental chemistry, the .PDB file format.

The electrostatic field data are instead used for the computation of the force field around the molecule. The force computation is based on the geometrical information of the molecule. Computational chemistry tools, like GAME and wxMacMolPlt, can indeed provide as output the electric field values of the molecule needed to model the interaction force. GAMESS start from the 3D geometrical data of the molecule and provides as output a set of numerical values representing different properties of a molecule, adopting a quanta-mechanical modeling of the phenomena. Starting from such data, the wxMacMolPlt tool returns the intensities of the *molecular electrostatic potential (MEP)* in a particular position in the space around the molecule. The MEP values are arranged as a *grid of voxels* surrounding the molecule till a certain threshold distance in space. The force felt by the user is the one associated with the voxel of the grid within which the proxy position falls in.

Notice that since our framework is based on data retrieved with the help of a computational chemistry tools used in the chemical research field, it simulates the behavior of interactions in a very realistic way and very close to what scientific research has identified.

Both the geometrical and the electrostatic data are stored in a *molecule repository* from which the user can load any molecule. The tool is therefore easily extendible with the addition of new molecules: only the geometrical and electrostatic data need to be computed.

### 3. Scenarios for educational activities

The developed tool has been realized with a twofold purpose, for being used both for didactic and for research activities. In this paper we focus mainly on the former case: indeed the tool can help students to understand how molecules interact, by experiencing it in a more tangible way. For the latter case we will show a possible application related to the field of halogen bonding, *i.e.*, the intermolecular interactions involving halogen atoms as electrophilic sites [8].

With this tool, students can explore the electrostatic surface of one of the molecules of the repository, and feel where its electric field has its typical values (minima, maxima) or where holes - where molecular bindings take place - can be found in its electronic surface. The system is also able to render the peculiar

characteristics of bindings by providing attractions to molecular binding sites till the real binding distance that would occur during the interactions with other molecules. In that position the probe of the haptic device will stop (*i.e.*, a stable point for the haptic probe movement is found), giving the user exactly the sensation that a binding has occurred.

#### **a. Some possible scenarios for educational activities**

A chemical bond is formed when an electrostatic force holds together: a) atoms in a molecule (this is the case of strong bonds or *intramolecular* bonds) or b) more molecules in a chemical compound (this is the case of weak bonds, or *intermolecular* bonds, which are the subject of our project). The nature of the chemical bond can be explained easily by the existence of an electric field made by the electrons surrounding each atom. Electrons are actually the means through which bonds are formed. If we consider a negative charge placed between the two nuclei of two interacting atoms, it will be exposed to attractive and repulsive forces from the two cores (according to the distance of the electron w.r.t. to nearest and farthest core), till a certain distance (*bond distance*) where the system stability is reached, so that the negative charge will fall into a *potential hole* from which it will be difficult to escape and a chemical bond is formed.

The distribution of the positive and negative charges on the various atoms gives rise to molecular *dipoles*, which are responsible for the intermolecular forces of attraction. Indeed, intermolecular interactions between polar molecules can be considered essentially the mutual Coulombic attraction between dipoles. Several molecules are dipoles due to the non-uniform distribution of electric charge, like for example the water (H<sub>2</sub>O) molecule, where a partial negative charge is present in the vicinity of the oxygen atom and a partial positive charge is present near each of the two hydrogen atoms.

A couple of examples of possible didactic activities involving such concepts are described next.

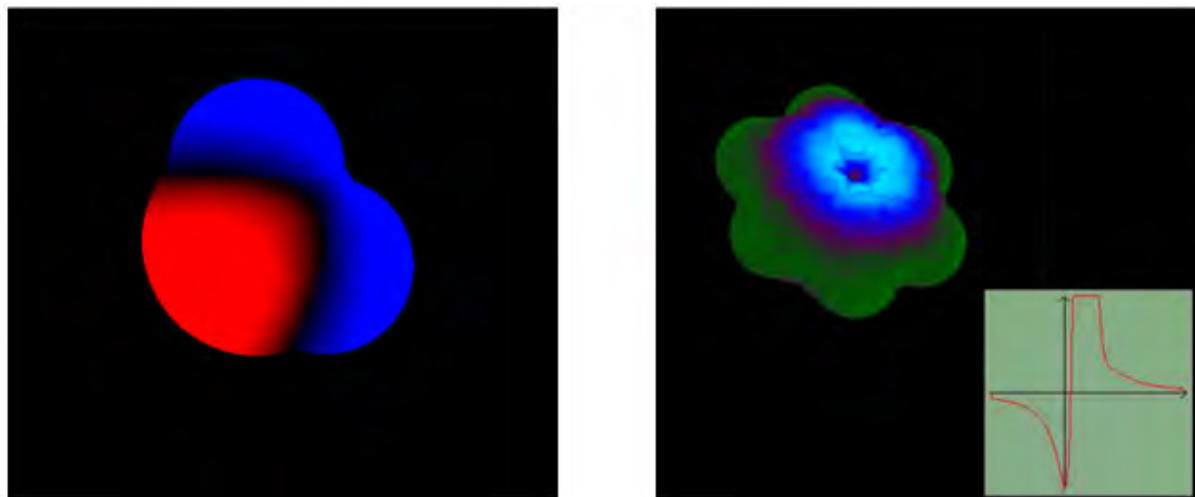
#### ***Experiment 1: Molecule polarity***

The first experiment proposed to the students consists in the analysis of the haptic interaction with a water molecule (H<sub>2</sub>O), which is a permanent dipole and whose interaction in terms of force intensities can be felt significantly in the whole surrounding space. As a dipole, the water molecule always exhibits electric poles over its atoms, because of the different electronegativity of the involved chemical elements. Electric charges can be attracted accordingly, towards the opposite sign's pole (see Figure 3, where the surface of the water molecule is colored according to the electrostatic field values).

Students can feel this phenomenon with the tool where forces, differently with respect to the case of CO<sub>2</sub>, can be felt with non-negligible intensity in the whole space around the molecule, and attraction forces guide the haptic proxy associated with the charge towards the respective pole(s).

#### ***Experiment 2: Critical points detection***

A second experience considers the benzene (C<sub>6</sub>H<sub>6</sub>) molecule (see Figure 3). Although symmetric and planar, positive and negative charges are attracted differently by the benzene molecule. This is clearly difficult to be communicated on paper to the students. The students, in fact, can easily determine with the haptic simulation the critical points in the electrostatic potential surface in the space around a benzene molecule. Such points act like holes of the electrostatic surface and give stability to charge position when reached. This stability is reflected into the non-movement of the haptic proxy handled by the user, which becomes firm in such points. These *critical points* are typically placed where the electrostatic potential presents a minimum. This experience becomes even more interesting when the molecule has a *closed symmetric* geometrical structure, such as the benzene molecule, where holes can be formed inside the molecule, thus *trapping* the charge. This mechanism is typically used for the docking technique in drug design. With the haptic device, students can experience the sensation of reaching the stability in the center of the molecule.



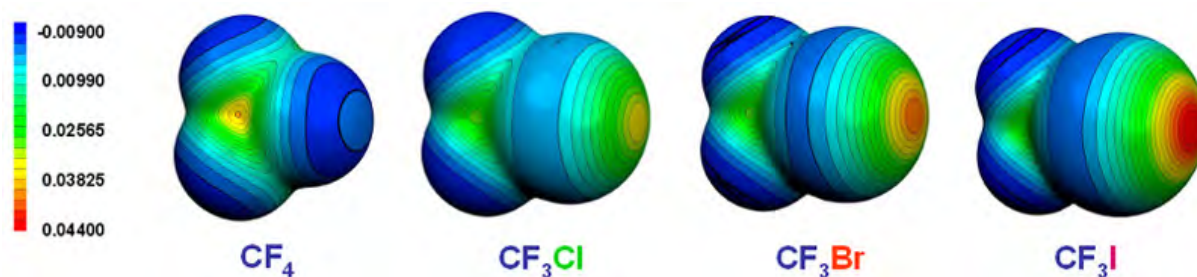
**Figure 3** The molecules of water on the left and benzene on the right with a graph showing a hole of potential

#### **b. A research application: representation of halogen bonding**

A field of application on which we are focusing our attention is the haptic simulation and representation of halogen bonding. A halogen bond  $R-X\cdots Y-Z$  occurs when there is evidence of a net attractive interaction between an electrophilic region on a halogen atom X belonging to a molecule or a molecular fragment  $R-X$  (where R can be another atom, including X, or a group of atoms) and a nucleophilic region of a molecule, or molecular fragment,  $Y-Z$  [9].

Around the halogen atoms the potential is expected to be all negative. However some recent studies based on quantum-mechanical methods showed that in some molecules, as shown in Figure 4, there is a region at the edge of the halogen atoms that has a positive potential.

Our aim will be to try to simulate this behavior with the haptic device, in order to have a direct experience of this interaction, which is relatively poorly known, and to better understand the consequent amphiphilic behavior of halogenated molecules in intermolecular recognition processes.



**Figure 4** MEP on the surface of different halotrifluoromethanes [9]

#### **4. First results and planned activities**

The tool has been preliminarily tested by different kinds of users (students, teachers, researchers) on different molecules stored in the repository. All the users who tested it recognized the possibility of combining the typical visualization of chemical data with the rendering of the *feeling* of atomic/molecular interactions that can improve the understanding of real chemical phenomena: students greatly appreciated the novelty of introducing such a tool in the current teaching activities to better understand the explained concepts; teachers and researchers appreciated the improved awareness of the simulated phenomena they usually explain or deal with theoretically.

From this preliminary study on a limited number of users, it is pretty clear that the usage of such a tool in didactic activities may result in the following positive aspects:

- *increase of motivation*: more interest for the concepts involved in the faced experiences by students;
- *internalization of concepts*: students showing more easiness in the assimilation of the concepts presented through the haptic experience;
- *spatial and intensity perception*: students can understand the different proportions of the involved objects and how the nature and intensities of interactions can be related to spatial properties (*e.g.*, distances from molecule).

We do expect therefore a significant step forward in employing technology-enhanced approaches for learning, also with respect to the classically adopted methods.

At this aim the tool is planned to be inserted as a laboratory activity in parallel with the normal chemistry course held at university. This activity will be attended on a voluntary basis by students who want to improve their knowledge on the chemical subjects discussed during the normal teaching hours, by experiencing a more immersive and innovative way of learning. The laboratory sessions will consist in a *step-by-step* highly guided experience to test the intermolecular behaviors explained in theory with the help of the developed frameworks.

## 5. Conclusions and future work

This paper has described a framework for the simulation of the interaction between a molecule and an electric charge through the use of a haptic device. The user is shown a three-dimensional environment, which can be explored with the device. User experience and the *learning-by-doing* approach can make students able to feel what they are used to know only from textbooks.

Further works will consider the implementation of other kinds of interactions, such as the simulation of molecule-molecule interactions, and the systematic introduction of the framework as a supporting tool to be used for virtual laboratory activities alongside normal university-level courses. Further extensions will aim to model different bonds such as covalent, ionic, hydrogen and van der Waals interactions, in order to compare and feel their differences. We think that this tool may have applications also in secondary level schools.

## References

1. Alta Scuola Politecnica, <http://www.asp-poli.it>.
2. P. Bivall, S.E. Ainsworth, L. Tibell, Science Education, 2011, Vol. 95 (4), 700-719.
3. S. Comai, D. Mazza, Procs. of the 24th BCS Interaction Specialist Group Conference (BCS '10), 2010, 221-229.
4. Rcsb protein data bank, <http://www.rcsb.org>.
5. Sensable Phantom, <http://www.sensable.com>.
6. M.W. Schmidt et al., General atomic and molecular electronic structure system, Journal of Computational Chemistry 14 (1993) 1347–1363.
7. wxmacmolplt Web site, <http://www.scl.ameslab.gov/MacMolPlt>.
8. P. Metrangolo, G. Resnati, Science 321 (2008) 918-919.
9. An IUPAC Task Group set up to examine the definition of halogen bonding has not yet reported, so that given here should be taken as temporary (see [www.iupac.org/web/ins/2009-032-1-100](http://www.iupac.org/web/ins/2009-032-1-100) and [www.halogenbonding.eu](http://www.halogenbonding.eu)). Use of

## Simulator in Teaching Chemistry

Adriano Francisco DA SILVA, Jefferson Leixas CAPITANEO

Instituto Federal do Rio de Janeiro, Avenida República do Paraguai, 120,25050-100, Duque de Caxias-RJ-Brasil.  
E-mail: Adriano.gauss@yahoo.com.br

### Abstract

The teaching chemistry has undergone many changes over time, mainly influenced by scientific discoveries; one of the greatest challenges today is to build new knowledge together with a larger share of the population, increasing access and promoting development. To have a truly inclusive scientific literacy, we must keep in mind that aren't a homogeneous society, respect the potential and promote interaction among the various groups that compose it. This abstract will present the use of a laboratory simulator in teaching experimental chemistry.

**Keywords:** Teaching, chemistry, simulator, interaction, knowledge, access.

### Development

With the objective of to increase the reach and construction of new knowledge in chemistry was developed, with high school students and graduation, a simulator laboratory software, that makes use of image capture technology combined with a graphical interface making possible the realization of numerous experiments.

Local Reality (Rio de Janeiro – Group 1.000 students):

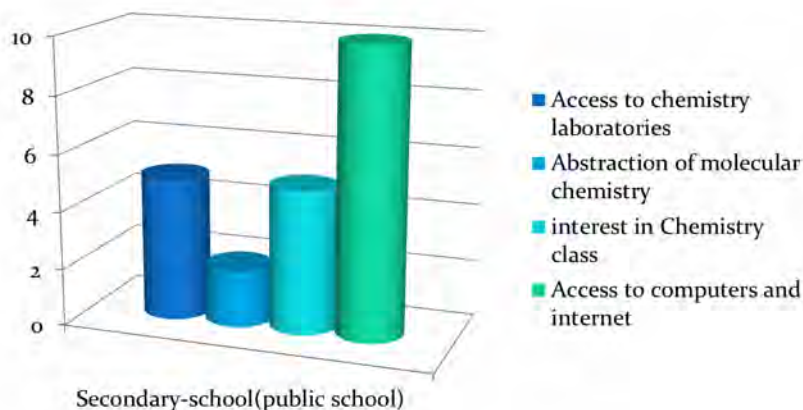
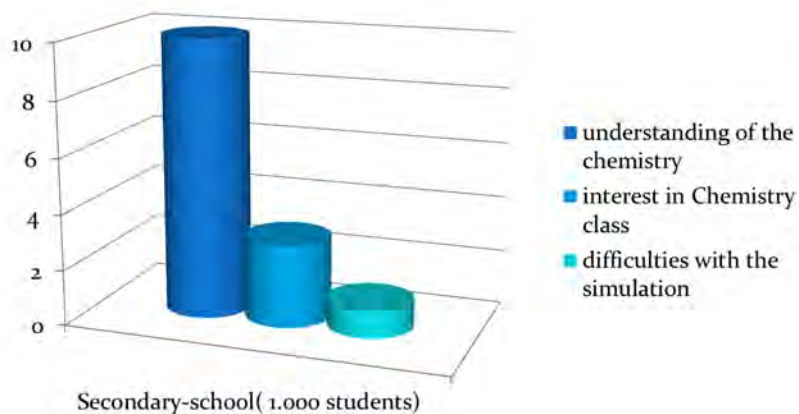


Figure 1. Image of the simulator.



It doesn't work alone, because two actors need to be in complete harmony, the student and teacher. On the computer the student develops the activities oriented by the teacher with laboratory glassware, virtual reagents and webcam to design it in the virtual laboratory. The software uses other multimedia resources that can enrich the content of the subject, such as audio, instructional videos and atomic models. The student observes two videos before starting the practice, containing the historical context and examples of the experiment. The teacher has to intervene and encourage students to question what was being presented, because this interaction was the real agent who promoted immersion in teaching chemistry. Questions after the simulations:



## Conclusion

The project is showing significant results, since its inception in April 2009, as increased understanding and interest in the disciplines and the reduction of accidents in laboratories. On first contact with the tool there is the natural barrier of a new technology and its manipulation, which the young assimilate quickly. The tool proved to be compatible with some expectations of the teaching of chemistry, contributing to the development of themes and having great impact on students and institutions that don't have continuous access to laboratories. The simulator didn't replace the real laboratories, in this process, is an additional resource for teachers and teaching practices.

## Reference

- [1]. LÉVY, Pierre; As Tecnologias da Inteligência. Editora 34.1993.
- [2]. KOTZ, John C.; Química geral e as reações químicas - CENGAGE LEARNING.
- [3]. SILVA, A.L.M.; Simplesmente Cecília: A trajetória recente de uma escola e a educação infantil pública em Duque de Caxias. 2011.

## Journey Around CO<sub>2</sub>: An Interdisciplinary Course

Valentina DEVOTO<sup>1</sup>, Ivana COCCO<sup>2</sup>, Maria Cristina MEREU<sup>3</sup>, Battistina CARZEDDA<sup>4</sup>

*1 Liceo Scientifico "Giuseppe Brotzu", Quartu S. E. (Cagliari), Italy ([valentinadevoto@tiscali.it](mailto:valentinadevoto@tiscali.it))*

*2 Istituto Tecnico Industriale "Michele Giua", Cagliari, Italy*

*3 Liceo Classico "Bachisio R. Motzo", Quartu S. E. (Cagliari), Italy*

*4 Liceo Pedagogico "Eleonora D'Arborea, Cagliari, Italy*

### Abstract

*The activity, developed within the "Piano Lauree Scientifiche" in collaboration with the Department of Chemical and Geological Science at the University of Cagliari, has been carried out by several teachers with their class or groups of students. It mainly concerned the teaching of Chemistry and its links with other scientific disciplines (Biology and Earth Science) with specific reference to their relationship to every-day life. The final product is an interdisciplinary didactic path, with a strong laboratory component, around the central theme of CO<sub>2</sub>. This compound is of particular interest in several scientific fields: from chemistry itself to biology, geology and environmental science, and thanks to the media and popular attention it attracts, it can be utilised to address complex and sensitive discussion topics. In addition it can be used in numerous experiments appropriate for high school curricula.*

### Keywords

interdisciplinary teaching, carbon dioxide, practical work, learning-by-doing approach

### Introduction

The "Piano Lauree Scientifiche" (PLS or Plan) started in 2005 in order to attract students in their last year of high school to the Faculties of Chemistry, Physics, Mathematics, and Materials Science for which a lower number of applications had been previously registered.

The Plan, in addition to giving the students an opportunity to work in a university laboratory environment, also turned out to be an excellent opportunity for teachers to engage in common activities between school and university; to identify together the most difficult topics in the teaching and learning of science and to develop an intervention program to target some of these difficulties; to define the minimum curriculum to get admission into the different university faculties; and to develop adequate didactic approaches. All of this resulted in a process of continuum updating for the participating teachers. The Italian school reform (known as Riforma Gelmini), which started in the academic year 2010-2011, requires the integrated teaching of Biology, Chemistry, Earth Science, and Physics. This is not only to avoid fragmentation of knowledge, but in particular to allow the students to understand the complexity of the natural phenomena. The integration of these disciplines however represents a difficult task for the teachers, who have to learn not how to teach a new subject but rather a new way to teach these same subjects. A different methodological approach is necessary to this end, and therefore taking advantage of the Plan's opportunity to work in a team composed of teachers with different backgrounds, we developed an activity that presents in an integrated way some basic topics in Chemistry, Biology, and Earth Science using a laboratory-based teaching approach.

### General aims and didactic topics

The present work was developed in order to:

- ✓ update the teaching of Chemistry to promote and strengthen its learning, by presenting its actual and everyday aspects
- ✓ enable teachers develop didactic units independently and to promote the experimental method through the learning-by-doing approach
- ✓ facilitate the integration of Chemistry, Biology, and Earth Science to overcome the fragmentation of their teaching

- ✓ help students reach an informed decision about their future University choices by making them more aware of their personal preferences
- ✓ reward talent and merit in learning scientific and technological disciplines
- ✓ work safely in the lab, using also low cost and every-day stuff

The following topics have been addressed:

- How gas performs
- Gas solubility
- Acid-base reactions and titration
- Buffering solutions
- Red-ox reactions
- Dissolution and precipitation
- Limestone and karsts
- Cell respiration, photosynthesis and fermentation
- Bacteria and bio-mineralization
- Effects of increasing-level of CO<sub>2</sub> on the environment

### Methodology and working tools

The project was developed in three phases:

1. During the first phase the teachers discussed the project and made bibliographical research to select the most significant experiments. Then they carried them out themselves structuring them according to the students' background. The teachers developed work-sheets for practical activities and PowerPoint presentations for the didactic units.
2. During the second phase the didactic units were described to the students. They were shown several stimulating images and using a brain-storming approach, they were asked to talk about their own ideas about presence of CO<sub>2</sub> in nature, with the final aim of describing the processes in which it is actually involved (Fig.1). The selected experiments were completed by the students in the laboratories at their own schools and/or at the Department of Chemistry at the University of Cagliari.



**Figure 1** One of the pictures used for brain storming about CO<sub>2</sub> in the environment (*Cala Goloritzè, Sardinia*)

3. The third phase consisted in the students reprocessing the material and drawing up the final reports. These have been used to evaluate the successful achievement of the learning objectives. The research and bibliographical search carried out by the teachers resulted in an important working tool to implement practical activities for each field and to improve knowledge on several topics. Among the most important: density and solubility of CO<sub>2</sub>; the CO<sub>3</sub><sup>2-</sup>/HCO<sub>3</sub><sup>-</sup> equilibrium in the formation and development of karsts; the relationship between dissolved CO<sub>2</sub> and ocean water acidity and its impact on the calcareous shell of molluscs' development [4-5]; buffering effect of carbonic acid in the blood [6]; red-ox reactions with CO<sub>2</sub>.

The following experimental activities were selected and performed:

- Production of CO<sub>2</sub> with various method (by burning coal, with vinegar and baking soda, by alcoholic fermentation, by breathing)
- Identification of CO<sub>2</sub> by bubbling the gas into limewater
- Measurement of CO<sub>2</sub> density and other pure gas or mixture, such as air [7]
- study of CO<sub>2</sub> solubility and acid-base equilibrium in aqueous solutions [8-9-10]
- simulation of geochemical processes involved into karsts
- experimentation of red-ox reaction with magnesium metal and solid CO<sub>2</sub> [11]
- study of CO<sub>2</sub> exchange between organisms (aquatic plants and snails) and the environment [12]
- growth and observation of bacteria involved in bio-mineralization [13]

The course was highly interdisciplinary and the laboratory-based approach provided with the opportunity to study complex systems, such as biochemical- and geochemical- ones, using ways that are appealing to the students (Fig. 2). Problem solving and cooperative learning were among the teaching methods used to reach the learning objectives. These allowed the students to acquire theoretical concepts not easily learned through more traditional teaching approaches. An experience of peer education made the students more conscious and responsible of their own learning process (Fig. 3). Finally some students read the short story “Carbonio” from “Il sistema periodico” by Primo Levi, which describes the fantastic but nonetheless realistic journey of a carbon atom [14].



**Figure 2** Experiments on photosynthesis



**Figure 3** Precipitation of CaCO<sub>3</sub> in limewater from CO<sub>2</sub> by alcoholic fermentation showed to children during a peer-education event

### Participants, location and timing

The authors and a few other teachers carried out their research at the Department of Chemistry of the University of Cagliari for a total of 60 hours. A total of 27 teachers from 13 high schools implemented the final didactic path with their students at the University and at their own schools using between 20 and 30 curricular and extracurricular hours. Local meetings with University team were organised for those students who attended schools far away from Cagliari. A total of 251 students participated in this activity.

### Results and conclusions

The collaboration between teachers from different university curricula resulted in mutual enrichment by sharing experiences and in improvement of the participants' expertise. Each teacher adapted the activities depending on the specific curriculum of their students. The students showed a great interest for this initiative which granted them the opportunity to deepen their knowledge and competence in the scientific

field, to get closer to the university world, and to realize how important chemistry is in understanding many phenomena in the world (Fig. 4).



**Figure 4** Students showing great enjoyment in experimenting the carbon-dioxide fountain

### Acknowledgments

The authors wish to express their appreciation to the Italian Ministry for Education and University for their financial support. A special thanks to Prof.ssa Antonella Rossi, responsible for the PLS-Chimica in Sardinia, and the staff of the Department of Chemistry working for the plan.

### References

- [1] <http://www.progettolaureescientifiche.eu/il-piano-lauree-scientifiche>
- [2] <http://www.unica.it/pls/index.html>
- [3] [http://archivio.pubblica.istruzione.it/riforma\\_superiori/nuovesuperiori/index.html](http://archivio.pubblica.istruzione.it/riforma_superiori/nuovesuperiori/index.html)
- [4] <http://www.who.edu/oceanus/viewArticle.do?id=52990>
- [5] [http://www.carboeurope.org/education/CS\\_Materials/seawater\\_pH.pdf](http://www.carboeurope.org/education/CS_Materials/seawater_pH.pdf)
- [6] <http://www.chemistry.wustl.edu/~edudev/LabTutorials/Buffer/Buffer.html>
- [7] F. Mannarino: La densità dei gas. In: F. Mannarino, Esperienze per il laboratorio di Chimica, pp 46-47. Ed. Mannarino, Brescia 2006.
- [8] M. Rogers: The solubility of gases. In: Gas Syringe Experiments, pp 81-83. Heinemann Educational Books Ltd, London 1970.
- [9] [http://mattson.creighton.edu/Download\\_Folder/MattsonGasBook4thEdCO2.pdf](http://mattson.creighton.edu/Download_Folder/MattsonGasBook4thEdCO2.pdf)
- [10] Seong-Joo Kang, Eun-Hee Ryu, Carbon Dioxide Fountain, J. Chem. Educ., 2007, 84, 1671-1672
- [11] <http://www.ilpi.com/genchem/demo/co2mg/index.html#demo#demo>
- [12] <http://www.woodrow.org/teachers/esi/1999/princeton/projects/cyanopigs/snail.html>
- [13] B. Perito, G. Mastromei, La carbonatogenesi batterica nella conservazione di opere d'arte, Biotec, 2000, 4, 30-37
- [14] P. Levi: Carbonio. In: P. Levi, Il sistema periodico, pp 229-238. Einaudi, Torino, 2002, X ed.

## The Secondary chemistry teaching in Brasil

Agustina R. ECHEVERRÍA, Nyuara DA SILVA MESQUITA, Márlon H. F. B. SOARES

Universidade Federal de Goiás - Instituto de Química. CP 131. CEP: 74001-970 – Goiânia – GO – Brasil  
agustina@quimica.ufg.br

### Abstract

*There is no doubt about the importance of Chemistry in current technological society. As a central science in technological processes, the chemistry level development is a fundamental indicative of a country economic relations. At the same time, and paradoxically, its study by new generations has become increasingly devoid of meaning. In Brazil the problems of chemistry teaching, pointed out by numerous researchers, are varied in nature, among them: (i) political and economic issues that determine how small is invested in education; (ii) lack of own goals; (iii) inadequate content selection; (iv) misguided visions of science in educational processes, and very especially; (v) issues associated to teacher training and related to the quality of educational aspects in initial training courses and to the necessary quantity to meet the country's demands. In addition to the problems mentioned, exists in Brazil a community of researchers in Chemical Education for nearly 40 years that has been strengthening this scientific research field with the political commitment to a relevant chemistry teaching to students and to the country. This community has created specific forums of socialization and validation of scientific production, producing quality instructional material and developing educational projects and publishing books and periodicals. This article intends to expose these chemistry teaching specificities in secondary school in Brazil in order to contribute to the improvement of teaching in the context of the country educational policy.*

**Key words:** Chemistry Teaching, Secondary Education, Teacher Training.

### The teaching of chemistry in secondary education in Brazil

When speaking in high school chemistry teaching in Brazil it is important, in the first place, to situate the education in a wide context of social-political character which, historically, shows: 1) lack of investment in education which can be seen poor physical conditions of the schools (lack of adequate laboratories and libraries), 2) the non valorization of teaching reflected in basic education teachers low wages (the high school teachers monthly wage is US \$ 690.00) and yet there are many Brazilian States that do not fulfil this determination claiming lack of budgetary resources), 3) the non valorization of teacher training courses in the universities themselves. It is important to highlight that by the law named Diretrizes e Bases da Educação Nacional-LDB, 1996 [1], the high school teachers should be trained in universities or colleges. This means, for example, that in the same university/college course can be trained professionals for the technical area, academic research and to be teachers. The teachers usually are the less valued by their colleagues, 4) the lack of own goals given by the conditions of this level of education. Here it is worth to emphasize that less than 50% of young people between 13 and 17 years in Brazil is in high school [7].

Specifically about the chemical contents, the programs have been characterized by excess contents and classifications, which promotes the memorization and the repetition of exercises that contribute little to the understanding of the phenomena and the cognitive/intellectual development of students. At the same time a naive vision of science not linked to political, ethical e environmental issues is transmitted, which leads to a decontextualised education and the experimentation, when it happens, is merely illustrative.

Which chemistry teaching is advocated in this article? Aware of the central role of chemical science in contemporary society, we advocate the study of this knowledge field in high school, as part of a school that needs to break up with the situation so far presented. We advocate in favor of a chemistry education

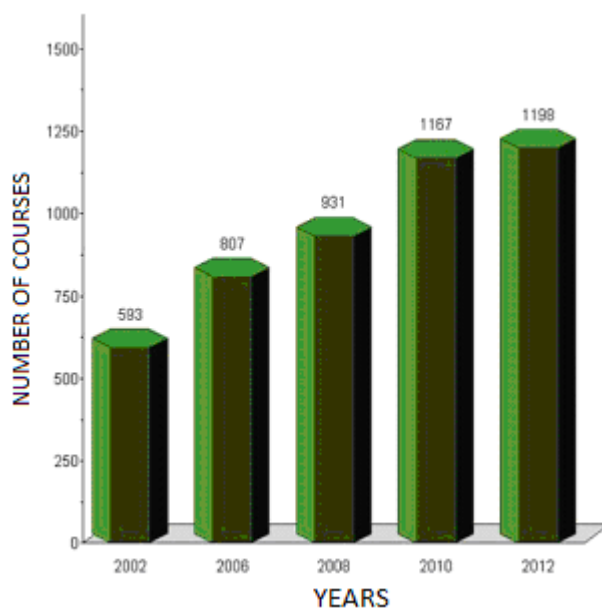
that contributes to a wide students training, which allows the insertion of this students in the world of work in a critical and participatory way and also enables further studies. Within the framework of these objectives it is necessary to understand the development of the chemistry teaching in Brazil. Chemistry appears in the secondary education curriculum in Brazil in 1925 and until the 1970 decade it had a descriptive and “memorized” character. Only in the late 1970 some researchers began to discuss the teaching of chemistry, it appears the first papers and it began to form a new field of knowledge in the country: the research in Didactics of the Sciences [2].

In 1982 it took place at the University of Campinas (UNICAMP), the first national meeting of chemistry teaching (ENEQ). Since then this event brings together, every two years, teachers, researchers, graduate and undergraduate students. In 1988 it was created the Educational Division of the Brazilian Chemical Society (SBQ) and in 1999 the National Curricular Parameters for High School (PCN) was elaborated. This PCN synthesized the educators community discussions and proposals. Nevertheless there is another aspect that needs to be pointed out: there is a particular problem in Brazil which is the teachers training. Unlike many Hispanic American countries and for reasons linked to the history of education in the country, specifically the history of Brazilian universities, the first teacher training courses was created late in the 1930 and until 1965 there were only 13 training courses for Chemistry teachers [3].

In the 1970 Decade, to solve this problem, the Federal Government created short courses that were criticized by the academic community. The 1980s was a Decade full of criticism and within the 1996 LDB it was instituted for the first time in Brazil's history the training of high school teachers in undergraduate courses, namely at the universities. The LDB requires full training at a undergraduate course level to the exercise of teaching profession at the high school level and because of this, since 1996 the number of teaching training courses has increased by 10 to 12 times, but until this moment the law can not be accomplished and there is a deficit of more than 200,000 Science (Chemistry, Physics, Biology) teachers in Brazil. In the State of Goiás, which is where the authors of this article work, only 15% of teachers who teach Chemistry classes, are trained in Chemistry [4].

It is important to say that because of the really low salaries even if the numbers of training teacher courses increases, when the teachers are formed they seek other activities more attractive than teaching.

From 2007/2008 onwards, the Federal university network was expanded through the Program for the Restructuring and Expanding of Federal Universities (REUNI). By 2012 it aimed to provide 267 more teacher formation courses than in 2008, as can be seen in Figure 1.



**Figure 1** – REUNI - Proposals for the Expansion of teacher training courses Source: [http://reuni.mec.gov.br/index.php?option=com\\_content&task=view&id=148&Itemid=8](http://reuni.mec.gov.br/index.php?option=com_content&task=view&id=148&Itemid=8)

In this respect, Federal Government Decree 3.462/00 encouraged the Federal Centers for Technological Education, now Federal Institutes of Education, Science and Technology (IF), to set up teacher formation courses [5]. In addition, the December 29, 2008, Law 11892 decreed that 20% of the courses set up by these institutions had to focus on teacher formation [6].

This Official decision was and remains questioned by the academic community which argues against it stating that the IF have no historic tradition in the training of teachers.

### **Concluding remarks**

What is the current real situation in Brazil? It is possible to say that there is a community of chemists researchers/educators qualified and consolidated for more than 30 years of educational research, but it is importante to admit that the results of the surveys don't always come to the classroom neither materialize in public policy. It is also important to note that in recent years, there has been an expansion of teacher training courses. However government investment in education and teachers salaries remain low. In this way, and as pointed out at the beginning of this article, the chemistry teaching in Brazil can only be thought and questioned in the context of its complexity that involves historical, political, economical, cultural, epistemological and pedagogical aspects, among others.

### **Acknowledgments**

Research Foundation of Goiás State (FAPEG)  
Universidade Federal de Goiás (UFG)

### **References**

1. BRASIL; Lei de Diretrizes e Bases da Educação Nacional. Lei nº 9394 de 20 de dezembro de 1996.
2. SCHNETZLER, R. P. A pesquisa em ensino de química no Brasil: conquistas e perspectivas. *Química Nova*, 2002, n. 25, p. 14 - 24.
3. MESQUITA, N. A. S.; SOARES, M. H. F. B. Aspectos históricos dos cursos de Licenciatura em Química no Brasil nas décadas de 1930 a 1980. *Química Nova*, 2011, v. 34, p. 165-174.
4. DAMASCENO, D. ; GODINHO, Mariana da Silva ; SOARES, M. H. F. B. ; OLIVEIRA, Anselmo Elcana de . O Perfil da Carreira dos Docentes de Química da Rede de Ensino Pública do Estado de Goiás, Brasil: Uma Análise Multivariada. *Educación Química*, 2010, v. 21, p. 246-253.
5. BRASIL; Decreto nº 3.462, de 17 de Maio de 2000.
6. BRASIL, Lei nº 11892 de 29 de Dezembro de 2008.
7. BRASIL, 2009. Pesquisa Nacional por Amostra de Domicílios - PNAD/IBGE.



## Student Active Learning in Science (SALiS) The theoretical and organisational framework of a TEMPUS IV project

Ingo EILKS\* and Marika KAPANADZE\*\*

*\*University of Bremen, Germany; \*\*Ilia State University Tbilisi, Georgia*

*\*University of Bremen, Dep. of Biology and Chemistry, Leobener Str. NW 2, 28334 Bremen, Germany, ingo.eilks@uni-bremen.de, +49 421 218-63280/8*

### Abstract

*Educational theory suggests that learning science follows the theory of social constructivism. This theory asks for organizing the teaching-learning-process in a student-active mode to be characterized by high individual as well as collaborative and cooperative student activity. This paper sums up essential tenets from this theoretical justification for more student-active learning in science. It discusses different dimensions of making the student more active in the science classroom as a theoretical underpinning of the EU-project TEMPUS-SALiS. The framework of the project will be presented.*

**Keywords:** Science Education, Constructivism, IBSE, Active Learning, EU-projects, SALiS

### 1 Justifying more Student Active Learning in Science

Science teaching in many classrooms all over the world can still be characterized as being a teacher-centred approach. The teacher is presenting the content while the students are passive and thought to absorb the information showered on them by the teacher. If laboratory work is embedded at all, it is very much often limited to the teacher demonstrating experiments. Interaction with and among the students is limited to short periods of guided questions and short answers. As a result, we all too often find out that what we had taught and what our students had actually learned are very different. The most often reaction by the teacher is to try to explain better. The teachers hope that the better they will present the content the better their students will learn [1]. This interpretation of learning is not in line with what educational theory suggests, e.g. [2]. Educational theory suggests that, knowledge cannot be transferred intact from the mind of one person into the mind of another. Learning with meaning and understanding only takes place if the learning becomes an activity within the mind of each individual learner [3]. Meaningful learning is the active integration of new information with knowledge already possessed by the learner. The subsequent interpretation of this new information will then depend heavily on what the learner already knows and what cognitive processes will occur in the mind of the learner. This means that the quality of education should not be assessed in terms of the effort being put in by the teacher. The quality – and quantity - of learning is much more dependent on the effort being put in by the learner.

Today, our understanding of effective science learning is generally referred to the theory of constructivism [2]. Constructivism suggests applying teaching methods making the learner the active player and to encourage the learner to become cognitively engaged in developing understanding of the topic being taught. The more elaborated interpretations of constructivism not only seek to make students active thinkers, but to promote interaction and collaboration between them. The socio-constructivist framework suggests learning in interpersonal communication and social interaction as being essential for any effective learning [4]. Socio-constructivism explains that effective learning requires a process that mainly functions through cultural and social mediation about content [5,6].

From these theories, we know that science education should apply methods fostering activity in the students' contemplation with the content and also make science education a collaborative and cooperative practice. Instead of studying the mental content of individual minds, collaborative and cooperative learning focuses on the processes of interaction, participation, discourse, and negotiation. Cooperative learning leads to co-constructing knowledge and to building up collaborative knowledge where the group

is able to attain a level of understanding that could not have been achieved through the mental processing of any one individual from within the group alone [7]. This is true for the learning of pure subject matter knowledge as well as the learning within contexts or learning via practical work. If all the different dimensions of making the student active – hands-on and minds-on – are used in science education, the classroom environment has high potential for effective learning, student motivation, and the development of skills beyond the rote learning of subject matter knowledge. More general educational skills will be promoted including inquiry skills, organising and structuring of projects, or team working abilities. In the result higher cognitive achievement, better development of higher-level thinking skills, increased student self-confidence and satisfaction and better attitudes towards subject matter will be the result [6].

## 2 Dimensions of Making the Science Classroom Student-active

Considering the theoretical framework briefly discussed above (see also [8]), we can allocate different domains where more student activity in the classroom will lead to more effective science learning.

*Activating students' prior knowledge.* One of the first assumptions of constructivist learning theory was that learning depends on the learner's prior knowledge and interest. Neglecting students' prior knowledge and interests will lead to diminishing motivation and will limit learning to rote memorization. The result will be memorization of isolated facts detached from their scientific origin and potential contexts of application leading to inert knowledge with no chance to be applied. Putting the content into a context connected to the students' prior knowledge and interests is essential for effective learning. The prior-knowledge should be activated and associations a student might have with the topic should be made explicit. Making prior-concepts explicit and making students aware about the potential discrepancy between their prior-conceptions and scientific explanations can be used to motivate contention with science learning [9].

*Activating students' minds.* Learning science, beyond cold memorization of facts and theories, is never a passive diffusion of knowledge. Only actively constructed knowledge has chance to become applicable knowledge, transferrable to new situations. If new information is presented challenging the prior understanding of the learner cognition will be accommodated, resulting to new knowledge. Therefore, science education should try to activate the students' minds by challenging them in a cognitive conflict in the learner. New information should contradict and challenge prior conceptions that might be not scientifically reliable. Tasks shall be used to challenge students' thinking and guide the learning in an inquiry-based mode, especially in connection to the learning in the laboratory [10].

*Activating hands.* Learning can make use of more channels than only the acoustic and visual channel. The more senses are activated the better is the chance for learning. Student-active learning should include hands-on student activity. Students' practical work is a unique chance to raise motivation and learning effectiveness [10]. Microscale- and low-cost-techniques can help making students' laboratory work available even with low budgets and bad equipment [11]. However, also other physical and social activities should be embedded into the science classroom, e.g. working with physical models, using ICT, or operating drama and role play [12].

*Activating cooperation.* Cooperative learning proofed to offer a whole range of strategies for effective and motivating learning in science by promoting student-student-cooperation. Student-active science learning asks for applying cooperative learning with positive interdependence of the learners instead of the teacher-centered approach or traditional, unstructured group work [12]. Promising examples are e.g. the Jigsaw Classroom [13] or the Learning Company Approach [14].

*Activating communication.* In the heart of social constructivism is also the idea that learning is meaning making in communication to others, preferably not only the teacher. Communication and negotiation between the learners provoke meaning making and shaping of concepts in their minds. Student-active learning in science should provoke various forms of communication. It asks for multi-directional forms of communication. Pedagogies like the 1-2-4-All method can help students to organize meaning making by negotiation and cumulative communication [15]; methods like the ball bearing can help to train communication and operate reciprocal teaching [16].

### 3 TEMPUS-SALiS – The Organisational Framework

All the above discussed theories promise to make science education more motivating, more effective in subject matter learning and to raise its potential for the promotion of a broad range of cognitive and non-cognitive skills. Unfortunately, classroom practice in many countries of the world still seems to be dominated by a teacher-centered teaching paradigm with low student-activity in minds and hands. That is why within the cooperation of the Ilia State University in Tbilisi, Georgia, and the University of Bremen, Germany, the project initiative ‘SALiS - Student Active Learning in Science’ was launched in 2009. Together with further 10 partners from Bulgaria, Germany, Georgia, Ireland, Israel, and Moldova, an application for a reform network was submitted to the TEMPUS program of the European Union. The project was successfully approved in summer 2010 and was conducted from 2010 to 2012. The budget was approx. 800.000 €.

SALiS aimed at promoting science teaching through a better inclusion of student-active and inquiry-based experimental learning in science classes. The project intended to promote i.e. inquiry-type lab-work as one of the foundations of modern science curricula and pedagogies to raise motivation, support development of higher order cognitive skills, a better learning of science concepts, and to promote a broad range of general educational skills.

Recognizing that the teachers are the core for any innovation in educational settings, the project aimed at innovating science teaching in the above mentioned sense by improving teacher training. For the purpose described, all participating institutions jointly developed curricula and materials for science teacher training. These curricula and materials enabled pre- and in-service science teachers to strengthen hands-and minds-on student learning through innovative approaches to lab-work instruction, e.g. inquiry-type strategies, open lab tasks, or cooperative learning in the lab environment. Additionally, respective infrastructure was installed in the participating universities from Georgia, Moldova and Israel. In the two years of SALiS several outcomes were reached:

- The SALiS consortium jointly developed teacher training modules, school teaching materials, and a concept of implementation of SALiS via the use of low-cost lab equipment.
- We collected and disseminated good practices from all partner countries and made them available to the other partners by translation and adoption.
- A lab guide for low-cost- and microscale-experimentation in science education was developed and translated in seven languages. A database of more than 150 experiments in different languages for low-cost- and microscale-experimentation was made available via the SALiS website ([www.salislab.org](http://www.salislab.org)).
- SALiS strengthened the science education infrastructure in the six beneficiary institutions through equipping science teacher training laboratories including guides that describe the usage of such laboratories in teacher training including questions of safety, logistics and maintenance issues.
- The project created the foundation for upgrading science education in many schools in the beneficiary countries by the training of science teachers. Qualification of staff for in- and pre-service teacher training concerning the SALiS philosophy took place, experiences were shared during visits and placements between the partner institutions. Through a thorough implementation of the SALiS training modules and the staff training in all partner institutions the dissemination became broad and sustainable.
- Although the essential components and facilities of SALiS are available in all the EU partner institutions, the whole process also led to an improvement in the teaching skills and available training modules in the EU partner institutions.

Further information can be obtained via the SALiS website: [www.salislab.org](http://www.salislab.org).

### Acknowledgement

*We gratefully acknowledge the funding by the TEMPUS program of the EU, ##511275-TEMPUS-1-2010-1-GE-TEMPUS-JCPR (Agreement,2010-33821/001-001)*

## References

1. B. Byers, I. Eilks, The need for innovation in higher chemistry education – A pedagogical justification. In I. Eilks & B. Byers (eds.) *Innovative methods for teaching and learning chemistry in higher education*, pp. 5-22, RSC Publishing, London, 2009.
2. G. M. Bodner, *J. Chem. Educ.*, 1986, 63, 873.
3. M.C. Wittrock, *Educ. Psych.*, 1989, 24, 325.
4. D. Hodson, J. Hodson, *Sch. Sci. Rev.*, 1998, 79 (289), 33.
5. R. Driver, V. Oldham, *Stud. Sci. Educ.*, 1986, 13, 22.
6. R. Lazarowitz, R. Hertz-Lazarowitz: Co-operative learning in the science curriculum. In B. J. Fraser & K. G. Tobin (eds.) *International handbook of science education*, pp. 449-470, Kluwer, Dordrecht, 1998.
7. D. W. Johnson, R. T. Johnson, *Learning together and alone: Cooperative, competitive, and individualistic learning*, Allyn & Bacon, Boston, 1999.
8. I. Eilks, *Chem. in Action*, 2012 in print.
9. O. De Jong, R. Blonder, J. Oversby: How to balance chemistry education between observing phenomena and thinking in models. In I. Eilks & A. Hofstein (eds.), *Teaching chemistry– A studybook*, Sense, Rotterdam in print
10. A. Hofstein, M. Kipnis, I. Abrahams: How to learn in from the chemistry laboratory. In I. Eilks & A. Hofstein (eds.), *Teaching chemistry– A studybook*, Sense, Rotterdam in print.
11. N. Poppe, S. Markic, I. Eilks, *Low-Cost-lab techniques for the science classroom*, SALiS Project, Bremen, 2011.
12. I. Eilks, G. T. Prins, R. Lazarowitz: How to organize the classroom in a student-active mode. In I. Eilks & A. Hofstein (eds.), *Teaching chemistry– A studybook*, Sense, Rotterdam in print
13. I. Eilks, *J. Chem. Educ.*, 2005, 82, 313.
14. T. Witteck, I. Eilks, *Sch. Sci. Rev.*, 2006, 88 (323), 95.
15. T. Witteck, I. Eilks, *Sch. Sci. Rev.*, 2005, 86 (317), 107.
16. T. Witteck, B. Most, G. Leerhoff, I. Eilks, *Sci. Educ. Int.*, 2004, 15, 209.

## Japan-Korea Cooperative Lesson on the Topic of Bio-diesel in Chemical Education: Focus on Promotion of Students' Abilities in Proper Judgment

Hiroki FUJII<sup>1\*</sup>, Eri SHIOZAKI<sup>1</sup>, Atsushi HIRAMATSU<sup>2</sup>, Yusuke OHGATA<sup>2</sup>,  
Ryoichi UTSUMI<sup>2</sup>, Sung Hoon KIM<sup>3</sup>, Haruo OGAWA<sup>4</sup>

<sup>1</sup> Department of Science Education, Graduate School of Education, Okayama University,  
3-1-1 Tsushimanaka, Kita-ku, Okayama 700-8530, Japan

<sup>2</sup> Hiroshima University High School, 1-1-1 Midori, Minami-ku, Hiroshima 734-0005, Japan

<sup>3</sup> Cheonan Jungang High School, 460-1 Wonseong-dong, Dongnam-gu, Cheonan-si, Chungcheongnam-do 330-070, Korea

<sup>4</sup> Department of Chemistry, Faculty of Education, Tokyo Gakugei University, 4-1-1 Nukuikitamachi, Koganei,  
Tokyo 184-8501, Japan

e-mail: fujii-hi@cc.okayama-u.ac.jp

### Abstract

A lesson model of high school chemistry on the topic of bio-diesel was developed through a Japan - Korea joint research. By applying student's knowledge on science, the model is aimed at promoting their ability to judge social problems about energy supply.

Contents of the lesson are composed of the following, (1) Lecture: "Energy situation and development of bio-energy/bio-diesel", (2) Experiment: "Generation of bio-diesel" and "Comparison of bio-diesel and diesel as a chemical", and (3) Group discussion: "Evaluation about bio-diesel and diesel as a fuel from the standpoint of energy" and "Planning for the utilization of bio-diesel".

Results of the evaluation on trials conducted have shown that the lesson model was able to promote student's abilities to judge social problems related to energy supply not only on the standpoints of environment, economy, and society but also on the aspects of science and technology. Moreover, trials have indicated significant relations between student's ability in judgment and acquired knowledge of science related properties of bio-energy and bio-diesel.

**Keywords:** high school chemistry, ability in judgment, lesson model, bio-energy, bio-diesel

### 1. Introduction

The promotion of student's ability to judge social problems is one of the recent research and practice concerns in science education since e.g. developments of teaching and learning materials like *ChemCom* [1] and *Salter's Advanced Chemistry* [2]. The current researches are progressed theme on Socio-Scientific Issue [3]. However, very few researches are done in the context of Japanese and Korean science education for promoting student's judgment ability. Therefore, neither proper contents of lesson nor effective teaching strategy for promoting student's ability in judgment in high school chemistry is shown.

On the other hand, the utilization of bio-energy as a renewable energy is one of recent social issues in Japan and Korea. Bio-diesel as a kind of bio-energy is an alternative diesel fuel. And still, the students do not entirely understand things about bio-energy and bio-diesel with satisfaction, and they are lacking in ability to judge social problems related to energy.

A lesson model of high school chemistry on the topic of bio-diesel is proposed herein with the aim at promoting student's ability to judge social problems about energy supply. An assumption that would influence the acquired knowledge concerning bio-diesel toward the ability in judgment is assessed through this study.

## 2. Development of the lesson model

The aim of making a lesson model is to promote the student's ability to judge social problems about energy supply by applying their knowledge of science through an improved model of the Berlin analogue developed by Bolte, C. et al. [4] [5]. Contents of the lesson are composed of the following items.

- Lecture (60 min.): "Energy situation and development of bio-energy/bio-diesel"
- Experiment (180 min.): "Generation of bio-diesel" and "Comparison of bio-diesel and diesel as a chemical"
- Group discussion (90 min.): "Evaluation about bio-diesel and diesel as a fuel from the standpoint of energy" and "Planning for the utilization of bio-diesel"

Materials for the lecture, a manual and worksheets for the experiments, and evaluation sheets for the group discussions were developed and introduced. These instructional materials mentioned were modifications based from the original Berlin model. Contents from Japanese and Korean school textbooks were incorporated into the materials and manual to serve as supplement as well as to facilitate easy use for Japanese and Korean students. Worksheets and evaluation sheets were followed completely as outlined in the Berlin model.

## 3. Trial of the lesson model

The lesson model was carried out with 21 Japanese students (Hiroshima University High School) and 19 Korean students (Cheonan Jungang High School), both in 11<sup>th</sup> grade, from January 12<sup>th</sup> through 13<sup>th</sup>, 2011. Both group of students were asked to answer the 22 science questions selected from TIMSS (Trends in International Mathematics and Science Survey) before the actual lesson started. When the score rate average of both of students was calculated, t-test was given to the average with p-value of 0.165 point ( $p > 0.1$ ). It was shown that there was not necessarily significant difference in terms of the academic achievement between both groups of students. Therefore, these students can be considered as appropriate research tool for a comparative study.

**Lecture;** The lecture covers the topic on energy consumption of the world, including Japan and Korea; dependence on fossil fuels, reserves and price of crude oil, amounts of the CO<sub>2</sub> exhaust, and the latest trend on the development of renewable energy in the world and bio-energy, especially bio-diesel. Moreover, the lecture on materials about oils, fats, and fatty acids and the generation of bio-diesel by transesterification of colza oil with methanol were presented to the students.

**Experiment;** The student's activities in this part include generation of bio-diesel and measurement of calorific values, viscosities, and flash points among colza oil, bio-diesel, and diesel. The comparison of bio-diesel and diesel as a chemical were also conducted.

**Group Discussion;** Bio-diesel and diesel were evaluated as a fuel from the standpoint of energy. Moreover, the students discussed the plan on the utilization of bio-diesel for a certain town. Discussion was focused mainly on both the advantages and disadvantages of bio-diesel for the promotion of bio-energy as students took the role as consumers themselves.

## 4. Evaluation of the lesson model

### 4.1 Ability in judgment

Questionnaires were given to the students before and after the lesson. Reasons for agreeing with or opposing on the construction of facilities of energy supply like fossil fuel, wood, bio-diesel, biogas, force of the wind, solar battery, and nuclear power were enumerated. The number of the reasons showed an increase of about 1.5 times per a student after the lesson (Figure 1). Specifically, after the lesson on facilities of energy supply using the bio-diesel was discussed, the number of reasons has increased about 1.8 times for Japanese students and 1.9 times for Korean students.

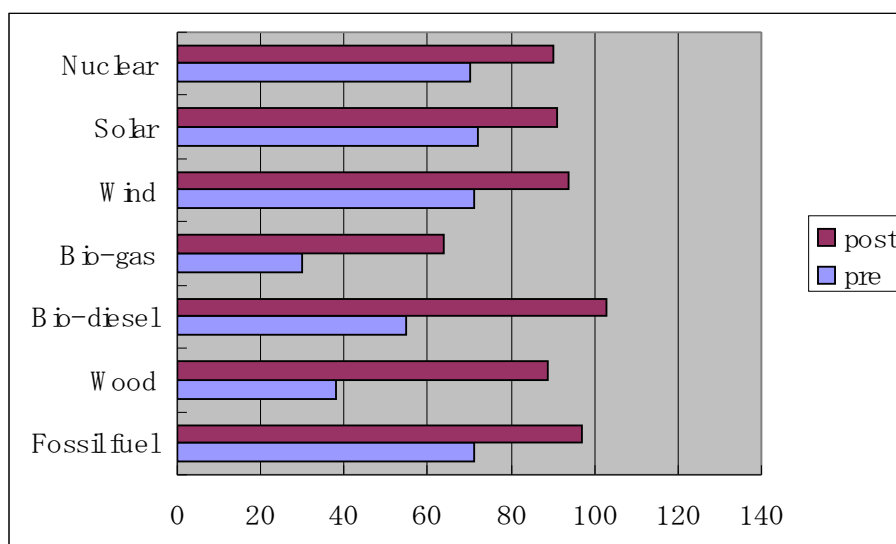


Figure 1

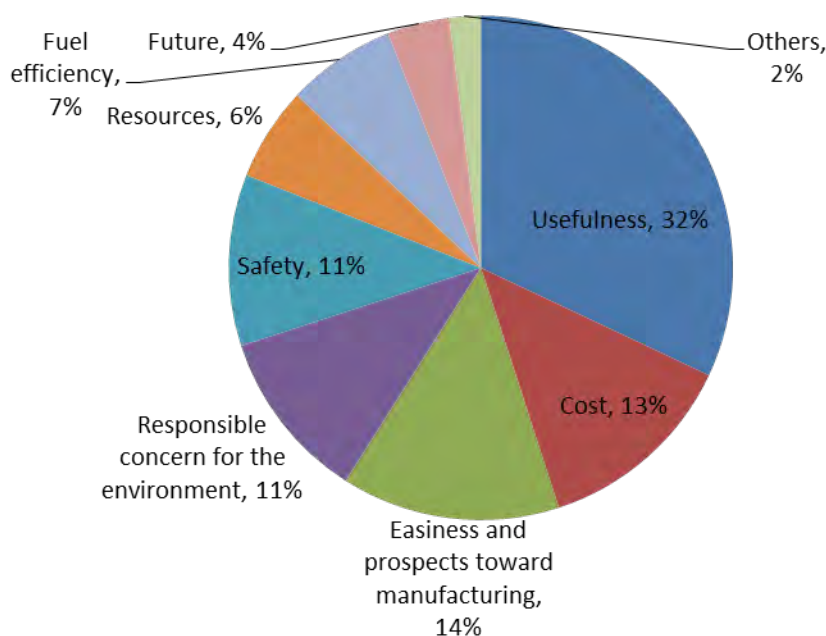


Figure 2

The nature of the reasons was varied (Figure 2). For instance, not only the aspect about ecology was identified but also reasons related to the aspects of science (chemistry) and technology. These reasons had increased after the lesson. Moreover, the sustainability of these aspects also appeared significantly.

Another questionnaire was given to the students after the lesson. Since “bio-diesel vs. diesel” as a fuel were assessed as outlined: “Write down ten criteria which are important for your assessment of both kinds of fuel, i.e. bio-diesel and diesel”, various criteria from the standpoints of the usefulness, the cost, easiness and prospects toward manufacturing, the responsible concern for the environment, fuel efficiency, *etc.* were raised to the surface (Figure 3). For each grade, these materials as a fuel were determined by the following rule to score the given standpoints.

- Choose five from the ten criteria that you want to use for the assessment. Determine the importance or the weighting factor of each criterion by allocating all in all 20 points to the chosen criteria.
- Assess bio-diesel after criterion and allocate grades to it (5 = very good to 1 = inadequate).
- Calculate the weighted grades by multiplying the grade of the respective criterion with the weighting

- factor. Then add the single weighted grades. In order to calculate the “final grade”, divide the sum of the weighted grades by 20.

- In order to assess diesel, use the same rule as that of the bio-diesel fuel.

The average of the “final grade” in Japanese students was 3.3 of bio-diesel vs.2.7 of diesel and that in Korean students was 3.5 of bio-diesel vs.2.7 of diesel. Bio-diesel clearly showed a higher assessment.

Moreover, the students discussed the plan on the utilization of bio-diesel in a certain town as an example. Their sketches of the planning based on the discussion were indicative of various standpoints such as the environment, the economy, the technology, and the sustainable community. For instance, a Japanese girl student who was conscious of the environment in the town paid attention to the cooperation between agriculture and the utilization of bio-diesel. She described as following: *“The people cultivate a corn and extract the oil. After the extraction, the dregs of a corn are also used as feedings of livestock, and then the dung of livestock is used as fertilizer of corn. The people should make such a cycle to develop an ecological town which doesn't produce waste.”*

#### 4.2 Acquired knowledge

The acquired knowledge is evaluated through the Concept Map drawn by category of knowledge and forming networks of knowledge, e.g. *“Bio-energy → Biomass → Utilization of waste → Waste treatment → Reduction of CO<sub>2</sub> exhaust”* and *“Bio-diesel → Vegetable oil → Plant → CO<sub>2</sub> → Environment → Carbon neutral”*.

#### 4.3 Relations between ability in judgment and acquired knowledge

About the relation between judgment and the acquired knowledge, eight students who formed the practical plan on the utilization of biodiesel from comparatively various viewpoints were taken up. They each mentioned common words as like “environment” and “newness” in their response such as in the sketch of the practical plan on the utilization of biodiesel, the reply to the criteria of the assessment about biodiesel and diesel, the reply about the reasons for agreeing with or opposing on the construction of facilities of energy supply, and in the concept map in which the knowledge acquired about bio-energy and bio-diesel (Table 1).

Table 1

Appearance of ability in judgment			Acquired knowledge	
	Planning for the utilization of bio-diesel	Criteria of the assessment of bio-diesel and diesel	Reasons for an agreement with or opposition to the construction of facilities of energy supply	
			Knowledge about bio-energy and bio-diesel	
Student A	The people cultivate a corn and extract the oil. After the extraction, the dregs of a corn are used for a feed of livestock, and then the dung of livestock is used for a fertilizer of corn. The people make such a cycle to develop a town which doesn't produce the waste.	<u>Environment</u> , <u>Resources(Reserves)</u> Combustibility, Efficiency, Weight, Time for manufacture, Viscosity, Easiness of manufacture, Price, Safety	Agreement: <u>Earth friendly</u> , Good efficiency, Opposition: Requirement of much time	<u>Environment</u> , Corn, Plant, Colza oil, It can be worked a car, Revitalization of a town
Student B	The people set up a filling bio-diesel station.	<u>Burden for environment</u> Easiness of production, Fuel consumption, Viscosity, Limit or not (future), Cheap	Agreement: <u>Good for environment</u> , Reduction of waste Opposition: High cost, No precedent because of the newness	<u>Good for environment</u> , New energy, Diesel, Light oil, Motorbike, Methanol solution



## 5. Closing

The lesson model related to bio-diesel in chemical education of high school was proposed. The model was able to attain the promotion of the student's ability to judge social problems related to energy supply not only on the standpoints of environment, economy, and society but also in the aspects of science and technology. At the same time, significant relations between student's ability in judgment and acquired knowledge of science related properties of bio-energy and bio-diesel have surfaced through the utilization of the model.

## References

- [1] American Chemical Society, *ChemCom. Chemistry in the Community*, Kendall/Hunt Publishing Company: Iowa, 1988.
- [2] University of York Science Education Group, *Salter's Advanced Chemistry*, Heinemann Publisher Ltd: Oxford, 1994.
- [3] Sadler, T. (Ed.), *Socio-scientific Issues in the Classroom*, Springer, 2011.
- [4] Kirschenmann, B. and Bolte, C., ParIS in Berlin: Bild Dir Deine Meinung... zum Thema Bioenergie, in: Höttecke, D. (Hg.), *Naturwissenschaftlicher Unterricht im internationalen Vergleich*, LIT Verlag: Berlin, 2006, 316-318.
- [5] Kirschenman, B. and Bolte, C., *Science in a Class of Its Own: Renewable Energy Sources –“My iPod Works with Energy from Bull Shit”*, PARSEL Consortium Teaching-Learning Materials, 2007.

## Inquiry and project-based learning about plastic and plastic waste

Petra LECHOVÁ<sup>1</sup>, Mária GANAJOVÁ<sup>2</sup>

<sup>1</sup>Gymnázium Šrobárova 1, 042 23 Košice, Slovenská republika  
petralechova@gmail.com

<sup>2</sup>Oddelenie didaktiky chémie, Prírodovedecká fakulta, Univerzita P.J. Šafárika,  
Moyzesova 11, 040 54 Košice, Slovenská republika  
maria.ganajova@upjs.sk

### Abstract

*The paper points out common features and significance of research method in project-based teaching of the topic Plastic and Plastic waste. The project-based method has been implemented as team work on a relatively broad task, its output being posters, presentations, radio presentations, displays of pupils' work, etc. Pupils have projects on such topics as it is an incineration plant to blame, To recycle or to throw away, etc. With the help of the teacher pupils suggested topics, aims of the project, common planning, implementation and presentation of results, evaluating of results, etc. Different forms of research-based method, such as the experimental part in which pupils tackled tasks focused on properties of plastic materials or the theoretical part, eg. kinds of plastic materials and their labeling, or tackling a research task focused on recycling of plastic materials, their decomposition in soil, etc. were used in project work. This kind of project-based teaching is marked with its research character. The teacher guides a pupil in a way similar to the one common in real research. The efficiency to the above methods was evaluated by means of scale-based questionnaire for project-based method as well as by ESTABLISH tools for determining the influence of IBSE on pupils' learning. Teachers pointed out possibilities of incorporating the topic into chemistry teaching as well as making it contents of an interdisciplinary topic Environmental education at basic schools.*

**Key words:** Project-based teaching, inquiry-based method, digital library, plastic and plastic waste

### Introduction

Project and inquiry-based education methods are currently ranked among main methods leading to increased efficiency of science education. In our research we focused on common features and significance of an inquiry-based method in project-based education.

Inquiry-based activities are contents project-based education because project-based education is of inquiry-research character and because inquiry or research activities of pupils within a project represent a unique educational method. By means of inquiry-based method a pupil is managed in a way similar to the one common in real research. That is from formulating hypotheses, through devising methods, obtaining results by means of the methods agreed upon by pupils and a teacher, and through discussion to conclusions. This enables a pupil in a relatively independent way and in co-operation with peers to state the problem, propose a method to solve it, look up information, resolve the problem in the agreed way and thus acquire necessary competences, knowledge, skills and communication skills in an active way[2]. Based on that we have created the digital library for project-based teaching containing inquiry-based activities. The paper informs about the demonstration of the digital library together with inquiry-based activities for the topic Plastic and Plastic Waste. The library should serve for teaching chemistry as well as interdisciplinary topics „Setting up a Project and Presentation Skills“ and „Environmental Chemistry“ of the State Educational Programme (SK) and General Educational Programme (CZ). The library should provide chemistry and other science teachers with methodological educational resources needed for setting up interdisciplinary projects such as learning texts, proposals of experiments on a particular topic, proposals for and outputs of projects as well as inquiry-based methods.

The library can be found on <http://kekule.science.upjs.sk>. It has been created partly thanks to the finance from KEGA č. 027/2011 national project. The inquiry-based activities have been prepared within Establish project.

### Digital library structure

The digital library is currently available for the following topics: Water, Natural Substances – Proteins, Saccharides, Lipids, Energy, Plastic and Plastic Waste.

The screenshot shows a web browser window displaying the digital library. At the top, a green banner reads "The digital library for project teaching in chemistry" and "KEGA 027 UPJS - 4/2011". Below this is a navigation menu on the left with buttons for: "Description of the project", "Water", "Energy and its resources", "Natural substances", "Lipids", "Fats", "Carbohydrates", and "Plastics and plastic waste" (which is highlighted). The main content area is titled "The digital library for the topic PLASTICS AND PLASTIC WASTE". It features two sections: "Didactics of the topic PLASTICS AND PLASTIC WASTE" with a bullet point: "• The topic Plastics and plastic wastes in the State education program"; and "Theoretical basis for the topic PLASTICS AND PLASTIC WASTE" with a list of bullet points: "• Characteristics of Plastics", "• Plastics and their properties", "• Plastics and the Environment" (with a sub-bullet "◦ Presentation 'Recycling of waste'"), "• Characteristics of selected recycled plastics" (with sub-bullets "◦ Macromolecular substances: [http://kekule.science.upjs.sk/chemistry/mvp\\_net/Waste/transparenties.html](http://kekule.science.upjs.sk/chemistry/mvp_net/Waste/transparenties.html)" and "◦ Glossary: [http://kekule.science.upjs.sk/chemistry/mvp\\_net/Waste/Glossary.html](http://kekule.science.upjs.sk/chemistry/mvp_net/Waste/Glossary.html)"), and "• Plastic Waste" (with a sub-bullet "◦ Presentation 'Waste'").

Figure 1: View of the digital library for the topics Plastic and Plastic Waste

For each topic the library offers the following methodological means in a digital form: learning texts, presentations, experiments, model proposals of projects, inquiry-based activities for the above topics, school radio programmes and events proposals, etc.

In the following part the library available for the topics Plastic and Plastic Waste is depicted. The methodological means of the library for the topic Plastic have the following structure:

**1. Methodology of the topic Plastic and Plastic Waste** – presents the contents and performance standards of the State Educational Programme in Slovakia for the 2nd grade of basic schools ISCED 2 and the State Educational Programme for grammar schools ISCED 3A for the topic Plastic and Plastic Waste.

**2. Studying material** – contains learning texts available for the topics: Characteristics of Plastic, Plastic Materials and Their Properties, Plastic and the Environment, Characteristics of Selected Recyclable Plastic Materials, Basic Terminology Dictionary, Plastic Waste. Presentations of teaching created by teachers in MS PowerPoint programme are also part of the library. The presentations contain selected theoretical knowledge.

**3. Experiments** – present chemical experiments such as Origin of Plastic, getting to know plastic, making glue from polystyrene waste, proof of polymers by means of a flame test.

**4. Proposal of project on the topic Plastic and Plastic Waste** – its essence lies in the following parts of the project: introduction, outlining goals and procedures, dividing theoretical and practical tasks in groups, implementation, presentation and evaluation of project findings [1].

**5. Implemented projects of pupils** – contain projects outputs, eg. PowerPoint presentations of the topics „It is Incineration Plant to Be Blamed“ , „To Recycle or to Throw away“.

**6. Inquiry-based activities** – contain activities focusing on determining properties of plastic materials, kinds of plastic materials and their labeling, recycling plastic, decomposition of plastic, etc. By means of these activities pupils study different plastic materials from their neighborhood, get to know their physical and chemical properties, design experiments, formulate hypotheses and based on the acquired experience they try to guess the use of different plastic materials in practice and look for their existing and possible use. They get to know different kinds of plastic packaging materials, learn about possible separating of plastic in collecting bins and subsequent recycling of plastic. [2].

## Testing the digital library on teachers and pupils

### Opinions of in-servis chemistry teachers on using the digital library

The digital library for the topics Plastic and Plastic Waste containing inquiry-based activities was tested on 10 basic and grammar school teachers. The teachers said the digital library containing inquiry-based activities means a useful digital aid in implementing projects and at the same time it enables pupils to:

- do projects in an independent and active way, the library offers experience-based learning,
- develop key competences – pupils learn to listen to peers' opinions, think about a topic, reason and participate in a discussion,
- actively approach learning resulting in longer-lasting acquired knowledge and increased interest in chemistry.

### Opinions of pre-servis chemistry teachers on using the digital library

Pre-service chemistry teachers studying at the Faculty of Sciences of P.J.Šafárik University in Košice thought the library was particularly useful for beginner teachers who do not have experience in project-based teaching and that is why they found guidance and examples of projects very inspiring.

### Opinions of pupils on using the digital library for self-learning

The library is an excellent self-learning aid for pupils' project work. The pupils found the available learning texts very useful because of the correct, verified information they contain. The experiments were most liked by the pupils.

Verifying revealed that pupils found the activities interesting – most interesting were the ones in which they examined different kinds of plastic materials and their labeling as well as the experimental activities in which they studied properties of plastic materials.

Teachers involved in verifying appreciated the inquiry-based activities for approaching the topic. They appreciated the activities more than the traditional teaching – approaching the subject matter mainly by means of theoretical knowledge. They started separating waste at home and at school.

## Conclusion

Inquiry-based activities in project-based education offered pupils active as well as experience-based learning. They also created some space for self-learning and developing key competences. In implementing such projects as „It is Incineration Plant to Be Blamed“ and „To Recycle or to Throw away“ different forms of an inquiry-based method were used, such as experimental activity of pupils (determining properties of plastic ), theoretical activity of pupils ( kinds of plastic and their labeling, recycling plastic, decomposition of plastic, etc. ). The results of testing the effectiveness of the digital library with inquiry-based activities revealed that the activities had had a highly motivating character and had caused a change in pupils' attitude to science. Pupils' interest in chemistry itself as well as their environmental awareness had increased – they started to separate waste not only at school but also at home and in their neighborhood. They realized that plastic represents an enormous part of produced waste which, if not separated, would end up in incineration plants or landfill sites. We assume from the above that project teaching with inquiry-based activities largely contributes to making science teaching more effective. The disadvantage is mainly time-consuming preparation of education unit.

## Acknowledgement

The paper was written with the support of national KEGA grant n. 027UPJŠ-4/011 Creation and implementation of digital library for teaching of cross-cutting themes of the national educational programme as well as the international 7FP project ESTABLISH (European Union's Seventh Framework Programme FP7/2007-2013 under grant agreement n° 244749).

## References

1. GANAJOVÁ, M., KALAFUTOVÁ, J., MÜLLEROVÁ, V., SIVÁKOVÁ, M. : Project based learning in chemistry. Bratislava: ŠPÚ, 2010. p.144. ISBN 978-80-8118-058-3.
2. Establish project, available at [http:// www.establish-fp7.eu/](http://www.establish-fp7.eu/).

## Strategies to Teach Chemistry for Environmental Management Bachelor Students

Nágilla F.S. CARDOSO<sup>1</sup>, Ingrid F.D. da CRUZ<sup>1</sup>, Lauane M. SILVA<sup>1</sup>, Carolina C. MOLINA<sup>1</sup>,  
Rodrigo G. GARRIDO<sup>2</sup>, Fabiola de S.R.G. GARRIDO<sup>1</sup>

1. Universidade Federal Rural do Rio de Janeiro, DCAA, Avenida Prefeito Alberto Lavinias, 1847  
Centro – Três Rios/RJ – CEP 25802-180 - Brazil

2. Instituto de Pesquisas e Perícias em Genética Forense, Rua Marques de Pombal, 150  
Centro – Rio de Janeiro/RJ - Brazil  
E-mail: [fabiola\\_srg@yahoo.com.br](mailto:fabiola_srg@yahoo.com.br)

### Abstract

*Chemistry is a central discipline for Environmental Management Course students. In order to enhance their academic performance, it was used a context-based approach. Themes such as hazardous waste in water and soil; indoor air quality; recycling of cooking oil and waste were selected to be used at chemistry's disciplines teaching. This work aims to present different ways in which chemistry topics were presented for a non-chemical course during 2011 classes, as strategies to improve academic interest and performance. Every theme was discussed with students as teaching subject, so that they noticed whenever serious environmental impacts may be caused by ordinary use of products and technology. To study solutions fundamentals and pH they took part into the water global experiment, to celebrate International Year of Chemistry/2011. At this time, students discussed pollution effects over river physicochemical conditions. Oil esterification was used for two purposes. Firstly, to study acid basic reactions. Also, they presented a project for recycling of cooking oil in order to produce soap. This project was designed for small workshops at university. While studying batteries and lithium cells, they proposed collection to avoid disposal in common waste. The group produced panels which contained necessary information about daily attitudes citizen members should take to solve local problems, improving scientific argumentation. Environmental context-based approach and class workshops were effective strategies to maximize the benefits of academic interest and performance of students.*

**Keywords:** chemistry education; environmental management bachelor course; context-based approach

### Introduction

The outrageous concept of teaching chemistry for non chemical courses allows teachers to deal with chemistry curricula in a way that society processes and products are relevant to discuss several topics [1]. In this work, waste disposal, hazardous waste in water and soil; recycling of cooking oil and technology were used to offer chemistry topics for environmental management bachelor students. In order to enhance their academic performance, it was used a context-based approach that improves individuals and group skills, such as working with novel problems and planning their solutions; interpretation of scientific information and argumentation, as well as communication, information retrieval and time management [2-3]. This work intended to introduce students to Context-based chemistry education. It aims to improve student interest and motivation in chemistry by connecting chemistry concepts with real-world contexts [4].

For several times, teachers and chemistry education scientists refer to chemistry as a field to which students might not turn their attention forward [5-7]. Sometimes, classes may be less attractive, or students do not deposit efforts to listen; do not have proper cognitive ability or even previous knowledge [7]. However, teaching practices pointed out experimentation and contextualization as a way to succeed [8-10]. Although teacher-centered instruction still remains as a solution to improve education, the quality of learning depends on the effort being put on by the learner and experiences showed student-centered-learning[7] as the way to enhance scientific knowledge and widespread students' curiosity and interest.

Above all, scientists are engaged with society. It means that stimulating students to deal with problems that straddle the scientific and technical worlds should enhance their possibilities to develop skills, their language and domain of multiple chemical concepts<sup>5</sup>. Otherwise, people could not feel as they are part of the solutions for many questions that remain to be discovered. From Giacomo Ciamician, for example, emerged important concepts, such as students should be educated of what is worth doing with science [11].

Whether these principles were taken into consideration by authors, it was possible to plan strategies to teach chemistry for incoming students. The Environmental Management Bachelor Course at Federal Rural University in Rio de Janeiro [12] was created due to REUNI project [13], in a campus of Rio de Janeiro State interior region. Basic cycle entering students should course General Chemistry and Biochemistry at first year.

As well as the Lisbon Agenda, which seeks to promote the development of a Europe-wide knowledge-based economy [7], Brazilian REUNI project intended to spread out a great number of new *campi* [14], so that highly qualified citizens had had its number increased. Nevertheless, increases in resources have not been planned yet [15-16].

In terms of structure, students face up to laboratories which were not built until now, what means that teaching-learning process has a limit of didactical resources [15]. Also, first-year students bring together with them misunderstandings due to scientific education offered previously [17], and they show common absence of interest over classical chemistry topics [1], what can be found to be common for a non-chemical course.

### Material and Methods

During 2011 classes, it was made a different plan to teach General Chemistry for Environmental Management Course students. There were some environmental problems that had been discussed, in order to spawn the sense of chemistry as part of their lives and profession. Then, students took part into projects which themes were classic topics at general chemistry.

This work have made an educational approach by dividing themes into two proceedings: practical classes and projects. Some subjects, such as Atomic Structure and pH, were discussed after an experiment offered to students. The phenomenon was observed and they were asked to analyze results as well as its applicability.

As table 1 showed, subjects had been chosen among topics at the curriculum and the corresponding proceeding was used with the students.

**TABLE 1** – Subjects chosen among topics at the curriculum and the corresponding proceeding used with Environmental Management Bachelor students.

Subject	Proceeding
Atomic structure	Fluorescence present at natural compounds [18]
Solutions and pH	Water Global Experiment [19] pH scale, using natural pigments (anthocyanin) as indicators [15,17]
Acid-basic reactions	Cooking oil esterification [20]
Electrochemistry	Waste disposal project

Firstly, Atomic Structure was discussed after the reproduction of a practical class of luminescence [18]. In this practical class, protoporphirin IX, obtained from brown eggshells with acetone solution; a hydrophobic solution of chlorophylls and quinine soft drink were samples used to be illuminated with an UVA device inside a black camera.

In order to study solutions fundamentals and pH, they took part into the water global experiment, to celebrate International Year of Chemistry [19]. They have made an expedition into the Paraíba do Sul river margins and collected water samples and temperature data. Indicators were previously given to university. In spite of this, a pH scale done with natural indicator anthocyanin was used [15,17]. Black beans aqueous extracts, beet and violet cabbage alcoholic extracts were obtained by maceration. After that, they were used as indicators to build a pH scale.

The second way chosen to deal with complex subjects in a multidisciplinary way was a project. One was designed to study waste disposal at Três Rios/RJ city. It was divided into five topics: how frequently and what kind of waste was collected; what level of garbage previous separation there was in the city; what was done with residues from batteries; what were the health risks workers got through and, finally, what were the different waste disposal systems and well-succeeded sanitary landfills projects students could identify.

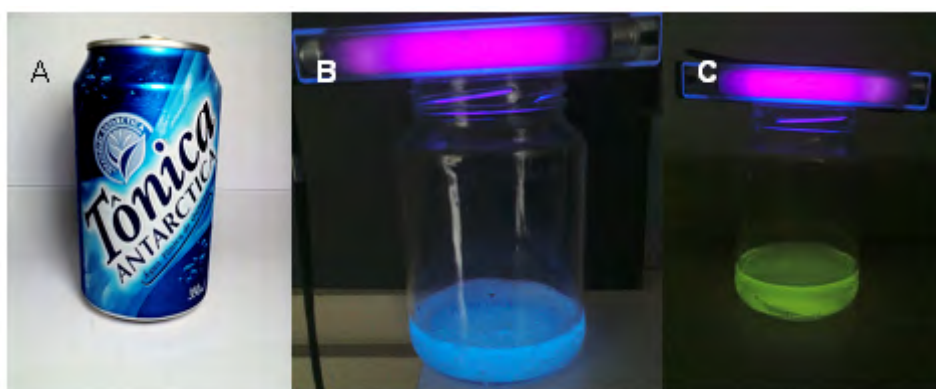
Also, they presented a project for recycling of cooking oil in order to produce soap. This project was designed for small workshops at university. Used oil was collected from residence. Then, after filtering and warming oil until 60 °C, it was mixed with a NaOH 10% solution. It was added to a beaker oil and then sodium hydroxide. After mixing with a wooden spoon, a solid paste was obtained. Plastic devices received the paste and it remained a day to solidify [20].

In order to assess performance, they were asked to produce panels which contained necessary information about daily attitudes citizen members should take to solve local problems.

## Results and Discussion

It was possible to choose solely some themes in the program, in order to make practical work. However, the idea was to give students additional pedagogical resources to build up chemical concepts [4].

After Atomic Structure experiment, students noticed that the substances emitted fluorescence. Once the phenomenon was observed, it was made the study of Bohr's atom and its linkage between biological events and physiology, such as photooxidation (Figure 1).



**Figure 1** – Tonic water (A), which contains quinine ion UV radiation (B) presents fluorescence. In C, there is an aqueous solution of B complex vitamins [18].

In pH classes, students discussed Paraíba do Sul River contamination in 2008, as part of an environmental accident [21]. With pH value, the global water experiment [19] databank was fed (Figure 2).





**Figure 2** – Rio Paraíba do Sul pH analysis. In A, samples received indicators; B, Students at the margin collected sample.

Also, instead of making a single analysis, it was made a pH scale with anthocyanins indicators extracted from natural resources such as blackbeans, beet and violet cabbage [15]. It was discussed the acid-basic behavior of substances, to study solutions fundamentals and pH (Figure 3). At this time, students discussed pollution effects over river physicochemical conditions.



**Figure 3** – Red cabbage (A); black beans (B) and beet ©  
Extracts were made to build a pH scale

While they were divided into groups to analyze waste disposal in the city, questionnaires were used to guide their investigation at the landfill. They listed materials that were collected by workers. Also, hazardous waste was found to be dumped on the soil, what they noticed to be dangerous, because of high concentration of heavy metals. Behavior and the use of technologies were discussed. While studying batteries and lithium cells, they proposed collection to avoid disposal in common waste.

Oil esterification [20] was used for two purposes. Firstly, to study acid basic reactions. Every theme was discussed with students as teaching subject, so that they noticed whenever serious environmental impacts may be caused by ordinary use of products and technology.

In order to assess performance, they were asked to produce panels which contained necessary information about daily attitudes citizen members should take to solve local problems. It has improved scientific argumentation. Environment context-based and class workshops were effective strategy to maximize the benefits of academic interest and contributions of students.

It seems interesting to amplify the number of subjects studied in a context-based way.  
 Perspective: Number of topics will be increased

## Conclusion

Environmental context-based methods and class workshops were effective strategies to maximize the benefits of academic interest and performance of students. Also, it was possible to give students additional pedagogical resources to build up chemical concepts.

## Acknowledgments

Authors are grateful for grants from Brazilian Ministry of Education Tutorial Program, which supported three students and for presentation provided by Federal Rural University from Rio de Janeiro.

## References

1. J. Holbrook, *Chemical Education International*, 2005, 6, 1.
2. S.T. Belt, M.J. Leisvik, A.J. Hyde, T.L. Overton, *Chem Educ Res Pract*, 2005, 6(3), 166.
3. L.P. Sá, S.L. Queiroz, *Quím. Nova*, 2007, 30(8), 2035.
4. D. King, *Studies in Science Education*, 2012, 48, 1.
5. H.W.P. Carvalho, A.P. Batista. *Experiências de Ensino de Ciências*, 2007, 2(3), 34.
6. M.L.T.G. Mendonça, R.P. Cruz, 31ª Reunião Anual da SBQ, 2008, 1.
7. I Eilks and B. Byers. *Chemistry Education Research and Practice*, 2010, 11, 233.
8. R.F. Leite, M.A. Rodrigues, *Ciência & Educação*, 2011, 17, 1, 145.
9. R.G. Garrido, F.O. Araújo, T.H. Oliveira, F.S.R.G. Garrido, *RBEBBM*, 2010, 1, 1.
10. M.A.C. Albuquerque, A.H.C. Amorim, J.R.C.F. Rocha, L.M.F.G. Silveira, D.F. de M. Neri, *Revista Brasileira de Educação Médica*, 2012, 36 (1), 137.
11. P. Ceroni, A. Credi, M. Venturi, V. Balzani, *Photochem Photobiol. Sci.*, 2010, 9, 1561.
12. UFRRJ, Projeto Político Pedagógico do Curso de Gestão Ambiental. [http://r1.ufrj.br/wp/itr/wp-content/uploads/file/ITR/g\\_amb/PROJETO\\_G\\_AMB\\_%20ITR\\_APROVADO\\_CEPE.pdf](http://r1.ufrj.br/wp/itr/wp-content/uploads/file/ITR/g_amb/PROJETO_G_AMB_%20ITR_APROVADO_CEPE.pdf). Accessed 27 april 2012.
13. Brasil. Decreto n. 6.096, de 24 de abril de 2007. Institui o Programa de Apoio a Planos de Reestruturação e Expansão das Universidades Federais - REUNI.
14. J.F. Cislighi, *Serv. Soc. Soc.*, 2011, 106, 241.
15. F.R. Freitas-Rego, M.G. Pereira, S.O. Loureiro, M.T.de Santana, R.G. Garrido, F.S.R.G. Garrido, *RBEBBM.*, 2007, 7, 21.
16. A.C. Pinto, *Revista Virtual de Química*, 2012, 4, 2, 101.
17. M.V. Dias, P.I. Guimarães; F. Merçon. *Química Nova na Escola*, 2003, 17, 27.
18. A.L.P. Nery, C. Fernandez, *Química Nova na Escola*, 2004, 19, 39.
19. IUPAC, The International Year of Chemistry 2011 (IYC 2011), Activities: pH of the planet, <http://www.chemistry2011.org>, Accessed 09 august 2012.
20. P.A.deA. Freitas, A.F.daS. Mariano, J.deA.Couto, J, X JORNADA DE ENSINO, PESQUISA E EXTENSÃO – JEPEX, 2010.
21. C.A. Spadotto, M.A.F. Gomes, M.B. Matallo, L.C. Luchini. XIII Congresso Brasileiro de Águas Subterrâneas, 2011.

## Models from history to the classroom: an historic-epistemological approach to chemistry teaching

Elena GHIBAUDI, Alberto REGIS, Ezio ROLETTO

*Gruppo SENDS, Dip. Chimica, Università di Torino, Via Giuria 7, 10125 Torino (Italy)*

*E-mail: elena.ghibaudi@unito.it tel. 0039-011-6707951 - fax. 0039-011-6707951*

### Abstract

*Far from being presented as a main epistemological obstacle, the discontinuous nature of matter is usually taken for granted in chemistry teaching and the atomic hypothesis is reduced to a mere conceptual instrument that provides an interpretation - at the microscopic level - of Proust's empirical law of the definite proportions. In this paper we will show an example of how the history of chemistry can be exploited as a source of problematic questions aimed at driving students towards the elaboration of a molecular/atomic model of matter. In particular, a teaching sequence focused on the discussion of the experimental results by Gay Lussac on the reaction between gaseous substances, may lead students to formulate the existence of atoms and molecules as a necessary hypothesis to explain the experimental findings, through a spontaneous evolution from Dalton's particle model to Avogadro's hypothesis.*

### Keywords

History of chemistry; situation-problème; interactive teaching; particle model of matter; Avogadro's hypothesis; atoms and molecules

### 1. The context of the present work

Chemical objects and phenomena may be described and interpreted at different levels:

level 1: macroscopic

level 2: atomic and molecular

level 3: electronic and nuclear

Chemistry explains the perceptible reality by recurring to invisible entities: this implies that pupils acquire a mental *habitus* that has to be built and cannot be considered already present as an *a priori*. This step is often neglected in chemistry teaching and levels 2 and 3 are approached too early, as level 1 – the only one accessible to senses – is somehow given for granted. One of the main obstacle in learning chemistry is represented by this logical gap, that compels students to accept the existence of microscopic objects (such as atoms, molecules, electrons, etc) almost by faith, whereas these objects should be proposed as conjectures (i.e. mental constructions) aimed at providing plausible and coherent explanations to experimental data. A strategy to overcome this problem consists in putting students in front of those very same problematic situations that scientists had to face in their own work. In practice, this means to drive students to internalize the modalities through which the scientific knowledge is built, by using the history of chemistry as a source of problematic questions. This choice allows to follow a teaching path (from level 1 to 3) that offers students a more realistic idea of science, intended as an hermeneutic instrument of the physical reality.

Matthews states: «*The purpose of historical and philosophical dimensions in science teaching is not just to provide still more things to know, it is to promote an awareness of interesting and important questions and a concern with their resolution*». According to this philosophy, our teaching approach consists in transposing an historical trace to the teaching level. This allows to organize the teaching of disciplinary contents in a way that integrates the historical evolution of the discipline with the (re)construction of the scientific knowledge made by students. In other words, historical materials are employed as teaching resources for planning learning paths with a double goal: i) to drive student towards the acquisition of di-

disciplinary knowledge; ii) to let them familiarize with questions, problems and the logical way of reasoning typical of scientists. In few words: applied epistemology. In such a way, the use of history does not aim at making students aware of how chemists demonstrated the existence of a microscopic world; it rather allows them to realize that the existence of such world and the organization of its components was a consistent idea with respect to the macroscopic findings recorded by chemists.

To design a teaching sequence based on the history and epistemology of chemistry means to exploit the very same questions and problems that scientists of XIX century had to cope with and to translate them into “learning opportunities” within a teaching environment that recognizes the student as the main actor of the learning process. Apart from the epistemological and historical aspects, this also recalls the learning psychology: in fact, this approach requires the passage from an “expositive” teaching to an “interactive” teaching, where problematic situations are exploited within the allosteric learning model [1].

In this paper, we will show a fragment of a teaching sequence that drives students to elaborate the concepts of chemical reaction, atom and molecule, by re-inventing Avogadro's hypothesis. This knowledge is not directly accessible from practical experience: students have to acquire it through a modellization activity that goes through the same steps undertaken by XIX century chemists. In this way, their interests is risen, their curiosity is satisfied, and they learn new concepts according to an in-depth modality that drives them towards the understanding of the epistemological status of a model. More in details, by involving students in the controversy between Gay-Lussac's empirical evidence on gas phase reactions and Dalton's atomic hypothesis, the teacher pushes them to activate their already established knowledge and to elaborate coherent and fruitful logical explanations, such as Avogadro's ones, in order to find a plausible justification for the experimental data.

## 2. Building up a teaching sequence

To understand an empirical situation means to represent it by a suitable model, that allows to interpret and even predict the behaviour of the empirical world. The deep understanding of the macroscopic aspects requires necessarily a correct representation of their microscopic counterparts. To built models of visible phenomena by imagining an invisible world was one of the main obstacles for XIX century scientists. Similarly, to built model for explaining empirical situations is a main source of difficulties in chemistry learning and teaching [2,3].

The historical evolution of chemistry, just like a step-by-step teaching, goes through the development of models whose limits are progressively highlighted. In XIX century, chemists could initially rely on Dalton's model of the indivisible atom. Such model was subsequently challenged by Gay-Lussac's findings on gaseous reactions: the experimental data were inconsistent with the idea that atoms could not be further splitted. Such epistemological obstacle was removed by Avogadro, who formulated two hypothesis: i) the proportion between a gas volume and the number of molecules within such system; ii) the idea that a molecule of a simple gas (molécule intégrée - our simple substance) may include two or more elementary molecules (molécules simples - our atoms).

We aim at facing students with a similar situation as those above-described, asking them to build models according to the following schedule:

### 2.1 Phase 1

Students are first driven to accept the consistency of a particle structure of matter. They subsequently build a first model, where particles are indivisible (the rules of this model are established on the basis of Dalton's model): this model allows to interpret the physical transformations of matter; such particles are spotted as invariants in the transformation. Although, this does not allow to explain chemical transformations; thus, it turns out to be an obstacle for pushing the chemical knowledge further on.

### 2.2 Phase 2

The teacher's goal is to lead students to overcome the obstacle. He shows the students an experimental situation (e.g., the formation of a precipitate after mixing two homogeneous liquid solutions) whose explanation requires the student to employ the model they have built (invisible particles). By doing so,

they find out the limits of such model. As a first result, students realize the difference between physical and chemical transformations: they build up a new concept. In physical transformations, substances keep their identity, whereas they lose it in chemical transformations. In order to interpret this new phenomenon, students need to hypothesize that particles may be further splitted: this brings to the evolution of the particle matter towards a new model that admits the existence of composite particles.

Admitting the existence of divisible particles, made by smaller particles, raises a language problem: the teacher suggests to overcome it by calling “atoms” the smaller particles and “molecules” the composite ones. Two new notions have thus been introduced: those of atom and molecule.

### 2.3 Phase 3

Students are now invited to interpret the gas phase reactions between hydrogen and chlorine, hydrogen and oxygen, hydrogen and nitrogen, by using their modified particle model. They have to imagine how the atoms of the reacting gas combine in order to give the new product molecules. As a starting hypothesis, all molecules are diatomic, so to make their task easier. In order to solve these problems, students have also to speculate on the relationships between volumes occupied by gases and number of particles involved (first Avogadro's hypothesis).

As an example, we will show some results from a PHASE3-activity that is expressly based on the historical context, as it employs the same gas reaction as Gay-Lussac, it allows to conceptualize atom and molecule and it leads students towards the spontaneous formulation of the first hypothesis by Avogadro: equal volumes of different gases, at the same temperature and pressure, contain the same number of molecules.

### 3. Activity: the reaction between hydrogen and chlorine

We investigate the reaction between hydrogen and chlorine. As it is a gas phase reaction, let's assume to work at constant pressure and temperature. The experimental settings are the following (Fig. 1): a cylinder is sealed on each side by a mobile piston. A removable diaphragm splits the cylinder into two hermetic containers. The two containers occupy the same volume and contain  $1 \text{ dm}^3$  of gas each: container A bears hydrogen; container B bears chlorine. The diaphragm is then removed and the two gases react. As a result,  $2 \text{ dm}^3$  of a new substance are obtained: hydrogen chloride.

Students are asked to represent the starting and the final state of the system by using the model particle.



**Figure 1** - Left: hydrogen (A) and chlorine (B) are separated by a diaphragm; Right: the same system after removing the diaphragm.

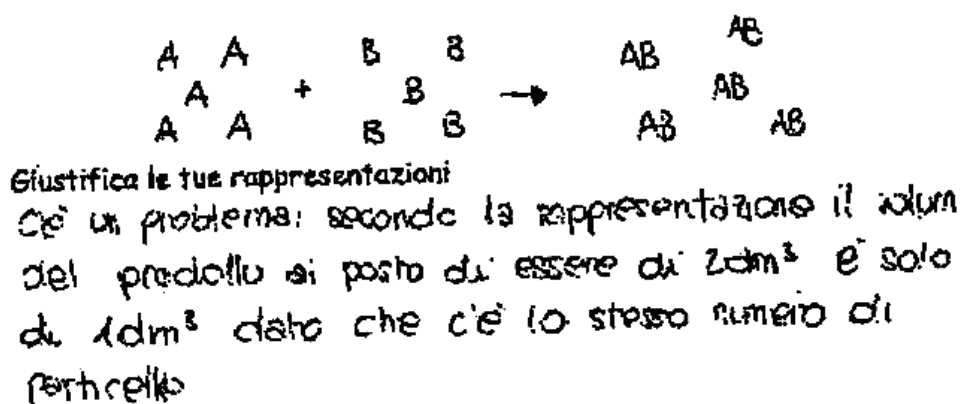
Students are in front of the very same problem faced by chemists in the XIX century. They have to explain both the chemical transformation of two starting substances and the volume change: a doubly problematic situation.

### 4. Results

In order to represent the particle structure of matter, students – who have not yet been introduced to the conventional language of chemical symbols - spontaneously employ iconic symbols (circles, stars, squares, rectangles, letters, etc.).

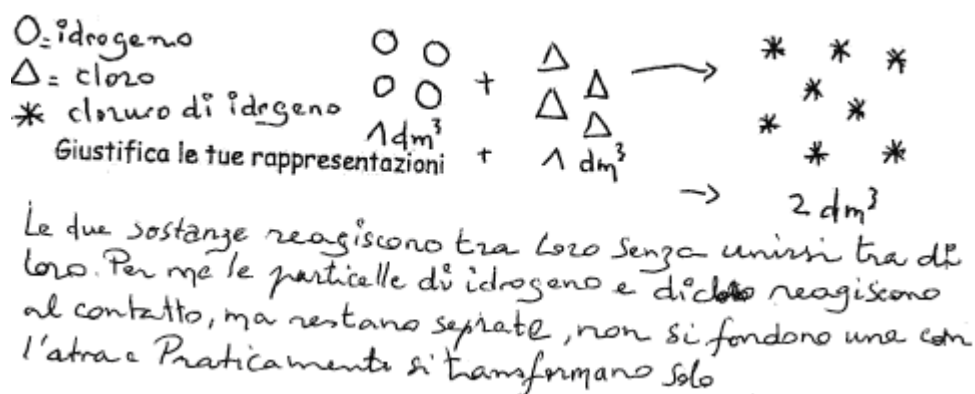
Most students represent the process by thinking of molecules made of a single indivisible particle. This makes evident the spontaneity of the mental process that drives them to hypothesize that equal volumes of different gases must contain a same number of particles, although someone advances different interpretations. Fig.2 shows that some students are aware of the fact that the experimental result is in con-

tradition with the idea of such proportionality. On one side, the leading idea is that a particle of hydrogen and a particle of chlorine give rise to a particle of hydrogen chloride; on the other side, the experimental data say that the final volume is double with respect to the single gases.



**Figure 2** - Student's comment: There is a problem: according to the representation, the final volume is 1 dm<sup>3</sup> (same number of particle as the single gases) instead of being 2 dm<sup>3</sup> (experimental data)

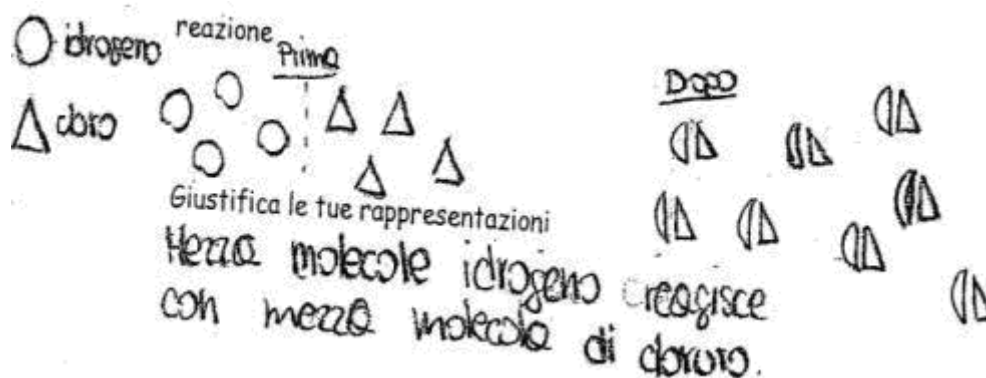
In order to overcome this contradiction, some students (Fig.3) represent a double number of hydrogen chloride particles, but – in order to justify this – they are forced to an acrobatic mental exercise: a student writes «The two substances reacts with each other without merging. To my opinion, hydrogen and chlorine particles react by contact, but keep separated, they do not fuse into each other. They just transform». The iconic representation of this student interprets the fact that the volume has doubled, but the verbal explanation highlights a misconception of the chemical reaction: he seems to think that a substance (molecule) may transform by remaining the same. The confusion is stressed by the introduction of a new sign for the reaction product, without a clear explanation of how this may happen.



**Figure 3** - Student's comment: The two substances react with each other without merging. To my opinion, hydrogen and chlorine particles react by contact, but keep separated, they do not fuse into each other. They just transform.

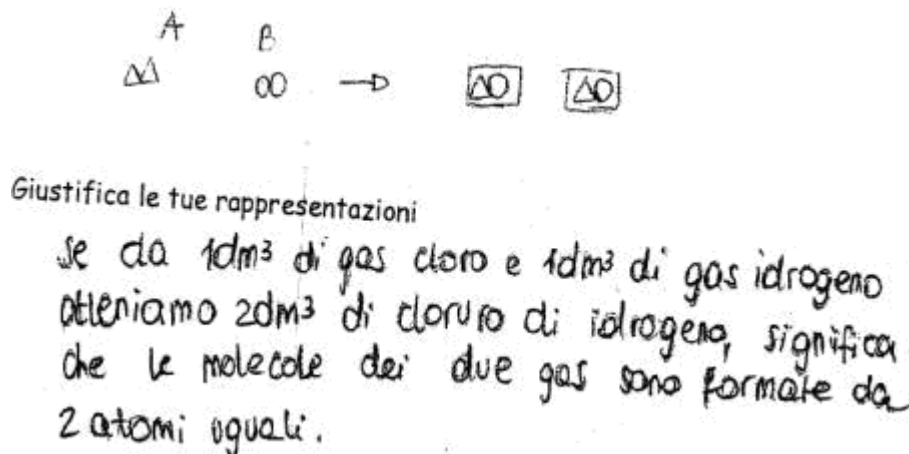
The argument brought by this student shows that he cannot yet handle the concept of chemical transformation correctly, although such concept seemed already acquired. This witnesses that the intellectual track for building up a concept is always tortuous and it is mostly appropriate to offer students learning situations that oblige them to challenge their apparently settled idea. The debate in the classroom brings some student to change their minds. Taking the proportionality between gas volume and number of particle as their milestone, they manipulate the iconic symbols so to get a representation consistent with the experimental data. Their hypothesis is that half of a hydrogen molecule combines with half of a chlori-

ne molecule (Fig.4), in analogy to the second hypothesis by Avogadro: «The hydrogen molecules react with those of chlorine by creating hydrogen chloride (substance). A molecule of hydrogen chloride is half formed by hydrogen atoms and half by chlorine atoms; as a consequence, when two gas molecules react with each other, two hydrogen molecules are generated. According to the previous experience, a double number of particles results in a double volume».



**Figure 4** - Student's comment: The hydrogen molecules react with those of chlorine by creating hydrogen chloride (substance). A molecule of hydrogen chloride is half formed by hydrogen atoms and half by chlorine atoms; as a consequence, when two gas molecules react with each other, two hydrogen molecules are generated. According to the previous experience, a double number of particles results in a double volume

Based on this reasoning, the discussion in the classroom has allowed the students to get over this intermediate step. As shown in Fig.5, the correspondence between gas volume and number of molecules is respected before and after the chemical reaction and thus it is coherent to hypothesize that the molecules of reactants are diatomic just like those of the reaction product.



**Figure 5** - Student's comment: If  $1\text{ dm}^3$  chlorine and  $1\text{ dm}^3$  hydrogen give rise to  $2\text{ dm}^3$  hydrogen chloride, this means that the molecules of the two gases are formed by two equal atoms.

#### 4. Conclusions

This work shows that it is possible to adopt a learning strategy that associates the scientific contents with their elaboration processes, according to the methods of scientific investigation.

Students are driven to cope with the evolution of interpretational models of the physical reality and this makes them progressively aware that the scientific knowledge is not a once-for-all established truth that may be reached by experience; it is rather the product of intellectual paths made of questions, problems, researches and answers that undergo a constant evolution and are progressively enriched with time.

In the modellisation activity, a central role is played by iconic symbols, that have to not be thought as a

raw instrument of an uncertain thought. It is rather a privileged heuristic instrument for exploring the structure of matter and its transformations. The iconic symbol has not to be intended as a simplifying teaching support: it is rather a formidable instrument that allows students (just as it happened to scientist) to access the microscopic level, by moving from the same scientific problems that ancient chemists had to cope with [4]. In contrast to a microscopic approach that offers very early the concept of atom to the student and it is based on the manipulation of chemical symbols incomprehensible to most pupils, this approach allows to introduce a great number of students to the logic of scientific research. By a direct (i.e not mediated) access to the microscopic level, students are given a false idea of how chemistry evolved and the distinction between experimental and model level is hidden. This way chemistry becomes «*an incomprehensible discipline, consisting of an enormous series of concepts to be learnt by memory*» [5].

## References

- [1] Giordan A., In Giordan A., Girault Y., Clément P., *Conceptions et connaissances*, Peter Lang, Berne (Switzerland), 1994
- [2] Tsapalis G., *J. Chem. Educ.*, 1997, 74, 922-925.
- [3] Nelson P.G., *Chem. Educ. Res. Pract. Eur.*, 2002, 3, 215-228.
- [4] Kozma R., Chin E., Russel J., Marx N., *Journal of the Learning Sciences*, 2000, 9, 105-143.
- [5] Fochi G., *Il segreto della chimica*, TEA, Milano (Italy), 1999



## Alternative Documentations of Experiments: A Differentiation and Diagnosis Tool in Chemistry Lessons?

Katharina GROSS, Christiane S. REINERS

*University of Cologne, Institute of Chemistry Education Herbert-Lewin-Str.2, D-50931 Cologne  
E-Mail: katharina.gross@uni-koeln.de*

### Abstract

*The following paper presents how pre-service teachers can be enabled to develop and foster their diagnosis competence as a key aspect of teacher competence. With regard to the process of participatory action research, a practical approach to diagnose students' individual strengths and weaknesses is described.*

**Keywords:** Heterogeneity, differentiation, diagnosis competence, participatory action research

### 1. Introduction

For many years an adequate handling of student's heterogeneity is demanded from (chemistry-) teachers. Even though schools often try to achieve homogeneity in their classes, reality is different as especially the results of PISA have shown. Students are individuals and differ concerning their development and their achievements. Education is able to face this problem with the didactic principle of differentiation. Therefore teachers have been expected to reflect different possibilities of individual learning in (chemistry-) school lessons [1]. Keeping in mind that the intention of differentiation is to support individuality but at the same time to sustain diversity, we refer to Sondergeld and Schultz, who defined differentiation "as working to address the abilities, interests and needs (both perceived and real) of individuals" [2]. Such a definition stresses the fact that differentiation is one of the main tasks a teacher has to cope with by organizing teaching. As a prerequisite to develop and implement appropriate differentiation principles teachers should have the ability of diagnosing students' learning conditions, abilities and difficulties [3]. Diagnosis competence can be defined as the ability of teachers to adequately assess students' performance, learning strategies and conditions as well as their general (learning) prerequisites. Accordingly diagnosis competence includes two dimensions: Knowledge about students' state of development and achievement as well as the ability to put this knowledge into practice. Consequently holistic diagnosis is an essential element of teacher competence [4,5]. To assess students' individual development, abilities and achievement diagnosis instruments should be integrated into instruction directly and at the same time involve students actively.

### 2. Rationale

The research project aims at fostering diagnosis competence of pre-service teachers to offer them the opportunity to deal with heterogeneity adequately. With regard to the process of participatory action research pre-service teachers should work on practical, authentic and realistic problems in chemistry lessons to develop a deeper understanding of diagnosis competence. Therefore the whole project is constructed in the following manner: In the beginning we started with practical approaches and took a look at students' difficulties in chemistry lessons. We found out that one of the main problems was the adequate documentation of experiments. We developed alternative forms of documentation to face this problem and used them as differentiation measures. Instead of writing an experimental protocol the students should record a video, tape minutes and draw a chemistry-photo-story. The forms were evaluated with regard to their appropriateness as differentiation measures in the second part of the study. The following paper focuses on the question whether these alternative types of documentation can not only be used as differentiation measures for students but also as diagnostic instruments for teachers. This raises the following research questions: 1. Can these alternative forms of documentation be used as an adequate

diagnostic instrument? 2. Are these instruments furthermore suitable to develop and support diagnosis competence?

### 3. Design and Methods

To answer both of the research questions, we designed a course for pre-service teachers at the end of their study. This course was aimed at fostering their diagnostic competence and was designed with regard to the process of participatory action research. Participatory action research is known as an iterative process which empowers all participants in the educational process [6,7]. Oriented towards this method pre-service teachers in a first step developed an understanding of the problem as they were introduced to the theoretical background of diagnosing and teaching and as they made plans for intervention how they could diagnose students (learning) difficulties in general. After that the intervention was carried out, that means pre-service teachers worked on students alternative forms of documentation. During and around the time of the intervention, relevant observations were collected in different forms. By combining the steps “act” and “observe”, it emphasizes the formative nature of this methodology [7]. In a third step both researcher and pre-service teachers reflected, presented and discussed their results in the course. In particular the collective reflection and exchange of self-made experiences as well as the discussion among all participants helped to successively approximate and improve an adequate understanding of diagnosis competence. Then the data were examined for trends and characteristics and a new plan to approach the problem was developed and carried out. Pre-service teachers passed through this iterative cycle until they found out an adequate way to recognize, diagnose and assess students’ strengths and weaknesses related to their individual documentation. The goal of this method is to achieve desirable outcomes by process of repeated iterations [7]. Furthermore it is a form of self-reflective inquiry undertaken by all participants [8]. The course was qualitatively analyzed and evaluated in terms of process-portfolios which the pre-service teachers wrote during the course. In this context portfolios are ideally suited to construct, reflect and change participants’ personal knowledge of diagnosis competence for a specified period, because they support the procedure of participatory action research. Although the participants were generally free to use their own style, they received some guidelines in the form of central questions. After the intervention the portfolios were analyzed and evaluated in accordance with the qualitative content analysis presented by Mayring [9]. In order to answer the research questions a category system was created using the existing material as well as the corresponding theory.

### 4. Results

In the following the results of using videos as one alternative form of documentation are described and discussed. We were interested to know whether this alternative type of documentation can be used as an adequate diagnostic instrument. Table 1 presents the results concerning the first research question.

**Table 1** systematic results concerning the first research question

Categories	Examples
Strengths and weakness relating to adequate documentation of experiments - Adequateness with regard to content and formality - Terminology	"We just want to burn iron wool to determine whether it becomes lighter or heavier than before." "[...]the balance has to be tared." "The hot blue flame."
Students ability to experiment	"I think for the teacher it is a great chance to have the possibility to observe mistakes which students make relating to the experiment. Because of the alternative forms of documentation teachers are enabled to recognize strengths and weaknesses of their students in a better way."(2/27)
Social competence of students - cooperation and social interaction - communication and teamwork	"Social competences can be observed very clearly here. Both of the students are working in a team and complementing each other." (10/24)
Attitude e.g. fear, seriousness, motivation	"You can clearly see that the students did not really like to be recorded and to be filmed. The reason for that could be their age. Also the constant giggles indicate that they do not feel very comfortable."(11/22)

As shown in table 1 there are four categories which can be emphasized. The use of a video as an alternative type of documentation allows teachers to diagnose strengths and weaknesses related to adequate documentation of experiments, students' ability to experiment, their social competences as well as their attitudes towards the experiment and the way of documentation. The right column illustrates examples of participants' statements, which support the relevant category. Apart from the first category which can be assessed in a traditional experiment protocol as well, the other three categories are new. Obviously it seems as if the use of videos has an added value for teachers because it has the potential not only to assess common strengths and weaknesses. Moreover it is suitable to gain insight students social competences like, for example, their ability to work in a team and to communicate (chemical content) to each other and attitudes. In summary, we can assert that with the help of videos teachers are enabled to holistically diagnose students' performance, learning strategies and conditions as well as their general prerequisites and attitudes.

Concerning the second research question, i.e. whether these types of documentation are furthermore suitable to develop and support diagnosis competence, we found out that practical work with students' alternative forms of documentation pre-service teachers were able to develop and foster their personal diagnosis competence. Furthermore they gradually recognize the significance of diagnosis competence as well as the specific benefits for teachers. (i.e.: *"During the course I have developed some new ways to face problems. I especially was not aware of diagnosis competence and diagnosis instruments as key aspects of teacher competence. Now I realize their significance."* (19/18) and *"By analyzing the video I particularly became aware of how much one can learn from students' behavior and language about their general attitudes, problems and affections [...] I think teachers can achieve real benefits out of it. [...]"* (5/26)). As an additional outcome we could state that by the structure of the course, that means by the practically, authentic work on realistic problems and more over by the active participation, pre-service teachers became not only aware of students' learning difficulties but also increased their diagnosis competence. (i.e. *"Through my own practical work I have got an idea about the problems students have. I did not realize this before."* (2/24) and *"[...] The course encourages me to develop new thinking processes which confirmed my decision to become a chemistry teacher. More over I have the feeling that these thinking processes are independently developed and I am proud of it."* (12/43)).

## 5. Conclusion and Outlook

Diagnosis competence can be adequately developed and trained in the context of a course at the university and with regard to practical examples at an early stage of pre-service teacher education. Diagnosis competence is essential to face heterogeneity adequately. Our future interest focuses on the possibility to design a module for the new bachelor and master programs at our university by using the resulting experiences. In the long run we are aiming at a sustainable improvement and professionalization of teacher education.

## Acknowledgments

I acknowledge with gratitude FCI (Fonds der chemischen Industrie) for their financial support of the project.

## Notes

- [1] C.-J. Guo, Issues in science learning: an international perspective. In: S.K. Abell, N.G. Lederman (Eds.), Handbook of research on science education, pp.227-256, Erlbaum, Mahwah, NJ, (2007).
- [2] T.A. Sondergeld, R.A. Schultz, Gifted Child Today, 2008, 31, 34-40.
- [3] C.A. Tomlinson, Educational Leadership, 2000, 58, 6-11.
- [4] R.D. Hoge, T. Coladarci, Review of Educational Research, 1989, 59, 297-313.
- [5] N. McElvany, S. Schroeder, A. Hachfeld, J. Baumert, T. Richter, W. Schnotz, H. Horz, M. Ullrich, Zeitschrift für Pädagogische Psychologie, 2009, 23, 223-235.
- [6] R. McTaggart: Adult Education Quarterly, 1991, 41, 168-187.
- [7] G. Bodner, D. MacIsaac, S. White, University Chemistry Education, 1999, 3, 31-36.

- [8] D. MacIsaac: An Introduction to Action Research. <http://physicsed.buffalostate.edu/danowner/actionrsch.html>. (accessed 6 July 2012)
- [9] P. Mayring: Qualitative content analysis – research instrument or mode of interpretation?. In: M. Kiegelmann (Ed.), *The Role of the Researcher in Qualitative Psychology*, pp.139-148. Huber Tübingen, (2002).

## Multibook, an Electronic Book

Hanna GULIŃSKA

*A. Mickiewicz University in Poznan, Faculty of Chemistry, Grunwaldzka 6, 60-780 Poznań, Poland,  
gulinska@amu.edu.pl*

### Abstract

*The school year 2012/2013 marks the beginning of a new school reality in Poland. According to the new curricular basis introduced in our country in 2009, teaching must be focused around the media and the experiment. In the same year, a new junior high school leaving examination was introduced. The above decisions have determined further educational improvements which are of great help both for teachers and their students as well. These include electronic books, or the so called multibooks. One of the biggest educational publishers prepared all of the necessary handbooks for junior high school students (aged 13-15) in a form of a multibook available on CDs or flash drives.*

**Key words:** multimedia, chemistry, information technology, visualisation, educational platform.

### Introduction

#### Some of the functionalities of the *Exciting Chemistry*<sup>1</sup> multibook

1. Most of illustrated drawings and diagrams may serve as tasks checking the levels of concentration and assisting students in memorizing the content of the lesson.
2. The tasks that are usually available in the regular handbook, in the multibook are presented to the student in a random order. Obviously, the solution is available along with the task. Thus, students immediately receive the answer whether their own solution is correct or incorrect.
3. A lot of information that was not enriched with illustrations in the printed version, in the electronic book has some illustrations added. It is up to the teacher to decide which and how many additional elements should be added in a given class.
4. The animations, videos and interactive tasks presented on most pages encourage even the less interested students to work.
5. While in the traditional handbook, illustrations constituted just interesting elements, in the multibook students point to a given word with the cursor, their finger, or a pen to change the static drawing into a lively image.

Another advantage of the multibook is a set of tools for interactive cooperation between teachers and students. This is a dream come true for both parties to the educational process. You can print the elements of the books, you can write and draw directly on its pages, you can make notes on special flash cards which will never be misplaced. At the end of the day, the handbook still remains untouched and ready to serve another class.

#### MultiBook – an electronic book

MultiBooks are designed to be used in class where each student has their own traditional manual and the teacher presents its electronic version on the screen or on the interactive whiteboard. However, it is not necessary for the students to use traditional handbooks. It is very convenient when the teacher uses the multiBook to illustrate their words with videos and animations. An interactive whiteboard makes teaching easier but at the same time, it encourages students to a much more active participation in the class. They can follow their classmate who solves a problem on the whiteboard using only an electronic pen or just a finger.

1. H.Gulińska, J.Smolińska, *Ciekawa chemia – multibook*, WSiP 2011

Working with a multiBook makes it much easier to use the multimedia which were previously available at various locations within the package, either on the student's CD, the class CD attached to the teacher book or in books with additional exercises. It is not necessary now to look for the elements to be presented or change the CDs during the class; as a magic wand, one click will open the necessary elements.

Below, several examples of didactic situations in Chemistry lessons are presented.

1. When the teacher demonstrates an experiment, their hands and thoughts are involved in the demonstration. There is no time to look for the necessary video sequences; in the multiBook, however, there is an icon of the relevant video. By clicking on the icon, behind the teacher's back, on the interactive whiteboard the video is presented. Each scene can be described directly on the video screen, a photo can be taken by means of the tools offered by the board. The photo may be inserted in the presentation; it may be printed and handed out to students to be glued in their notebooks. The pages of the book can be changed by the students as well as the teacher.
2. During the lesson, the teacher asks the students to do the tasks defined in the manual. When the teacher decides that the students have had enough time to solve the tasks, they click on the solution icon and the class can check if they have done their tasks correctly. While giving the students their home assignment, the teacher clicks the relevant icon and the enlarged instruction appears on the screen. By using the tools offered by the multiBook, the teacher can explain the details of the homework.

3. The teacher discusses an illustration presented in the textbook, dictates a definition to be written down in the notebooks, explains a difficult word or needs some data from a table at the back of the book. In any of the above situations, one click on the relevant icon opens the needed window that can be enlarged so that everybody can see the details, the table, or the definition.

### **Below several examples of the functionalities of the multiBook entitled *Ciekawa chemia*<sup>2</sup> (*Interesting Chemistry*)**

#### **WHEN A PHOTO BECOMES A TASK**

By clicking on the icon next to the photo, the numbers disappear and students can insert the relevant elements (here – the types of laboratory utensils).

#### **WHEN A DIAGRAM BECOMES A TASK**

Most of the illustrations and diagrams might be turned into tasks which is an excellent tool for checking the students' concentration and makes it easier for them to remember the material.

#### **WHEN THE TASK IS SOLVED**

Solutions to all the tasks given at the end of the lesson are available in the multiBook now, although they were previously provided either in the teacher book or on the CD attached to it. Presently, students can immediately get information if their solutions are correct.

#### **WHEN WE GET NEW PHOTOS AND INFORMATION**

A lot of information which was not illustrated before, is now enriched with additional illustrations. This makes understating the more difficult part of the material much easier. It is up to the teacher how much and exactly which additional elements need to be presented to a given class.

#### **WHEN THE CONTENT IS ILLUSTRATED BY ANIMATIONS**

Animations and interactive exercises, both the ones published on the student CD as well the previously unpublished ones, make the lesson much more attractive and encourage even the less interested students to work, especially that the results of their work can be checked immediately. The exercise solved on the interactive board gets a whole new dimension and cannot be compared to any similar exercise done in the student's notebook.

#### **WHEN WORDS TURN INTO PHOTOS**

Words bolded out in traditional handbooks, get a new meaning when they are transformed into a picture. The word 'brass' is just a word, whereas an image of a brass plate can be easily remembered.

#### **WHEN YOU CAN GET MORE PHOTOS**

Illustration used to be an interesting element of the traditional book but now the teacher just needs to ask students to point to a word and the previously static illustration get a whole new form.

#### **WHEN WE GET AN ADDITIONAL TASK**

The multiBook offers an opportunity to do various tasks which could not have been presented when the handbook had a traditional, paper form. The choice of tasks increases and it is up to the teacher when and how they should be done. Needless to say, the authors provide their suggestion in the relevant lesson scenarios.

The multiBook is also equipped with a set of interactive tools that can be used by students and the teacher. The dream is just coming through as the elements of the book can be printed, students can write directly in the book, they can make notes on special flashcards which will never get lost. And after all these operations, the multiBook remains exactly unharmed and may be used by new groups of students. Some of the above options are presented below.

### **Electronic workbooks *Ciekawa chemia*<sup>3</sup> (*Interesting Chemistry*)**

A new junior high school exam will check the students' knowledge and skills in 2012. To answer the challenge, a new internet portal WSiPnet.pl has been prepared. It includes online workbooks as well as a number of additional benefits for teachers and students.

2. Gulińska H., Smolińska J., *Ciekawa Chemia*, WSiP, Warszawa 2011

3. Gulińska H., Smolińska J., *Ciekawa Chemia*, WSiP, Warszawa 2011

WSiPnet saves time and energy used for correcting the tasks and communicating the results to students. The correct result is immediately presented once the task has been completed. The result is simultaneously available to the teacher and the student. Thus the time consuming activity of correcting homework is shortened to just a few seconds. The immediate feedback motivates students and the list of results makes it possible for the teacher to monitor the students' progress.

It takes no more than just a few seconds for the teacher to send the students their homework related to a given lesson. Students are expected to complete their task within the defined time limits. The teacher gets a report of all the tasks with the result and some notes on the general and specific requirements of the curriculum which this particular task was to execute. The reports and lists are prepared automatically and thus they can monitor each student's progress. The teacher can view the work of each student at any time. There is a direct access to the reports so all the mistakes can be seen. WSiPnet offers the opportunity to monitor and diagnose each student as well as the whole class. By doing given tasks, concrete abilities and skills are practiced; the students fulfill the curricular requirements and they can see the evaluation provided by the teacher. The student analyzes their own table of results and can see their own progress. It is clear which parts of the material still need to be worked upon. Each lesson has its own set of tasks and the student knows exactly which elements should be practiced. The reports point to these parts of the material which require more attention while revising before the test. The WSiPnet system allows the teacher to check all their students' home assignments and results. The attractive form of feedback information motivates students to work even harder. WSiPnet offers the chance for better progress as the students' work can be monitored easier. The workload is placed in the framework of the new curricular requirements and thus saves the teacher a lot of time and effort. The automatic homework correction makes the teacher's work more efficient but it also constitutes a better motivation for the students.

### Summary

Teachers are going to be able to teach their classes in a traditional manner as well as by means of e-methods, i.e. they will teach their subjects in traditional classrooms as well as in computer rooms using the e-learning units. The teachers shall do the experiments suggested by Avatar, use the interactive board, monitor the students' progress by means of the e-learning platform in order to check their independent work with the e-learning units. The teacher is going to use the platform to talk to students, to discuss and solve various tasks. This type of work shall make it possible for the teachers to exchange experience and develop their skills of using information technology in teaching.

The success, or the lack of it, can only be discussed in three years' time. Nevertheless, the task is enormous as numerous schools and students are involved in it. However, once completed, it will assist schools in creative and attractive implementation of the new curriculum. What is most important, however, it will equip students with skills and competence necessary in their future life and work.

### Literatur

1. H. Gulińska, M. Bartoszewicz, *Natural science in the joint programme chemistry and nature*, Journal of Science Education vol. 9, 2008, s. 21-25
2. H. Gulińska *Interesting Chemistry – A Multimedia Task Collection*, Research, Reflections and Innovations in Integrating ICT in Education, FORMATEX, Badajoz Spain 2009, Vol. 1.978-84-692-1789-4, ss. 397-403
3. H. Gulińska., *Multimedial Handbooks of Chemistry – multimedia collection task*, ICT in Chemical Education, Wyd. Sowa, Poznań 2009, ISBN 83-89723-65-4, s. 31-38
4. H. Gulińska *Using new technologies in teaching chemistry*, Chemistry Education in the ICT Age, Springer 2009, 131-144
5. H. Gulińska *Modern computer games as elements of teaching chemistry in Polish junior high schools*, Journal of Science Education vol. 11, 2010, s. 4-7



## “A statistically manifested teaching concept about air, greenhouse effect, ozone and acid rain for major college students”

**Nina HARSCH, Hans-Dieter BARKE**

*Institute for Chemistry Didactics, Fliednerstraße 21, 48149 Münster, Germany*

*E-mail: nina.harsch@uni-muenster.de*

*Phone: 0049-251-8339467*

*Fax: 0049-251-8338313*

### **Abstract**

*Nowadays, atmospheric pollution is a current topic which also concerns adolescents and their future. Therefore, they should know how to explain global phenomena such as the anthropogenic greenhouse effect, the ozone hole and ozone smog, as well as acid rain (which is still an actual problem e.g. in China). As the understanding of these topics requires a significant amount of chemical knowledge, chemistry class is the perfect environment for their acquisition. Nevertheless, as these topics are interdisciplinary, they could also be incorporated into other natural science classes.*

*Asking adolescents about their understanding of chemical topics, misconceptions are a common problem. In this context, a survey with approximately 1.500 tenth and twelfth grade students from Germany, Spain, Taiwan and Russia was conducted. Particular emphasis was put on the technical knowledge, possible misconceptions and the attitude of the participants towards environmental protection. “All air pollutants are greenhouse gases.” - “The greenhouse effect is caused by the ozone hole.” - “Acid rain provokes chemical burn and cancer.”... Those and other misconceptions, amongst a significant general lack of knowledge, were discovered by this survey.*

*Based on these findings, a lecture series was developed and tested in chemistry class on German secondary school level students throughout a period of nine lessons. The learning progress was documented via pre-, intermediate- and post-tests. Comparing the positive results of the lecture series with the lack of knowledge of other (even older) students, the necessity of the official incorporation of these globally relevant topics in class becomes evident.*

**Keywords:** Greenhouse effect, ozone, acid rain, senior college students, empirical study, lecture series

### **1. Introduction**

Ever since the industrial revolution and its economical and social benefits, humanity has also been forced to cope with the environmental consequences of such vast growth and sustained development. Globally relevant atmospheric phenomena, such as acid rain, acid winter smog, ozoniferous summer smog, the destruction of the ozone layer, the anthropogenic greenhouse effect and climate change, have taken their permanent place in natural science research, as well as in the media and in everyday life discussions. Nevertheless, in Germany as well as in many other countries, there still is a lack of proper implementation of these topics into college education. Reasons for this might be their interdisciplinary character (most often, they involve chemical, physical, biological and geographical aspects) on the one hand, and the current “teach more in less time” politics, leaving little room for any off-beat content, on the other hand. Within the ongoing global climate change discussion, it is overlooked that young people are the ones who will have to deal with the consequences and thus imperatively need a solid knowledge base regarding atmospheric phenomena. In order to illustrate mankind’s power to really make a change, this should incorporate both current topics such as the greenhouse effect, and technically solved problems such as acid rain and the ozone hole.

Due to these reasons, an international empirical survey among 1.500 college students of grade 10 and 12 was conducted in order to evaluate the knowledge level and the possible misconceptions of the students concerning air, acid rain, ozone and the greenhouse effect<sup>1</sup>. Based on the findings of these survey, as well

as on literature research and expert consultations, a nine-hour lecture series was developed and applied in several classes. The structure and main results of both the survey and the lecture series will be succinctly presented in this paper.

## 2. Empirical Study

As mentioned above, the first part of this research project comprises an empirical survey about air and atmospheric pollution.

### 2.1 Questionnaire and Target Group

The questionnaire applied in order to investigate the students' knowledge and misconceptions about air and atmospheric pollution contains four subject areas:

- (a) Air: Atmospheric composition, differentiation of trace gases and air pollutants
- (b) GE: Definition of greenhouse gases, causes and consequences of the GE
- (c) OZ: Formation and destruction of stratospheric and tropospheric OZ, countermeasures
- (d) AR: Naturally and humanly caused AR, gas sources, countermeasures

Regarding the target group, due to the chemical complexity of the subject areas, the questionnaire was given to major students only, that is, grade 10 and, to have a cross-sectional comparison, also grade 12, of all common school types. In order to furthermore obtain an international comparison, the survey was conducted in several countries, specifically Germany, Spain, Russia and Taiwan.

### 2.2 Principal Findings of the Empirical Study

Almost regardless of age and country, the evaluation of the survey revealed a significant lack of knowledge, as well as several misconceptions throughout all four subject areas. The most important findings will be presented in the following. In order to give a total overview, the percentages always refer to the entire student population (that is, grade 10 and 12 together). More detailed results, incorporating age and country differences, can be found in [1].

Asking the students about the main air components, 78 % nitrogen and 21 % oxygen, only a mere 20 % of the students were able to give the correct reply, while most of the others over-estimated the carbon dioxide rate and/or sub-estimated the nitrogen rate. Looking at the minor air components and letting the students describe their notions of trace gases, air pollutants and greenhouse gases, it becomes clear that most of them don't differentiate between these three terms. Hence, to many of the students „all trace gases are air pollutants“ and „all air pollutants are greenhouse gases“.

Concerning the greenhouse effect, a 30 % of the surveyed pupils were able to give a correct description of how the GE works. When asked about the most significant greenhouse gases, only a mere 28 % of the pupils mentioned water vapour. Thus, it can be deduced that most of the students regard the GE to be completely anthropogenic (caused by humanity). Another very important misconception which can be found in the majority of the students consists in stating an interdependency between the GE and the ozone hole. To many of the students „the greenhouse effect causes the ozone hole“ or „the ozone hole causes the greenhouse effect“.

The topic „ozone“ (which incorporates both stratospheric and tropospheric ozone) showed low values for the recognition of tropospheric (ground level) OZ, which was known by only 21 % of the students. Stratospheric OZ, however, received better results, with a 44 % of the pupils naming the correct geographic location of the ozone hole (Antarctica) and again 44 % mentioning CFCs as a major factor for the depletion of stratospheric OZ. On the whole, it may be stated that for many students „ozone exists only in the ozone layer“. Furthermore, for those who did not know about the ozone hole above Antarctica, „the ozone hole is located above the industrial countries“, that is, above the countries with the highest emission rates.

1. As from now, the following abbreviations apply:

**GE: Greenhouse Effect**

**OZ: Ozone (stratospheric and tropospheric)**

**AR: Acid Rain**

The last part of the survey treated with acid rain. Here, the findings were that a 55 % of the pupils knew sulphur dioxide and nitrogen dioxide to cause AR, a 44 % furthermore correctly mentioned carbon dioxide and a 35 % were able to name some consequences of AR (e.g. deterioration of monuments, damage to forests, acidification of lakes). Regarding misconceptions, it can be deduced that those pupils who did not mention carbon dioxide, might be of the opinion that “acid rain is completely anthropogenic”. Apart from that, some of the students believe that “acid rain is concentrated acid”.

### 3. Lecture Series

The second part of this research project comprises the conception and application of a lecture series about air and atmospheric pollution. Regarding the conception, the results of the above described empirical study, as well as extensive literature research and expert interviews were accounted for.

#### 3.1 Conceptual Design

The conception of the lecture series comprised three working stages.

*The first stage* consisted in analyzing the knowledge level and the possible misconceptions of the target group concerning air, GE, OZ and AR. This was done via the empirical study described in chapter 2 of this paper. These results were furthermore compared to already published findings in literature. As a second step, extensive literature research was done concerning already existent teaching concepts about these topics. Out of this, possible didactical approaches were developed and then discussed with experts (such as teachers and scientists).

*Stage 2* represents the result of the discussed didactical approaches and can be seen as a pilot concept of the lecture series. This pilot concept is composed of 7 school lessons which are surrounded by a pre- and a post-test and can be divided into three parts: First, the students take three lessons to acquire basic knowledge about the 4 subtopics air, GE, OZ and AR by means of expert learning.<sup>2</sup> Then, the teacher uses one lesson to introduce a concept map in order to both recapitulate the basics and point out thematic interrelations. And finally, there are three lessons of teacher-class dialogue and experiments incorporating further knowledge about GE, OZ and AR.

*Stage 3* is the final, optimized teaching concept which is based upon the findings and eradicated weaknesses of the pilot concept. The three main weaknesses of the latter were:

- (a) The expert learning was too hard for weak students.
- (b) The topic “air” did not include any experiments and (thus) showed poor learning results.
- (c) The permanent topic rotation appeared to be confusing to the students.

Due to these findings, the pilot teaching concept had to be revised. The optimized concept therefore is structured as follows:

- Lesson 1: Teacher-class dialogue and experiments about the main air components. Definition and differentiation of trace gases and air pollutants.
- Lessons 2-4: Group learning.<sup>3</sup> Three groups with one topic each (GE, OZ, AR).
- Lessons 5-7: Each group presents their topic, including an experiment about it.
- Lessons 8-9: The teacher introduces a concept map in order to both recapitulate the basic knowledge and point out thematic interrelations.

2. **Expert learning:** Pupils are distributed into different thematic groups and then pass through the following stages: (a) individual studying, (b) exchange between experts, (c) each expert transmits their knowledge to their peer group. In this way, each pupil learns about each topic.

3. **Group learning:** Pupils are distributed into different thematic groups and then pass through the following stages: (a) group studying, (b) preparation of presentations, (c) each group presents their topic to the remaining students. In this way, each pupil learns about each topic.

### 3.2 Main Results of the Lecture Series

The main learning results of the pilot concept are shown in Figure 1 and Figure 2.

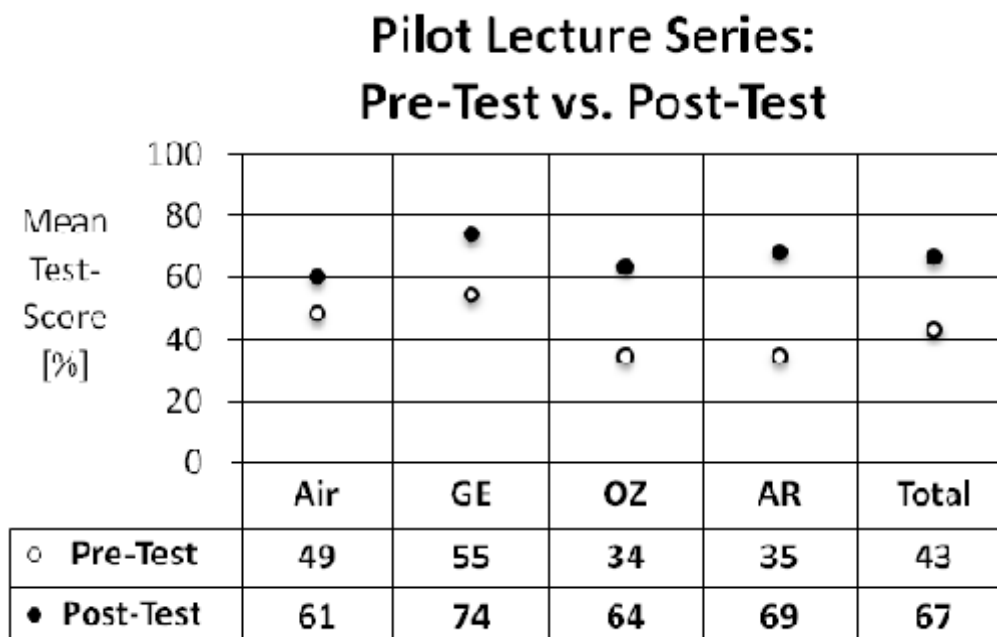


Figure 1 Pilot lecture series - pre-test vs. post-test

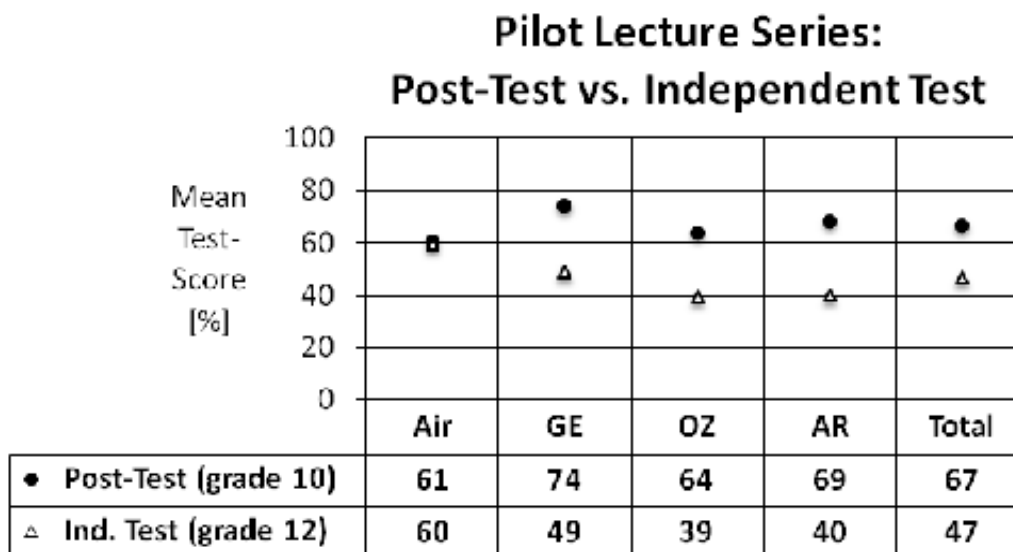
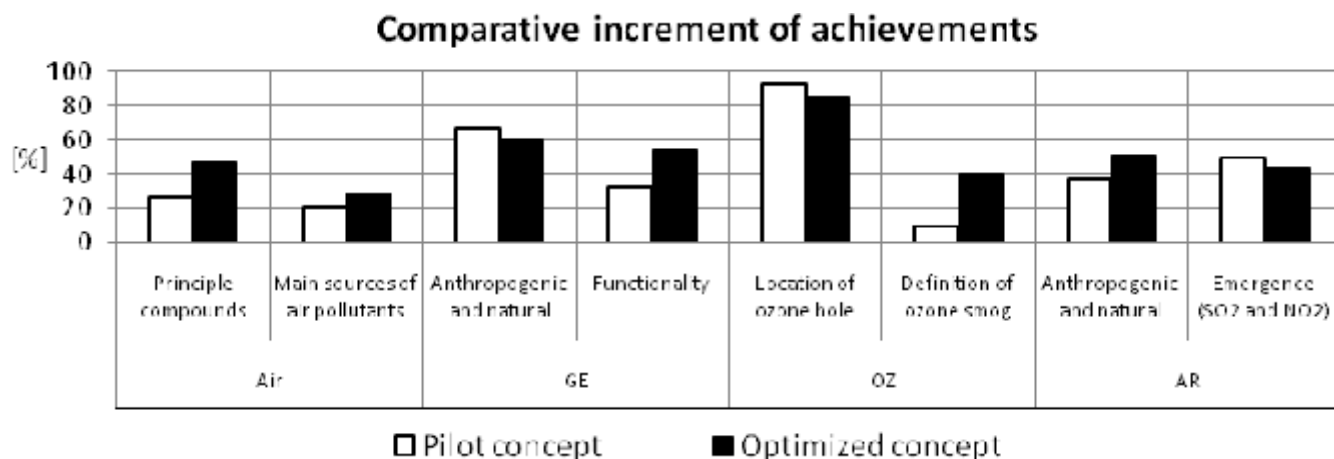


Figure 2 Pilot lecture series - post-test vs. independent test

Figure 1 shows the knowledge level of the pre-test in comparison with the post-test results. The improvement rates were 12 % for air, 20 % for GE, 29 % for OZ and 34 % for AR. On the whole, the pre-knowledge level was 43 % and the post-knowledge level was 67 %, which makes a general performance improvement of 24 %.

Figure 2 shows the knowledge level of an independent test (= pupils not taking part in the lecture series) of grade 12 in comparison with the post-test results (grade 10). Despite their younger age, the grade 10 students performed better than the ones of grade 12. The rate differences were 1 % for air, 25 % for GE, 25 % for OZ and 29 % for AR. On the whole, the knowledge level of the grade 12 students was 47 % and

the (post-)knowledge level of the grade 10 students was 67 %, which makes a 20 % higher general performance of the latter.



**Figure 3** Pilot concept vs. optimized concept: comparative increment of achievements

Figure 3 shows the differences in improvement comparing the relative pre-post-difference of the most important items of the pilot concept with the optimized concept. For air and OZ, the optimized concept shows better results than the pilot concept. Regarding GE and AR, the pilot concept shows slightly better results for some items. Nevertheless, on the whole, the optimized concept achievements are significantly higher than those of the pilot concept.

#### 4. Conclusions

The topic „air and atmospheric pollution“ is demanding and due to the complexity of the subject area, there is still room for further improvement of the lecture series. A survey amongst teachers showed their interest in the incorporation of the lecture series in their class, which is an important premise for its implementation. In order to assure the quality of the tuition, teachers' trainings are very important.

#### 5. Reference list

- [1] N. Harsch, C. Estay, H.-D. Barke, Praxis der Naturwissenschaften - Themenheft Schüler( fehl)vorstellungen als Chance, 2011, 3/60, 20-25.

## Decision-making on socioscientific issues – analyses of influential aspects

Julia HOSTENBACH, Maik WALPUSKI

University of Duisburg-Essen, Schuetzenbahn 70, 45127 Essen,  
 julia.hostenbach@uni-due.de  
 telephone number: +49201/1833761, fax number: +49201/1833149

### Abstract

One important goal of science education is to foster students' ability to make decisions concerning socioscientific issues. In Germany, the National Educational Standards take up this issue by describing evaluation and judgement competence as a goal of chemistry education. One aim of the study presented in this paper is to analyse if the evaluation and judgement competence is a subject specific competence. The second aim of the study is to analyse which aspects influence students' decision-making on socioscientific issues. By using Rasch-analyses, regressions and structural equation models the data were investigated. The analyses show that the evaluation and judgement competence in chemistry is especially influenced by content knowledge and evaluation strategies as well as cognitive abilities. Assumed influential aspects like environmental attitudes and social desirability have a negligible influence on the decision-making competence.

**Keywords:** decision-making, socioscientific Issues, evaluation, influential aspects

### 1. Theoretical background

Decision-making is one important goal of science education because the ability to make decisions on socioscientific issues (SSI) should be fostered by the integration of scientific knowledge [1]. SSI are social issues and problems, which are related to science [2]. These issues deal with controversy topics for example global climate change, energy choice or genetically modified food [3]. All of these issues are ill structured, open ended and do not have one single solution as well as they can be negotiated from multiple perspectives [2]. By negotiate these SSI an evaluation situation is given which consists according to Poschmann, Riebenstahl, & Schmidt-Kallert [4] of a minimum of three elements. These are the object, which should be evaluated, the subject, which evaluates, and the connection between these two parts. In addition to these three elements the subject can be influenced by several external aspects (figure 1). The attitude, influenced by the aim, dependence, preference and the individual background builds a system of values of the subject, which influences the subjects' behaviour.

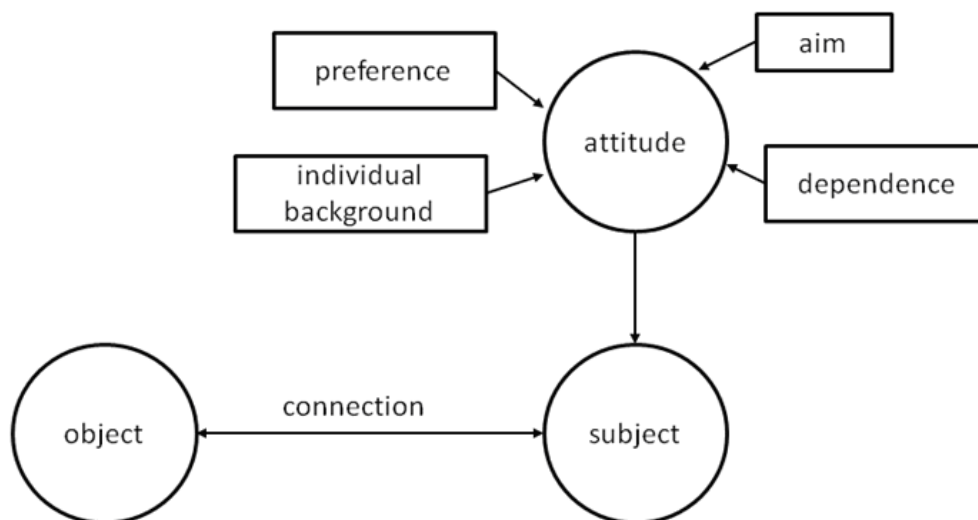


figure 1: evaluation situation [4]

The implementation of National Educational Standards aims at fostering students' decision making. The standards are implemented in school since the school year 2005/2006 and they define learning outcomes, students should have acquired when they graduate and leave school. The standards describe four different areas of competence (content knowledge, acquisition of knowledge, communication, evaluation and judgement). The present study investigated decision-making in science within the framework of the *evaluation and judgement competence* [5].

Because of the fact, that an evaluation is always influenced by the subjects' system of values (figure 1), it can be assumed that there are additional external aspects which influence the *evaluation and judgement competence*. Recent research projects showed that high content knowledge affects the quality of argumentation [6] and showed a relation between content knowledge and the negotiation of SSI [7]. In addition to that, it can be assumed that social desirable responding could have an influence on students' answers in surveys [8]. To assess the evaluation and judgement competence tasks are used which contain environmentally conscious behaviour. By expectation of an environmentally conscious behaviour, corresponding attitudes are assumed [9]. Critical thinking is one requirement for the *evaluation and judgement competence* and contains the evaluation of data quality [10] and students need to know evaluation strategies and they have to apply evaluation strategies to evaluate precisely. These external aspects are not part of the *evaluation and judgement competence* itself but may be important influencing aspects. They can be divided into the three following categories:

1. Subject-related aspects, which include the content knowledge and the application of content knowledge, related to the topics of the items.
2. Interdisciplinary aspects, which include knowledge and application of evaluation strategies and estimation of data quality.
3. Personal aspects, which include individual attitudes, social desirability and cognitive abilities.

## 2. Aims of the study

First aim of the presented study was to compare the subjects chemistry and biology in order to investigate if a chemistry specific *evaluation and judgement competence* can be separated from other subjects or everyday life situations. The second aim of the study was to analyse influential aspects on the decision-making process (e.g. content knowledge, cognitive abilities, knowledge of strategies).

## 3. Methods and Instruments

For data collection a quantitative empirical design was used. To assess the *evaluation and judgement competence* in chemistry and in biology students had to work on paper-pencil-tests. The items with constructed with guidelines due to a model of competence [11]. In the test items students were asked to identify criteria to make a decision in controversial situations, to use evaluation strategies and to reflect decisions. Additionally, tests concerning the assumed influential aspects were used. The time needed by students to fill out the tests was 180 minutes and data was collected on two days.

## 4. Results

The study was realised at 29 classes from 10<sup>th</sup> and 9<sup>th</sup> grade of German upper track secondary schools with a sample size of 777 students. By using Rasch-analyses, regressions and structural equation models the data were investigated.

To investigate if the evaluation and judgement competence is a subject specific competence a uni-dimensional Rasch analysis was done, in which the items of the evaluation and judgement competence in chemistry, in biology and in everyday life contexts were used. This analysis is compared with a three-dimensional analysis, where every test is assumed to build one single latent dimension.

**table 1:** Results of the Rasch-analyses

	Uni-dimensional	Three-dimensional
Deviance	16110.96	16015.62
Separation Reliability	0.994	0.994
EAP/PV Reliability	0.73	Dimension 1 (application of evaluation strategies): 0.47 Dimension 2 (Chemistry): 0.68 Dimension 3 (Biology): 0.65

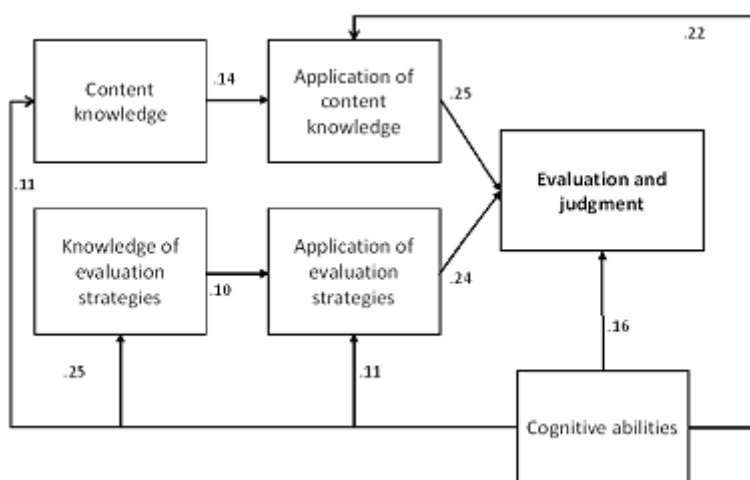
All items fit in the model regarding the criteria MNSQ and t-value [12]. The Rasch-analyses (table 1) show that the competence of decision-making on SSI is a domain-specific competence. The deviance and the information criteria (AIC, BIC, CAIC) are lower by using a more-dimensional model. In addition to that latent correlations were calculated which show a connection between the three dimensions and also show that the dimensions represent not the same competence (table 2).

**table 2:** Latent correlations

	Evaluation strategies	Chemistry	Biology
Evaluation strategies	1	0.547	0.672
Chemistry	0.547	1	0.885
Biology	0.672	0.885	1

The calculation of multiple regression show that the decision-making competence in chemistry is especially influenced by the application of evaluation strategies in everyday life ( $\beta = .21$   $p \leq .001$ ) the application of content knowledge in chemistry ( $\beta = .19$   $p \leq .001$ ) and the cognitive abilities ( $\beta = .12$   $p \leq .05$ ). Influential aspects like environmental attitudes and social desirability have a negligible influence on the decision-making competence. Only 22 % of the variance can be explained with the assumed external aspects.

In addition to that the calculation of a structural equation model shows the interaction between some influential aspects and fits the criteria of quality (RMSEA = .05, CMIN/df = 2.42, SRMR = .03, CFI = .96).

**figure 2:** Structural equation model



The structural equation model shows that there are two paths with the highest influence on the evaluation and judgement competence. Content knowledge and evaluation strategies have to be known before they can be applied. By including the other influential aspects in the calculation, it does not fit the quality criteria anymore.

## 5. Conclusion

The presented study provides empirical data for a closer description of decision-making in case of the *evaluation and judgement competence* and shows which aspects have an influence on the decision making. These results can be used to foster the ability to make decisions in chemistry specific contexts. Additionally, different test instruments for measuring the *evaluation and judgment competence* and influential aspects were developed.

## 6. References

1. Sadler, T. D., & Zeidler, D. (2005). Patterns of informal reasoning in the context of socioscientific decision-making. *Journal of Research in Science Teaching*, **2005**, 42(1), 112–138.
2. Sadler, T. D., Barab, S. A., & Scott, B. (2007). What Do Students Gain by Engaging in Socioscientific Inquiry. *Research in Science Education*, **37**, 371–391.
3. Albe, V. (2008). Students' positions and considerations of scientific evidence about a controversial socioscientific issue. *Science & Education*, **17**(8-9), 805–827.
4. Poschmann, C., Riebenstahl, C., & Schmidt-Kallert, E. (1998). *Umweltplanung und –bewertung [planning and evaluation of environment]*. Gotha: Justus Perthes Verlag.
5. KMK. (2005). Bildungsstandards im Fach Chemie für den Mittleren Schulabschluss [Educational standards in chemistry for the general educational school-leaving certificate after grade 10]. Neuwied: Luchterhand.
6. Aufschnaiter, C. von, Erduran, S., Osborne, J., & Simon, S. (2008). Arguing to Learn and Learning to Argue: Case Studies of How Students' Argumentation Relates to Their Scientific Knowledge. *Journal of Research in Science Teaching*, **45**(1), 101–131.
7. Uskola, A., Maguregi, G., & Jiménez-Aleixandre, M.-P. (2010). The Use of Criteria in Argumentation and the Construction of Environmental Concepts: A university case study. *International Journal of Science Education*, **32**(17), 2311–2333.
8. Sedlmeier, P., & Renkewitz, F. (2008). *Forschungsmethoden und Statistik in der Psychologie*. (Research methods and statistics in Psychology). *Psychologie*. München: Pearson Studium. Retrieved from <http://www.gbv.de/dms/ilmenau/toc/514026561.PDF>
9. Kaiser, F. G., Wölfing, S., & Fuhrer, U. (1999). Environmental Attitude and Ecological Behaviour. *Journal of Environmental Psychology*, **(19)**, 1–19.
10. Astleitner, H., Brünken, R., & Zander, S. (2002). Können Schüler und Lehrer kritisch denken? Lösungserfolg und -strategien bei typischen Aufgaben. (Can students and teacher think critically?). *Salzburger Beiträge zur Erziehungswissenschaft*, **(6)**, 51–61.
11. Hostenbach, J., Fischer, H. E., Kauertz, A., Mayer, J., Sumfleth, E. & Walpuski, M. (2011). Modellierung der Bewertungskompetenz in den Naturwissenschaften zur Evaluation der Nationalen Bildungsstandards. (Modeling the evaluation and judgement competence in science to evaluate national educational standard) *Zeitschrift für Didaktik der Naturwissenschaften*, **17**, 261–288.
12. Wilson, M. (2005). *Constructing measures: An item response modeling approach*. Mahwah, N.J: Lawrence Erlbaum Associates.

## Ontological Representations in Solving Stoichiometry Problems in Chemistry Education

Tamara HRIN, Mirjana SEGEDINAC, Jasna ADAMOV, Saša HORVAT

*Faculty of Sciences, University of Novi Sad  
Trg Dositeja Obradovi a 3, 21000 Novi Sad, Serbia  
tamara.hrin@neobee.net +381642786311*

### Abstract

*This paper gives a survey of ontologies used for representation of stoichiometry problems and their solutions. This approach to knowledge representation uses real maps of knowledge in the form of modified graphs that reflect the structure of certain scientific and educational content. Following The Systemic Approach to Teaching and Learning Chemistry (SATLC), which was based by Fahmy and Lagowski in 1997<sup>th</sup>, we created systemics for one chemical teaching unit – Stoichiometry. Our examples of systemics include two types of stoichiometry problems in terms of complexity: basic problems and more complex composite problems. Some of examples are shown and their efficiency further explained.*

**Keywords:** knowledge representation, ontology, concept map, SATLC, systemic, stoichiometry

### Introduction

The new century generation has challenges that are difficult and numerous, either to find place in this universe or the international flood of science and knowledge will take them away [1]. The world today is characterized by scientific and technological progress. Scientific innovations have influence to almost all economical, social, medical and educational aspects. Therefore, the role of educational institutions is very important in helping learners to make use of these changes [2]. So, it is necessary for us to take a revolution in the methods of teaching, which have to follow flexibility of science education, with an aim to create a reorganized generation able to see what is going on around the world, and at the same time we must not lose real identity of pupils.

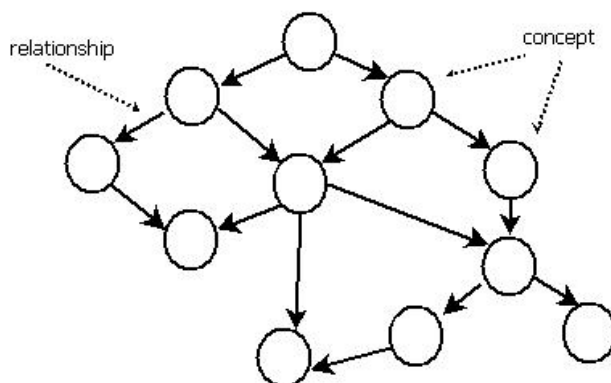
A good method of teaching must create rich and stable knowledge-based system, and in chemistry this system comprises: chemical scientific theories, chemical laws, chemical scientific concepts and facts. When we form a stable knowledge-based system, we can continue with growth of knowledge (learning new information relevant to information already understood), that is referred as quality of education. But pupils usually say that learning chemistry is a demanding task. Its abstract nature (structural concepts, symbolic language, quantitative/mathematical character) not only causes difficulties to many students, but also contributes to making it an unpopular subject [3]. Many of the features listed here can be attributed to the stoichiometry, and because of that solving of quantitative problems present an area of difficulty for many pupils in primary and secondary school. So, the main questions are: *What we can do to motivate pupils to learn stoichiometry and become better problem solvers? How to make it closer to them? How we can improve our instructions? How can be overcome differences between skilled and less skilled pupils? And on the other hand, how can be form stable knowledge-based system?*

In response to these questions we propose ontological knowledge representations, and Systemic Approach to Teaching and Learning (SATL) as a sub branch of ontological representations.

### Ontological knowledge representations in chemistry

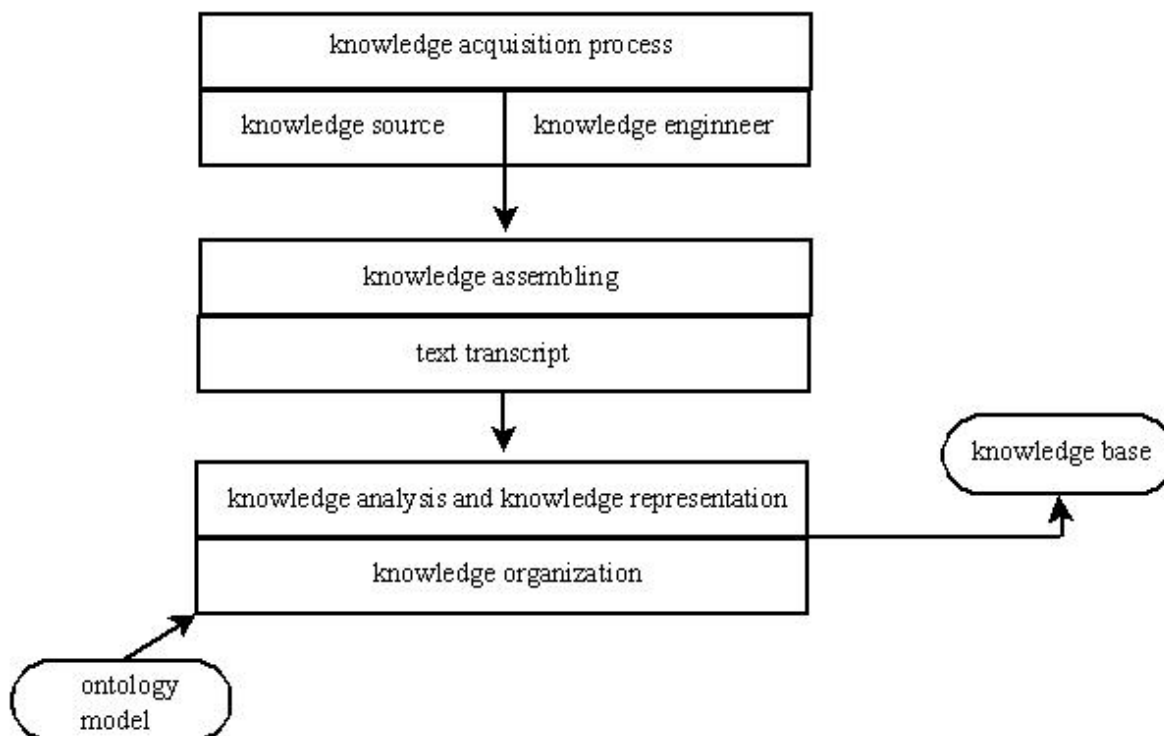
The word “ontology” may be used in different ways [4,5]. Ontology has a long history in philosophy, some authors emphasize that it is borrowed from philosophy [5,6], in which it refers to the subject of existence (systematic account of existence). It is study or concern about what kinds of things exist, what entities or things there are in the universe. But in the context of knowledge sharing, by Gruber ontology is

an explicit specification of a conceptualization. For knowledge-based systems, what “exists” is explicitly that which can be represented [7]. “An ontology is a vocabulary of entities, classes, properties, functions and their relationships” [8], or “An ontology is a set of definitions of content-specific knowledge representation primitives: classes, relationships, functions, and object constants” [5,9]. From those definitions we can see that the main components of the ontological model are: concepts, relations among them and set of instances which specify concepts. **Figure 1** shows an example of ontological graph.



**Figure 1:** Ontological graph with main components

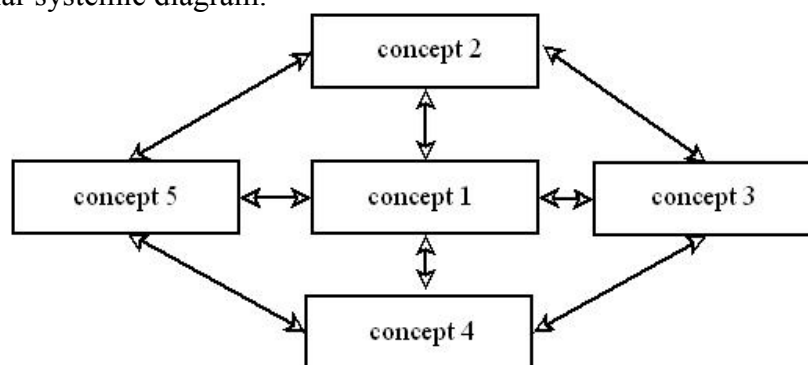
An ontology is a specific organization of the conceptual knowledge in a given field [5]. Today we can see an explosion of interest in ontologies as artifacts to represent human knowledge and as critical element in knowledge management, the Semantic Web, business-to-business applications, and several other application areas [10]. Although the field of applying ontological research in education is fairly young, it is already quite broad and fuzzy [11]. First workshop dedicated to this topic was organized in 1999. When we look at main characteristics of an ontology, we can ask ourselves: How we can apply ontology in science education to help pupils in learning process? We would explain it with **Figure 2**, with knowledge acquisition process.



**Figure 2:** Ontology in the knowledge acquisition process

An important step in developing a knowledge-based system is knowledge acquisition, which refers to the three stages of knowledge assembling, knowledge analysis and knowledge representation [12]. Effective knowledge analysis and representation need knowledge organization, which can be improved with *ontology model*. After that, all our knowledge can be put to knowledge base.

As a one type of ontological knowledge representation, we can display Systemic Approach to Teaching and Learning Chemistry (SATLC), which was designed, implemented and evaluated by Fahmy and Lagowski in 1997<sup>th</sup>. They have set up this approach after the sudden expansion of globalization in wide range of human activities such as economics, media, politics, and entertainment. They find that using systemics people can learn in all areas of human activities, in order to obtain more global view of important relations in science, and to understand how science affects other human activities. This approach which affects both teaching and learning, uses modified graphs, more precisely modified concept maps – systemics. “Systemic” mean an arrangements of concepts and issues through interacting systems in which all relationships between concepts and issues are made clear to the learner [13]. **Figure 3** shows one particular systemic diagram.



**Figure 3:** Systemic representation which stresses all existing relationship between concepts

We choose systemics like teaching and learning tools because many studies indicates that applying systemic approach in the process of teaching can improve the output of that process (for further information see reference [2]). Systemics can help pupils in many ways:

- in development of their mental framework – especially in high cognitive processes such as analysis, synthesis, reasoning
- with understanding interrelationships of concepts in greater context
- to exhibit a more global view of core science relationships (for us especially chemical subjects)
- to improve their understanding
- to aid learning by explicitly integrating new and already adopted knowledge

These graphical tools are very convenient for organizing and representing knowledge, and have strong psychological and epistemological background, like modified concept maps. This background is based by Ausubel’s and Novak’s theories. David Ausubel stressed the importance of prior knowledge in being able to learn about new concepts, and Novak concluded that meaningful learning involves the assimilation of new concepts and propositions into existing cognitive structures [14]. Our brain organizes knowledge in hierarchical structure (concept maps do the same thing) and thereby further facilitates the learning process. On the other hand, mechanically accepted knowledge is quickly forgotten, because it is stored in short-term memory, and students do not acquire the ability to reuse knowledge in future learning or for solving various problems [15].

Some authors and researchers, for example Johnston and Otis concluded that a map is very personal thing, idiosyncratically constructed for the sole benefit of the individual student [15]. A number of observations on attempts to “score” concept maps suggest that they are not good assessment tools, mostly because there are many possible concept maps that “correctly” show the relationship among given collection of concepts. It can be said that systemic have taken all good features of concept maps, and also improve or eliminate the disadvantages. Fahmy and Lagowski point out that it is more difficult to obtain a

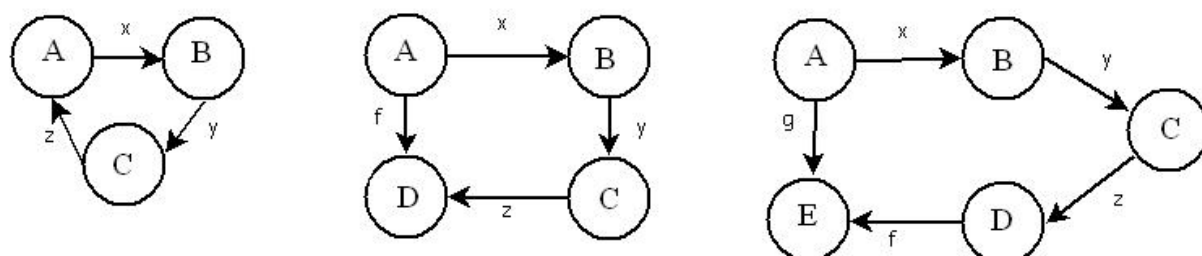
global view of collection of linearly arranged concept, than with the systemic representation [13]. Systemic is powerful teaching and learning tool because it is a foundation upon which knowledge is organized in a structure where concepts interact and form a net of knowledge. So, it help learner to deduce new relations that enrich the operation of teaching and learning from its cognitive, psychomotor and emotional sides. It is metacognitive resource that help both students and teachers to improve the process of learning, teaching and training.

### The Application of Systemics in Teaching Stoichiometry

Our systemic are presented for one chemical teaching unit – Stoichiometry, with an aim of transforming surface learning to deep learning which can be use in different situations during education and future work. Stoichiometry is regarded as one of the fundamental “tools in the chemistry toolbox” [16,17] because attainment of high degree of proficiency in solving stoichiometry problems is needed for dialing with equilibrium and acid-base problems [17].

But there are many concepts in stoichiometry that are very abstract to the learners and learners can quickly lose interest in learning. Establishing the links among the concepts of stoichiometry is most important task in developing deep learning. However, whilst the motivational problem is easily addressed at the beginning, it must be reinforced during the whole process, because it is only after students know and understand all of those links they have the ability to successfully resolve the real problems [18]. In addition to motivational problems, means of instruction and teacher instruction play an important role in the process of training and learning stoichiometric content. The current of instruction, in which abstract stoichiometry procedures are taught detached from their use in real-world chemistry and held in abeyance for future use, is not working [19]. And on the other hand, manner in which stoichiometry is explicated to students presents still another challenge to its learning.

In terms of complexity, quantitative problems in subject such as chemistry and physics are of two kinds [20]. First there are *basic problems* which require a small number of steps to solve them, and there are *composite problems* which require multi-step procedures for obtaining a solution. Composite problem usually consists of a number of the basic problems linked together. And, in terms of nature of the problems, there are *problems based on shown chemical formula* and *problems based on shown chemical equation*. To solve these problems, pupils have difficulties, such as: (a) decomposing composite problems. When pupils get one composite problem they don't know how to decompose it in smaller basic problems, and to them this composite problem become one big basic problem for which they don't have solution. (b) using some strategy to obtain a solution (c) representing the problem in right way (d) linking elements of the problem description and the knowledge base. To overcome these difficulties, we choose to create systemics. Systemics can be applied in teaching process, represented in different forms (**Figure 4** shows some particular systemic diagrams) and main task of these graphs is to show all existing connections between concepts and thus allow connections of new concepts with those already existing in the knowledge base.



**Figure 4:** Particular systemic diagrams with three, four and five concepts  
A, B, C, D, E are concepts and x, y, z, f, g are relations among them

In **Figure 5** we present systemic for task with one basic problem, based on shown chemical equation. Basic Problem: “How many moles of aluminum will react with 2 moles of iodine to produce aluminum(III)-iodide?”

To solve this basic problem we present our systemic (Figure 5) which will help pupils to see and understand all existing relationships between important concepts. They don't have to memorize all expressions to calculate required units, they will learn it filling out empty spaces in systemic. It is significant advantage of systemic representation, when we compare it with traditional linear way of representing knowledge.

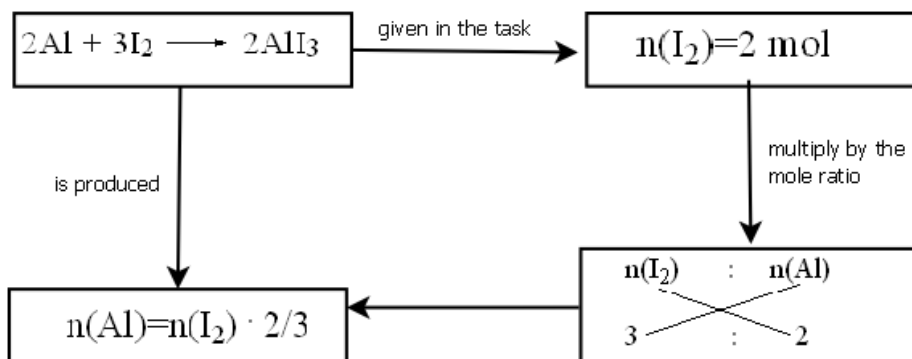


Figure 5: Systemic for task with one basic problem

Probably it is more important present composite problems with systemics, because pupils have significant problems with decomposing these problems. With using systemics they learn how to decompose and reorganize complex problems. Figure 6 shows systemic for task with composite problem, based on shown chemical equation.

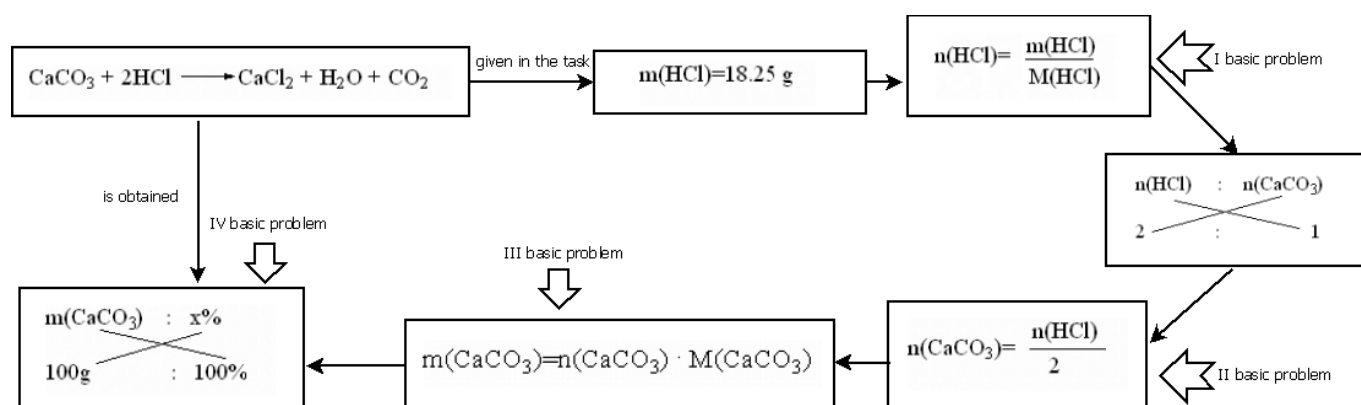


Figure 6: Systemic for task with composite problem, which consists of four basic problems

A unit like this, presented with systemics like graphical tools for knowledge representation, can encourage and motivate pupils to find solutions for the real life problems such as problems of recycling, producing environmentally friendly materials, turning gas flaring into domestic and industrial fuel etc. It is one of the means of preparing students for future endeavor and careers [21]. We can say that if students understand these systemics, they will facilitate future learning, primarily because chemical processes, chemical equations and reactions are necessary for the calculations of laboratory and industrial obtaining many essential substances.

### Conclusions and future work

One of the main goals of learning and training in chemistry education is development of effective methods and strategies used to create a system of scientific chemical knowledge. Relying on the principles established by Novak, Fahmy and Lagowski, progress in the understanding of chemical facts, and increasing success in acquiring new and unknown chemical entities by students can be achieved by using systemics. Systemic arrangement of these concepts and conclusions in the system in which the connections between concepts and conclusions are strongly pronounced, allows the realization of such

quality of knowledge. Their great advantage is clearer and more efficient structuring of learning material, and planning of the teaching process. This inter-connection between the concepts provides a strong natural connection, which improves the quality and quantity of students' knowledge, facilitates teachers' time articulation of classes and successful transfer of knowledge to students.

Because of these numerous advantages, we will apply SATL (Systemic Approach in Teaching and Learning) technique in our research and determine the effect of teaching by systemic approach in students' achievement in stoichiometry teaching unit. We will form experimental and control groups with seventh grade pupils. In Serbia, those pupils are twelve to thirteen years old. Experimental group will be learning with systemics, but control group will be learning with linear representation (conventional approach). In our research, we will examine differences in achievement of experimental and control group, precisely we will reveal if there is significant statistical differences in the students achievement in favor of experimental group. Also it is important to establish possibility of reducing the functional fixation with using systemics, and advantage of algorithms in teaching process. One of the main goals of our research will be determination of dependence of pupils achievement on cognitive load, as well as how can be overcome big differences between skilled and less skilled pupils, or whose pupils (skilled or less skilled) prefer learning with systemics.

With this research we wish to reiterate many of advantages of using systemics, and to discover some new ones.

**Acknowledgement:** This work has been supported by Grant No. 47003 from the Ministry of Education and Science of the Republic of Serbia.

## References

- [1] A.F.M. Fahmy, J.J. Lagowski, The Use of Systemic Approach in Teaching and Learning Chemistry for the 21<sup>st</sup> century, *Pure and Applied Chemistry*, 1999, **71** (5), pp. 859-863
- [2] Z. Al-bashaireh, Systemic Approach Effect on Achievement on Tafila Schools Students in Sciences, *International Journal of Humanities and Social Science*, 2011, **1** (3), pp. 47-52
- [3] G. Tsaparlis, Globalization in Chemistry Education Research and Practice, *Chemistry Education: Research and Practice*, 2003, **4** (1), pp. 3-10
- [4] N. Guarino, P. Giaretta: Ontologies and Knowledge Bases Towards a Terminological Clarification. In: N.J.L. Mars, *Towards Very Large Knowledge Bases: Knowledge Building & Knowledge Sharing*, pp. 25-32, IOS Press, Amsterdam, Netherlands, 1995
- [5] F. Deloule, C. Roche, Ontologies & Knowledge Representation, IEEE International Conference on Systems, Man and Cybernetics: Intelligent Systems for the 21<sup>st</sup> Century, Vancouver, British Columbia, Canada, October 1995, p. 3857
- [6] T.R. Gruber, Toward principles for the design of ontologies used for knowledge sharing, *International Journal of Human-Computer Studies*, 1995, **43**, pp. 907-928
- [7] T.R. Gruber, A Translation Approach to Portable Ontology Specifications, *Knowledge Acquisition*, 1993, **5** (2), pp. 199-220
- [8] A. Aldea, R. Bañares-Alcántara, J. Bocio, J. Gramajo, D. Isern, A. Kokossis, L. Jiménez, A. Moreno, D. Riaño, An Ontology-Based Knowledge Management Platform, ArnetMiner: [www.arnetminer.org/publication/an-ontology-based-knowledge-management-platform-387346.html](http://www.arnetminer.org/publication/an-ontology-based-knowledge-management-platform-387346.html), Accessed 31. July 2012.
- [9] T.R. Gruber, Ontolingua: a mechanism to support portable ontologies. *Technical Report KSL 91-66*, 1992, Stanford University, Knowledge System Laboratory. Revision
- [10] C. Brewster, K. O'Hara, Knowledge Representation with Ontology: The Present and Future, *Intelligent Systems, IEEE*, 2004, **19**, pp. 72-81
- [11] D. Dicheva, P. Brusilovsky, T. Gavrilova, P. Brusilovsky, Ontological Web Portal for Educational Ontologies, Workshop on Applications Of Semantic Web Technologies for E-Learning, The 12<sup>th</sup> International Conference on Artificial Intelligence in Education, Amsterdam, July 2005, p. 19-27
- [12] L.L. Chen, C.W. Chan, Ontology Construction from Knowledge Acquisition, Pacific Knowledge Acquisition Workshop (PKAW), Sydney, December, 2000
- [13] A.F.M. Fahmy, J.J. Lagowski, Systemic Approach to Teaching and Learning Chemistry: SATLC in Egypt, *Chemical Education International*, 2002, **3**
- [14] J. Adamov, M. Segedinac, S. Cvjetićanin, R. Bakoš, Concept Maps as Diagnostic Tools in Assessing the Acquisition and Retention of Knowledge in Biochemistry, *Odgovorne Znanosti*, 2009, **11** (1), pp. 53-71
- [15] J.D. Novak, Meaningful Learning: The Essential Factors for Conceptual Change in Limited or Inappropriate Propositional Hierarchies Leading to Empowerment of Learners, *Science Education*, 2002, **86**, 548-571

- [16] K.L. Evans, G. Leinhardt, M. Karabinos, D. Yaron, Chemistry in the Field of Chemistry in the Classroom: A Cognitive Disconnected? *Journal of Chemical Education*, 2006, **83**, 665-671
- [17] A.E. Okanlawon, Constructing a Framework for Teaching Reaction Stoichiometry Using Pedagogical Content Knowledge, *Chemistry*, 2010, **19** (2), pp. 27-44
- [18] Z. Xia, Thinking Towards Teaching Physical Chemistry in China: How to Increase the Learning Interest in This Course, *China Papers*, (2), pp. 25-27
- [19] K.L. Evans, D. Yaron, G. Leinhardt, Learning stoichiometry: a comparison of text and multimedia formats, *Chemistry Education Research and Practice*, 2008, **9**, pp. 208-218
- [20] R. M. Heyworth, Quantitative problem Solving in Science: Cognitive Factors and Directions for Practice, *Education Journal*, 1998, **26** (1), pp. 13-29
- [21] E.M. Alake, K.O. Oloruntagbe, Chemistry for Today and the Future: Sustainability Through Virile Problem-based Chemistry Curriculum, *Australian Journal of Basic and Applied Sciences*, 2010, **4** (5), pp. 800-807



# Development of Teaching Material Based on Computer Graphics by Quantum Chemistry Calculation

Akira IKUO, Haruo OGAWA

Department of Chemistry, Tokyo Gakugei University, 4-1-1 Nukuikitamachi, Koganei, Tokyo 184-8501, Japan  
E-mail: ikuo@u-gakugei.ac.jp

## Abstract

*Visualization of computer graphics (CG) based on quantum chemical calculation is great help for student to have images of phenomena, chemical concepts, and molecular world. It is our aim to produce CG teaching material (CG-TM), which provides realizable images of the nature of chemical reaction. We developed CG-TM of chemical reaction for university student, which can be used to desktop, laptop, and tablet computers, as well as smart phone. MOPAC with PM3 or PM5 Hamiltonian was used in all of calculations. The CG-TM of  $F + HCl \rightarrow HF + Cl$ ,  $CH_3Cl + OH^- \rightarrow CH_3OH + Cl^-$ , and esterification of acetic acid and ethyl alcohol were produced. The CG-TM could simultaneously display realistic shapes and electrostatic potentials of reactants on the way of the reaction profile besides the ball-and-stick model. The CG-TM could be an effective tool to provide information about the nature of the reaction.*

**Key words:** Visualization of chemical reaction, HCl, Walden's inversion, esterification, teaching material, quantum calculation

## 1. Introduction

Visualization of computer graphics (CG) based on quantum chemical calculation is great help for student to have images of phenomena, chemical concepts, and molecular world. It is our aim to produce CG teaching material (CG-TM), which provides realizable images of the nature of chemical reaction. We developed CG-TM of chemical reaction for university student, which can be used to desktop, laptop, and tablet computers, as well as smart phone. This paper introduces our works of CG visualization of fundamental chemical reactions for realizing certain images of the reaction mechanism.

## 2. Procedure

### 2.1 Quantum chemical calculation

The semi-empirical molecular orbital calculation software MOPAC[1] with AM1, PM3, and PM5 Hamiltonians in CAChe Work System for Windows (ver. 6.01, FUJITSU, Inc.) was used in all of calculations for optimization of geometry, for search of potential energies of various geometries of intermediates, for search of transition state, and search of the reaction path from the reactants to the products *via* the transition state. The optimized structure of the transition state was verified by the observation of a single absorption peak in the imaginary number by the use of the program Force in MOPAC[1] for vibration analysis. If the peak was observed, Intrinsic Reaction Coordinate (IRC) [2] calculation was done and the reaction path was confirmed.

### 2.2 Production of CG teaching material

A movie of the reaction path was produced by the software DIRECTOR (ver. 8.5.1J, Macromedia, Inc.) or Flash CS4 software (Adobe, Inc.) following the display of the bond order of the structure of the reactants in each reaction stage, which was drawn by the CAChe. It was confirmed that the Cast members were arranged on the stage and the molecular models of reactants moves smoothly. The ball was arranged on the reaction profile and the movement of the ball and the reactants was confirmed. The movie file was

converted to the Quick Time movie by the Quick Time PRO (ver. 7.66, Apple, Inc.) and was saved to iPad (Apple, Inc.) and iPhone 4 (Apple, Inc.), by using the iTunes (Apple, Inc.).

### 3. Results and discussion

#### 3.1 Reaction of $F + HCl \rightarrow HF + Cl$

The study of simple reaction of two atoms molecule on the reaction of  $F + HCl \rightarrow HF + Cl$  was conducted by the calculation of potential energy (PE). Changes of PE in the reaction have been reported experimentally[3] and theoretically[4]. However, the reaction has not been clarified enough in details such as PE surface in three-dimension (3-D). PE of 2-D and 3-D are shown in figure 1 along with structure of reactants in ball-and stick model and the reaction profile, which demonstrates the degree of the reaction progress by the ball. The transition state is located near the point of H-F distance of 1.376 Å and H-Cl distance of 1.354 Å. The IRC method[2] supported the transition state. A single absorption peak in the negative region was found at  $-2858 \text{ cm}^{-1}$ . The result indicates vibrational mode due to the decrease of potential energy for the direction of only one path *via* a true transition state at the saddle point. Energy between the initial state of reactants and the final state of products was  $38.96 \text{ kcal mol}^{-1}$ . The value was in fairly good agreement with an experimental[3] value of  $33.06 \text{ kcal mol}^{-1}$ . The figure 1 clearly shows these changes of PEs with display on PE surface in 3-D, which offers a bird-eye view of the reaction profile. Two Valleys of lower energies and hilltop on the transition state at the saddle point can be recognized boldly. Possible pathways of the reaction from the reactants of F and HCl to the products of HF and Cl *via* the transition state at saddle point can be readily traced. CG-TM is able to provide information about change of the PE and structure of reactants in a certain state simultaneously.

#### 3.2 Reaction of $I + H_2 \rightarrow HI + H$

We developed a CG-TM of rearrangement by collision of diatomic molecule and one atom. The transition state of the reaction is located hereby the point of 1.65 of I-H distance and 1.80 of H-H distance. The electrostatic potential on electron density (EPED) model and ball-and-stick model of the intermediate, I-H-H, and the reaction profile were combined in the left side of figure. 2 for easier recognition of those three. The electrostatic potential[5] was calculated based on the coordinates of atoms from the IRC calculation[2] and superimposed on to the iso-surface of the electron density at the value of  $0.01 \text{ e } \text{Å}^{-3}$  as shown in the upper left part of the CG. The values of electrostatic potentials were represented in different color on the model of intermediate on the way of the reaction, and figure legend of color boundaries for electrostatic potential was also listed. Distribution of the electrostatic potential among the intermediate can be seen by the colors. For example, right side of  $H_2$  molecule is positively charged with relative value of +0.09 based on evaluation of energy of interactions of proton to the charge of iso-surface. The model by EPED provides information about electrostatic distribution in intermediate with realistic shape on the way of the reaction. In the middle of CG, skeletal structure in the ball-and-stick model in which diameter of the stick reflects calculated bond order is shown. Lower left part of the CG shows the reaction profile which demonstrates the degree of the reaction progress by the ball indicates PE *vs.* reaction coordinate. Learner could corrate this reaction profile with the reaction path in the right side of CG. The left side of the CG is able to provide information about characteristics of intermediate of molecule in a certain state on the progress of reaction.

#### 3.3 $OH^- + CH_3Cl \rightarrow CH_3OH + Cl^-$

Structural change of reactants in the reaction,  $OH^- + CH_3Cl \rightarrow CH_3OH + Cl^-$ , as a model of Walden's inversion is shown in scheme 1. CG-TM could demonstrate dynamism of structural change.

The inter-atomic distances of C-Cl in  $CH_3Cl$  was calculated as 1.87 Å (1.87 Å) [6], and C-O in  $CH_3OH$  was 1.41 Å (1.43 Å).[7] These values were in good agreement with the literature values in the parentheses.

Energy between the initial state of reactants and the final state of products was  $165.01 \text{ kJ mol}^{-1}$ .

The value was in fairly good agreement with literature [8] value of  $162.90 \text{ kJ mol}^{-1}$ .

Selected picture of CG movies are shown in the figure 3. The CG shows the reaction profile, which demonstrates the degree of the reaction progress by the ball indicating potential energy vs. reaction, coordinate. Movies were made by using not only the space filling model which shows realistic shape but also the ball-and-stick model which shows change in molecular configuration easily. A student is expected to obtain the image of an umbrella reverse like motion in Walden's inversion. In the space filling, the existence probability of the electron is 90 %. In the ball-and-stick, the thickness of stick changes by bond order.

When the CG is touched by student, the Quick Time control bar appears and the red ball can move by student's choice. This manual control feature provides "Hands-on" feeling to learner. This CG teaching material could provide not only images of energy change during reaction but also images of dynamical structure change during chemical reaction.

The CG-TM could demonstrate the structural change of reactants with both space filling and ball-and-stick models along with the reaction profile, which can provide image of energy change during the reaction. The CG-TM can be loaded with note PC, tablet PC, and smart phone.

### 3.4 Esterification of acetic acid and ethyl alcohol

CG-TM of the esterification of acetic acid and ethyl alcohol is shown in figure 4. The electrostatic potential[5] was calculated based on the coordinates of atoms and superimposed on to the iso-surface as shown in figure 4. The values of electrostatic potentials were represented in different color on the model of intermediate in the transition state, and figure legend of color boundaries for electrostatic potential was also listed. Distribution of the electrostatic potential among the intermediate can be seen by the colors. For example, oxygen of ethanol is negatively charged with relative value of  $-0.06$  based on evaluation of energy of interactions of proton to the charge of iso-surface, and hydrogen of carbonium ion is positively charged with relative value of  $+0.09$ . The model by electrostatic potential provides information about electrostatic distribution of the intermediate on the way of the reaction. The CG-TM could simultaneously display realistic shapes and electrostatic potentials of reactants on the way of the reaction profile besides the ball-and-stick model as shown in figure 5. The CG-TM can play by student's choice of the way of automatic movement or manual movement. The CG-TM in tablet computer could be used in the laboratory to provide images of chemical reaction.

## 4. Conclusion

In this work, the change in the molecular configuration of chemical reaction made visible from the quantum chemistry calculation. The CG teaching material enabled to load with note PC, tablet PC, and smart phone. The CG-TM in tablet PC could be an effective tool to provide information about the nature of the reaction.

## Acknowledgements

This work was supported by JSPS Grant-in-Aid for Scientific Research (C) (22500803).

## References

- [1] a: Stewart, J. J. P., **1989**, *J Comp. Chem.*, 10, 209–220; b: Stewart, J. J. P., **1989**, *J. Comp. Chem.*, 10, 221– 264; c: Stewart, J. J. P., **1991**, *J. Comp. Chem.*, 12, 320–341.
- [2] Fukui, K., **1970**, *J. Phys. Chem.*, 74, 4161-4163.
- [3] Martin, J. D. D. and Hepburn, J. W., **1998**, *J. Chem. Phys.*, 109, 8139-8142.
- [4] Deskevich, M. P., Hayes, M. Y., Takahashi, K., Skodje, R. T. and Nesbitt, D. J., **2006**, *J. Chem. Phys.*, 124, 224303-1-224303-12.
- [5] Kahn, S. D., Pau, C. F., Overman, L. E. and Hehre, W. J., **1986**, *J. Am. Chem. Soc.*, 108, 7381-7396.
- [6] Robert C. Weast, **1982**, "CRC Handbook of Chemistry and Physics" 63rd Ed., CRC Press, Inc, F180-181.
- [7] S. Shida, **1981**, "Kagakujiten", Morikitasuyuppan, p.1251.
- [8] Nihonkagakukai-hen, "Kagakubinran Kisohen" 3rd. Ed., Maruzen, **1984**, II-314.

## The Impact of the TEMPUS-project SALiS from the Perspective of an Eastern European Country

Marika KAPANADZE and Simon JANASHIA

*Ilia State University, 3/5 Cholokashvili Ave, Tbilisi, 0162, Georgia  
marika\_kapanadze@iliauni.edu.ge, tel. +995 32 2 22 73 09*

### Abstract

*SALiS is a cross-regional project funded within the TEMPUS program of the EU. SALiS (Student Active Learning in Science) envisages strengthening the capacities of the partner institutions from the EU, Georgia, Moldova and Israel to promote contemporary science education by investments in reform in science teacher training. The focus is to support societally relevant, inquiry-based, and student-active science teaching and learning. SALiS aims at innovating science teaching through a better inclusion of inquiry-based and student-active experimental learning in science classes by investing in pre- and in-service science teacher training. This paper gives an overview about the development and results of SALiS in Georgia and in Moldova.*

**Keywords:** science teacher training, inquiry-based science education, active learning, EU-projects, SALiS

After the collapse of the Soviet Union Moldova and Georgia are struggling to overcome a centralized and teacher-centered science education paradigm. National reforms ask for more student-active and problem-based science education by inclusion of students' hands-on and inquiry-based learning in the laboratories. Unfortunately, teaching materials and teacher training facilities are not developed well enough to sufficiently support the intentions of the reform [1].

As a response the TEMPUS-project SALiS (Student Active Learning in Science) was established. The project is led jointly by the Ilia State University in Tbilisi, Georgia, and the University of Bremen, Germany. SALiS aims at promoting science teaching through a better inclusion of student-active experimental learning in science classes. SALiS promotes inquiry-type lab-work as one of the foundations of the modern curricular and methodological approaches in science teaching to reach higher order cognitive skills, a better learning of science concepts, and to enhance the understanding of the nature of science [2].

With the help of the EU TEMPUS-program innovations in the infrastructure and teacher training were carried out in two east European countries – Georgia and Moldova. New laboratories for science teacher training were established and equipped at Ilia State University and Kutaisi State University, also at the University of Academy of Science of Moldova and Institute of educational Sciences in Chisinau. Curricula were changed and the staff was trained. This enables teachers to acquire knowledge and skills of inquiry-based science teaching based on active student participation with the emphasis on low-cost and microscale-laboratory techniques [3].

Staff from beneficiary universities from Georgia and Moldova visited two European Universities – Free University of Berlin, Germany and University of Limerick, Ireland.

During the visit in Berlin SALiS partners had the opportunity to attend experimental out-of-school courses with children (age 9 to 10) KiWi, seminars with practical exercises with pre-service teacher students and in-service-teacher training courses.

During the visit in Limerick SALiS partners took part in a Workshop on Chemical Demonstrations and Chemical Magic Shows with Irish teachers.

Workshops were organized in Georgia, at Ilia State University and in Moldova at the University of Academy of Science of Moldova. The workshops were conducted by all European Partners during 2011.

The materials for the workshops have been developed by the EU universities, in collaboration with other partners. These materials were translated and published in Georgian and Moldavian languages. The participants of the workshops were not only the project members and academic staff of the beneficiary universities, but also public school teachers and representatives of other universities in Georgia and in Moldova[4].

SALiS courses were piloted at Ilia State University and at the University of Academy of Science of Moldova during the spring semester 2012. After, they were evaluated. The evidence has to be used for the development of the final version of the curriculum and teaching & learning materials.

Teaching and learning materials, labguides were developed, translated and published in Georgian and Moldavian languages.

The results of the project are disseminated through the SALiS website ([www.salislab.org](http://www.salislab.org)), on international conferences in Lyon, Dortmund, Istanbul.

Five training modules will be accredited for September, 2012 and trainings for in-service Science teachers will be conducted at Ilia state University in SALiS Laboratory. These modules are:

1. Student Active Learning in Physics for basic and high school
2. Student Active Learning in Chemistry for basic and high school
3. Student Active Learning in Biology for basic and high school
4. Student Active Learning in Science for elementary school
5. Student Active Learning in Science for the 7<sup>th</sup> grade (integrated course)

Through SALiS training modules the project will reach out to the broad audience, thus enhancing the sustainability of the outcomes.

In August 2012 final conference will be held in Tbilisi, Georgia promoting the ideas of SALiS both on international and local levels.

### Acknowledgement

*We gratefully acknowledge the funding by the TEMPUS program of the EU, # 511275-TEMPUS-1-2010-1-GE-TEMPUS-JCPR (Agreement,2010-33821/001-001)*

### References

1. M. Kapanadze, S. Janashia, I. Eilks in I. Eilks & B. Ralle (eds.) *Contemporary science education*, 2010, 237.
2. M. Kapanadze, S. Janashia, I. Eilks, S. Markic, M. Stuckey. ESERA conference, Lyon, September 2011.
3. M. Kapanadze, S. Janashia, I. Eilks in I. Eilks & B. Ralle (eds.) *Contemporary science education*, 2012 (in print).
4. M Kapanadze. *Chemistry in Action*, 2012 (in print).

## Difficulties encountered by African students' learning the semiotic representations of the spatial structure of organic molecules

Destin MANGANE\*, Isabelle KERMEN\*\*

\*Univ Paris Diderot, Sorbonne Paris Cité, LDAR, EA 1547, F-75205 Paris cedex 13, France

\*\*Univ Paris Diderot, Sorbonne Paris Cité, F-75205 Paris cedex 13, France

Univ Lille Nord de France, U Artois, F-62300 Lens, France

Laboratoire de didactique André Revuz, EA 1547.

isabelle.kermen@univ-artois.fr

### Abstract

This study aims at identifying and analysing the learning difficulties of beginners regarding the semiotic representations of the spatial structure of organic molecules from a visualization perspective. The three-dimensional arrangements of atoms in molecules are depicted by two-dimensional drawings such as Cram representations or Newman projections which constitute two different semiotic systems. Treatment and conversion of semiotic representations need visuospatial abilities such as mental rotation or iconic visualization. A questionnaire was designed to determine to what extent grade 12 students in Benin (Africa) master the transformations of the semiotic representations of organic molecules. A paper-and-pencil test including four questions was administered to 340 students. The analysis of the answers revealed that a great proportion of students do not master the treatments of the Cram's semiotic representations. Most students responded randomly to say whether one or two permutations between atoms of a chiral molecule lead to the same molecule or its mirror image. No student could draw a correct staggered conformation from an eclipsed conformation which shows that the students do not master mental rotation. One third could not identify conformational isomers out of a list of six conformations because the iconic visualization is not operative. Moreover most of those who identified conformational isomers have a limited understanding of that concept. The most difficult task seems to be the conversion of a Cram representation to a Newman projection. The analysis of numerous incorrect answers leads to the assumption that spatial orientation is ineffective in most students.

**Keywords:** Semiotic representations, learning difficulties, visualization, spatial abilities, organic molecules

### Context

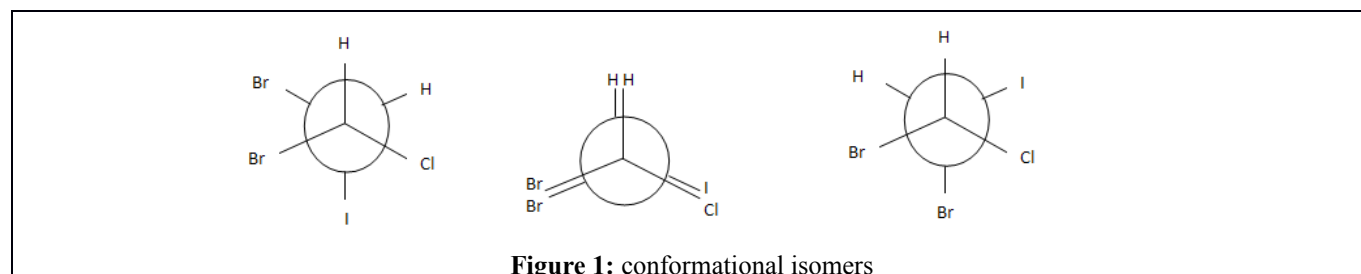
This study takes place in Benin which is a small and poor country in west Africa. Students are numerous even in upper secondary schools, about 50 or 60 per class. There are no computers, only a few ball-and-stick models. The teachers use photocopies of the reference textbook which is a French one edited in 1991 before the syllabus was designed.

### Framework of the study

Molecules are imperceptible entities; however chemists have a lot of signs and symbols to depict them and specially their spatial structure. This study aims at identifying and analysing the learning difficulties of beginners regarding the semiotic representations of the spatial structure of organic molecules from a visualization perspective. The three-dimensional arrangements of atoms in molecules are depicted by two-dimensional drawings such as Cram representations (solid wedged and hashed wedged bonds) or Newman projections. Each type of representation constitutes a semiotic system [4]. Knowing the rules, conventions and symbols of each type of representation allows understanding the meaning of a representation. These representations may undergo two types of transformations: a treatment within the semiotic system -for example a rotation about a C-C axis in a Cram representation leads to another Cram representation- and a conversion from one system to another one. Conversions are transformations of representations that consist in changing the semiotic system without changing the object being depicted-

for example a conversion of a Cram representation to a Newman projection or vice versa.

The way of interpreting or using the semiotic representations of molecules depends on the task to be done. It could be done with a diagrammatic reasoning [9] which means applying a rule or using an analytical reasoning from diagrams without invoking mental images. An iconic visualization [3] can also be used which is the merging of two cognitive operations probably involving mental images. The first operation is a discriminative recognition of shapes and the second operation is the identification of the objects corresponding to the identified shapes.



On figure 1, you can see at first glance that the Newman projection in the centre is eclipsed and the two others are staggered. The two staggered Newman projections are conformational isomers because the atoms attached to the back carbon are not in the same place. But each staggered Newman projection and the eclipsed Newman projection are also conformational isomers because the bonds are not in the same place and the atoms are the same. This example shows that when the two operations are merged, the recognition of spatial structures is easy. The last way of interpreting the semiotic representations of molecules rests on mental visualization also called visual imagery or mental imagery [5, 6, 7] which involves mental rotations and other spatial abilities. Many scholars showed that visuospatial abilities are hard to acquire [1, 2, 6, 8, 10, 11] and that teachers are not always aware of that.

### Goal of the study

In Benin, there is a national syllabus taught in French. The knowledge to be taught in the last year of the upper secondary school (grade 12) includes the spatial structure of molecules (Cram representation), the conformational isomers of cyclohexane and ethane, enantiomers (with one C\*) and optic activity. This is an introductory course in organic chemistry preceding the courses which will deal with the reactivity of organic compounds. The Newman projections are not explicitly mentioned in the syllabus but they are presented in the reference textbook and are widely used by the teachers.

Our research questions from a visualization point of view are the following:

To what extent do grade 12 students in Benin master the semiotic representations of organic molecules?

- Do they master the rules within the Cram semiotic system?
- Are they able to convert a Cram representation into a Newman projection?

We designed a paper and pencil questionnaire made of four questions. It was administered to 340 students aged 17 to 20, after they had been taught the points above.

### Overview of the questionnaire

The first question deals with the permutation of atoms in a chiral molecule. A permutation is clearly a treatment transformation within the Cram semiotic system. The students had to say whether they agree or do not with the statements that were proposed. Does the permutation of two atoms linked to the carbon produce the same molecule or its mirror image? Does a double permutation produce the same molecule or its mirror image? The purpose of this question was to determine whether the students know the double permutation rule which is often used by the teachers to recognize pairs of enantiomers. We expected two types of reasoning, namely applying a rule or using mental visualization.

In the second question the students were asked to draw a Cram representation after rotating a group of atoms about the C-C axis of an eclipsed Cram representation. A rotation of 60 degrees was required and an arrow showed the direction of rotation. The result of this treatment transformation within the Cram se-

miotic system is a staggered conformation and should be obtained with a mental rotation.

In the third question the students had to say which representations out of a list of six Cram representations – three staggered, three eclipsed – were conformational isomers. Two groups of representations were constituted of conformational isomers, the first one included an eclipsed representation and a staggered one, the second one two of each type. We expected two types of reasoning, namely iconic visualization or mental visualization with several steps which are treatment transformations. We also expected that some students would rely on the global shape of the representation to answer and would not pay attention to the position of the different atoms.

In the last question the students were confronted by three Cram representations and three Newman projections. They had to say whether a Newman projection could or could not be obtained by looking mentally on the left or on the right of a Cram representation. For example (figure 2) if one looks at III Cram representation from the left, none of the Newman projection fits, and from the right the correct one is A. This is a complex task typically a conversion between two types of representation requiring mental visualization including spatial orientation and rotation about a vertical axis for instance.

The analysis of the answers was based upon the framework and some categories of answers stemmed from the data after repeated readings.

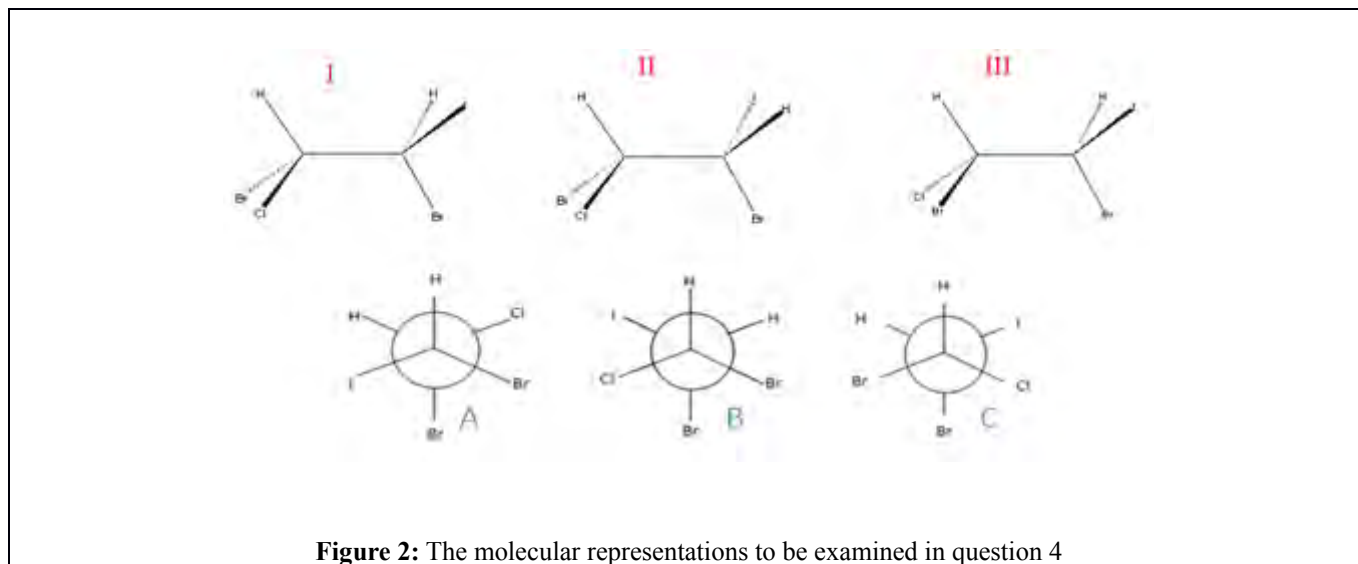


Figure 2: The molecular representations to be examined in question 4

## Results and discussion

In question 1 the students had to say whether they agreed or not with four statements that were proposed. The results are in table 1 below, the correct choices are labelled with a star. A majority of students made a correct choice when one permutation was involved. This was no longer so for two permutations. It is more profitable to examine the consistency of the choices made by the students. 43% of the students surveyed made coherent and correct choices for the first two statements, 27% for the last two statements and only 9% made four correct choices. Most students responded randomly. So we can presume that the rule is not known or memorised and there is no efficient visualization.

Table 1: distribution of answers to question 1 (\* correct choices)

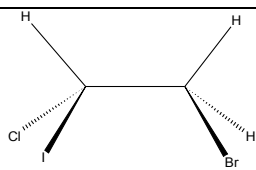
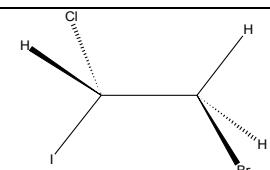
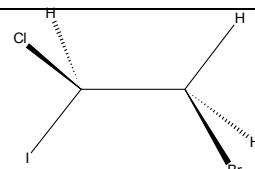
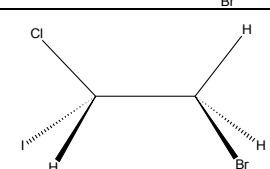
	statements	Agree (N=340)	Do not agree	No answer
S1	One permutation of two atoms gives the mirror image of the molecule	63%*	35%	2%
S2	One permutation of two atoms gives the same molecule	36%	61%*	2%
S3	Two permutations of two atoms give the same molecule	46%*	51%	2%
S4	Two permutations of two atoms give the mirror image of the molecule	53%	44%*	3%



To answer question 2 the students should make a mental rotation of 60 degrees of a group of atoms about the C-C axis. No student drew a correct staggered conformation. One out of ten (10%) provided a staggered conformation but did not consider the positions of the atoms (6%, see table 2) or the alternation of the lines (4%) representing the bonds [8]. Two thirds of the students surveyed (69%) drew an eclipsed conformation and a majority (56%) placed the atoms as if they had permuted them without rotating the bonds (table 2). Other students (21%) made various errors such as no respect of the angles, of the symbolism, of the alternation of the bonds. It is quite clear that there is no efficient mental rotation for a majority of students. Moreover we wonder whether they know the value of the angles and what their ability to imagine a rotation about the axis can be.

In question 3 the students had to find the conformational isomers out of six Cram representations. Half the students surveyed (50%) proposed conformational isomers but 39% considered that conformational isomers are pairs of different kinds, staggered and eclipsed conformations and 2% of a same kind eclipsed - eclipsed or staggered - staggered conformations. Thus we consider that 41% of the students had a limited understanding of the conformational isomerism. 9% of the students proposed any kind of conformational isomers (eclipsed - staggered and eclipsed - eclipsed or staggered - staggered conformations) and thus had a sound understanding. Nearly a third (34%) produced a line of reasoning based on the shape of the conformational isomers without taking the atoms into account. In those cases the iconic visualization is not operative because the discriminative recognition of shapes is favoured and the identification of the object corresponding to the identified shapes is overlooked. 16% did not answer at all.

**Table 2:** some answers to question 2

initial eclipsed conformation		expected staggered conformation	
staggered conformation with incorrect positions for the atoms (6%)		eclipsed conformation (56%)	

In question 4 the students should assign a Newman projection to a Cram representation if possible. This task involving the conversion of a Cram representation to a Newman projection seems to have been the most difficult one. No student gave a totally correct answer. More than a third (36%) did not answer at all. Nearly half the students did not answer each question. 27% of the students made a choice which means that they inverted the symbol of the front carbon and that of the back carbon (the circle and the dot). Nearly a quarter of the students surveyed (24%) seemed to look at a Cram representation from both sides. For example they associated the III Cram representation with the B Newman projection. This choice leads to presume that they firstly looked at the front carbon from the left as expected but then the back carbon seems to have been seen from the right. We assume that most students cannot manipulate proper mental images or even generate them.

### Concluding remarks

A great proportion of students do not master the treatments of the Cram's semiotic representations or the conversion to Newman projections. Indeed the permutation rule is not known, the mental rotation is not efficient and the students find it difficult to visualize the positions of atoms after rotation [10], the iconic visualization is not operative for all of them. Some reasons of a different nature may be proposed: there are not enough visual aids in the learning environment, not enough importance is given to the symbols and the angles of the spatial structures, and teaching conformational isomers mainly or only with ethane

does not help. Further research is needed to find out more reasons. Therefore we are now conducting in-depth interviews to uncover the students' lines of reasoning.

## References

1. R. Barlet, D. Plouin, *Aster*, 1997, 25, 143.
2. N. Barnea, Y. J. Dori, *J. Sci. Educ. Technol.*, 1999, 8, 257.
3. R. Duval, *Annales de Didactique et de Sciences Cognitives*, 2005, 10, 5.
4. R. Duval, *Educational Studies in Mathematics*, 2006, 61, 103.
5. J.K. Gilbert: Visualization: a metacognitive skill in science education. In J.K. Gilbert (ed) *Visualization in science education*, pp. 9-28. Springer, Dordrecht, the Netherlands, (2005).
6. M. Harle, M. Towns, *J. Chem. Educ.*, 2011, 88, 351.
7. P. Marchand, *Annales de Didactique et de Sciences Cognitives*, 2006, 11, 103.
8. V. Pellegrin, A. Sivade, R. Barlet, *Bull. Un. Phys.*, 2003, 97, 909 .
9. M. Stieff, *Sci. Educ.*, 2011, 95, 310.
10. H. Tuckey, M. Selvaratnam, J. Bradley, *J. Chem. Educ.*, 1991, 68, 460.
11. H-K. Wu, P. Shah, *Sci. Educ.*, 2004, 88, 465.

## How does the quality of content-related communication influence the learning outcome in small-groups?

Rebecca KNOBLOCH, Elke SUMFLETH, Maik WALPUSKI

Research Group and Graduate School "Teaching & Learning of Science", Faculty of Chemistry, University of Duisburg-Essen, Schuetzenbahn 70, 45127 Essen; Germany

rebecca.knobloch@uni-due.de

telephone number: +49201/1833761

fax number: +49201/1833149

### Abstract

*The aim of the study is to foster students' content-related communication in chemistry classes using experimental inquiry-tasks. In a first step, the communication characteristics of successful and less successful small-groups were described by a reanalysis of existing video data. Based on this analysis the instructions were revised in order to achieve a higher grade of communication from a subject-specific viewpoint. The learning effectiveness of these revised instructions was examined in an intervention study. This intervention study was used to investigate if a higher rate of high quality content-related statements also leads to a higher learning achievement. Therefore, an experimental pre-test post-test control group design was used. The sample consisted of 192 students of the 7<sup>th</sup> grade which were distributed across 12 secondary schools of a high level. The students worked in groups of 4, over 5 lessons on the topic acids and bases. Cognitive abilities and previous knowledge were assessed and used for balancing control and intervention group. By analysing the 240 videos of the group work and assessing content knowledge it could be shown that the revised instructions lead to a higher rate of high-quality content-related statements. That increase of the content-related quality of students' statements also leads to a higher learning achievement.*

**Keywords:** communication, small-groups, video analysis, experiments

### 1. Background, framework and purpose

#### Initial situation

The (professional) communication has an important role in the acquisition of scientific literacy. Student-student communication can lead to a deeper examination of the content [1]. According to this, communication skills should be encouraged in chemistry lessons, but often communication is dominated by the teacher [2,3]. The percentage of speech of the teachers is about 60-85%. The study presented here focuses on the analysis of the content-related quality of students' statements and their impact on learning achievement.

#### Aims and objectives of the study

The aim of the study is to investigate the relation between the quality of students' content-related statements and the learning outcome. For this purpose, first of all an analysis instrument had been developed to evaluate the content-related quality of students' statements by video analyses. Investigating small-groups is suitable for this analysis, because there is an increased rate of student-student interaction compared to classroom instruction. The target is to answer the following research questions:

1. Which characteristics of content-related statements can be found analysing the statements of successful and less successful small-groups (related to the learning outcome)?
2. Is it possible to increase the quality and amount of statements in content-related communication situations by optimised instructions?
3. Does an improvement of the small group communication lead to a higher learning outcome?
4. Does the altered communication behaviour persist when omitting the instructions to this?

## Assumptions

In general, it can be assumed that the quality of the content-related statements has an influence on the learning outcome. On basis of previous work [4,5] it is assumed that the quality of content-related statements is determined by their correctness, the complexity (fact/s, relation/s, concept) as well as the cognitive processes (reproduction, selection, organisation and integration). Furthermore, it is assumed that students who make content-related statements of a high quality (correct, high complexity and high cognitive process), also perform better in achievement tests.

## 2. Design and method

The study is divided into two parts. In the first step, existing video data from a preceding research project on experimental inquiry tasks in chemistry education [6] were reanalysed. These videos are from cooperative group work in 7<sup>th</sup> grade of secondary schools (high-level) on the topic acids and bases. The reanalysis was used to control if the assumed communication characteristics for successful (more right statements on a high level of complexity and high cognitive processes) and less successful small groups can be described in fact. In this context, success refers to the learning outcome of the small-groups. In addition, the video category system to evaluate the content-related quality of students' statements was developed. For this purpose, 15 videos of successful small-groups and 15 videos of less successful small-groups were analysed turn-based using the programme videograph®. To analyse the video data the number of turns of the videos was related to the number of minutes of the particular video to ensure comparability. The analysis was used to calculate correlations between the measures from video analysis and performance tests and to investigate the reliability of the coding scheme. The assumed quality characteristics complexity, cognitive processes and correctness could be shown as distinguishing characteristics of the groups (see results).

Due to the fact that these correlations do not prove any causal direction an additional intervention study was needed. Therefore, it was investigated whether an optimisation of the quality of content-related statements in small-groups is also associated with an increase of the learning achievement. On basis of the results of the reanalysis the instructions of the small-group work were revised in order to increase the quality of content-related communication. Therefore, intermediary phases were implemented in the small-group work in which students were explicitly asked to talk about the relation of important terms. The learning effectiveness of the revised instructions was examined in an intervention study in the school year 2009/2010. To prove the causality, it was analysed if the learning outcome can be enhanced by the revised instructions, while a control group received unmodified instructions. The sample consisted of 192 students of 7<sup>th</sup> grade of secondary schools (high-level) which were distributed across 12 schools. The students worked in small-groups with 4 students per group about 5 lessons- analogue to the previous study [6]. The intervention group got the revised instructions in lesson 2 to lesson 4. As control variables the cognitive ability test [7] and a test on scientific procedures (NAW) [8] were performed. In addition to this, a test on chemical content knowledge [9] was used (pre-test, post-test and follow-up test). Only in the post-test and the follow-up-test a test on written communication of relations (triad test) was used. Additionally, in each lesson a test on content knowledge, referring to the contents of the corresponding lessons, was conducted. Every group was videotaped during the small-group work so that overall 240 videos could be analysed.

## 3. Results and conclusions

### Reanalysis

To test the developed category system 10 videos were coded independently by two raters. The results of the inter-rater reliability are between  $.83 < \kappa \leq .99$ , so the amount of agreement of the category system is very good. The analysis of the video data of the successful and less successful small-groups could show that successful small-groups are characterised by a higher number of correct content-related statements, statements on a level of relations and the higher cognitive processes: selection, organisation and integration. So, the three assumed quality characteristics could be confirmed.

### Intervention study: video analysis

The intervention group got revised instructions in lesson 2 to lesson 4. The first lesson was used to control if there were any differences between control and intervention group right from the beginning. In lesson 1 there are no significant differences between both groups concerning all categories of the video analysis. Therefore, the differences between the both groups are based on the intervention.

As expected, in lesson 2 to lesson 5 there are no significant differences between the groups on a level of facts, because the intervention focussed on cross-linked knowledge. But the analysis of the statements on a level of relations shows that there are very highly significant differences in favor of the intervention group for each cognitive process in lesson 2 to lesson 4, in which the revised instructions were used (see figure 1). In lesson 5 the revised instructions were omitted. Nevertheless, the altered communication behaviour persists. On a level of relations in all cognitive processes there are significant to very highly significant differences between the both groups (see figure 2). According to this, by the targeted fostering of content-related statements their extent and quality could be increased. Furthermore, it could be shown, that altered communication behaviour persists for at least one lesson when the instructions are omitted.

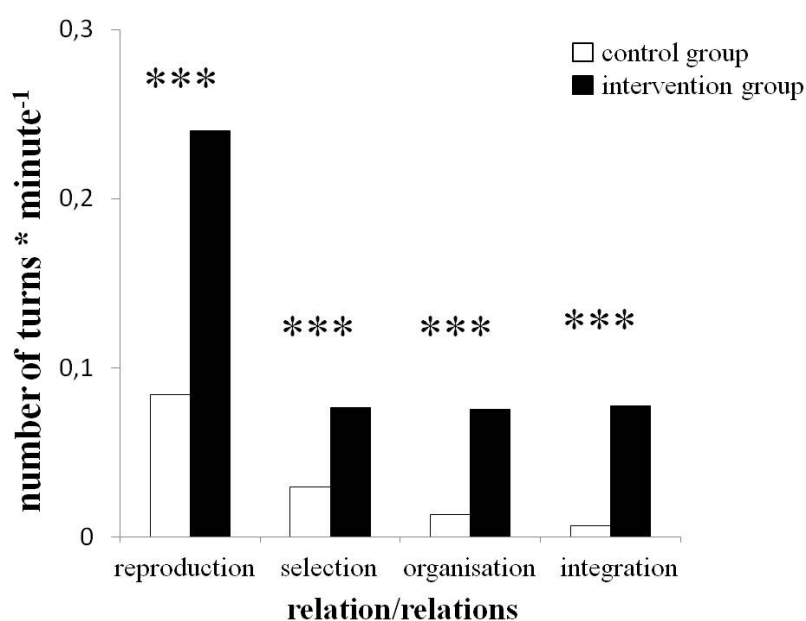


Figure 1

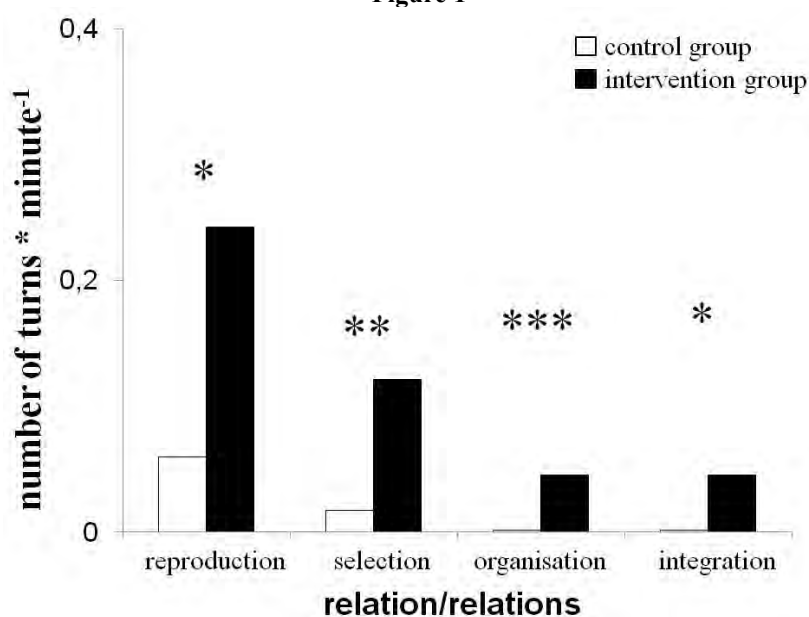


Figure 2

In addition to the video analysis it was investigated if the optimisation of the content-related statements is also accompanied with an increase of the learning achievement. The intervention group shows no significant differences to the control group in the multiple-choice test about factual knowledge. However, the intervention group performs very highly significant better in the triad test (see figure 3), which has an open answer format and assesses cross-linked knowledge. By the optimised communication parts the more complex and cross-linked knowledge of relations could be increased.

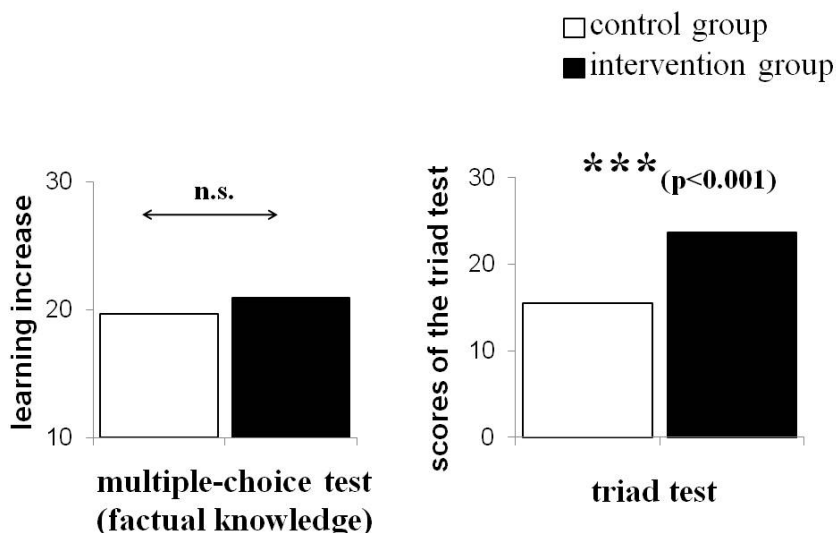


Figure 3 Results of the paper-pencil tests

#### 4. Scientific and scholarly significance of the study

By this study an optimisation of the small-group work could be achieved. Furthermore, the theoretical benefit of the study is a category system to analyse the content-related quality of statements economically. This instrument can be used for further studies. Also, the study could enlighten the influence of the content-related students' statements on learning outcome in small-groups. It was shown that an optimisation of the content-related quality of students' statements also leads to an increase in the learning achievement. It is often criticised, that in chemistry education only isolated factual knowledge is learned and a greater knowledge of networking rarely takes place. In this study, however, the cross-linked knowledge could be fostered in particular.

#### 5. Acknowledgement

We thank the DFG (Deutsche Forschungsgemeinschaft) for funding the project (DFG SU 187/6 – 1; DFG WA2829\_1).

#### 6. References

1. S. Roterding-Steinberg, *Unterrichtswissenschaft*, 1995, 23(4), 332-346
2. E. Sumfleth, A. Pitton, *Zeitschrift für Didaktik der Naturwissenschaften*, 1998, 4(2)
3. A. Schulz, *Experimentierspezifische Qualitätsmerkmale im Chemieunterricht. Eine Videostudie (Experiment-specific quality characteristics in chemistry class. A video study)*, Berlin, Logos, 2011
4. M. Walpuski, N. Kampa, A. Kauertz, N. Wellnitz, *Der mathematische und naturwissenschaftliche Unterricht*, 2008, 61 (6) 323-326
5. A. Lau, K. Neumann, H.E. Fischer, E. Sumfleth, *Video Analyses – Classroom observations and analyses through video recordings – methodological, analytical and conceptual challenges*, Oslo, Norwegen, 2007
6. M. Walpuski, I. Wahser, E. Sumfleth: *Improvement of Inquiry-Learning Using Collaborative Tasks*. In: B. Ralle & I. Eilks (Eds.): *Promoting Successful Science Education – The Worth of Science Education Research* (pp. 197-201). Shaker, Aachen, 2008
7. K. A. Heller, C. Perleth, *Kognitiver Fähigkeitstest für 4. bis 12. Klassen, Revision (KFT 4-12+R) (Cognitive ability test)*. Göttingen, Beltz Test GmbH, 2000
8. S. Klos, C. Henke, C. Kieren, M. Walpuski, E. Sumfleth, *Zeitschrift für Pädagogik*, 2008, 54 (3), 304-322
9. M. Walpuski, *Optimierung von experimenteller Kleingruppenarbeit durch Strukturierungshilfen und Feedback. Eine empirische Studie. (Optimisation of experimental small-group work by structuring aids and feedback)*, Berlin, Logos, 2006

## Use of Worksheets When Teaching/Learning about Mixtures

Ela Ayse KOKSAL<sup>1</sup>, Semra KOCYIGIT<sup>2</sup>, Durdane CAGLAR<sup>2</sup>

<sup>1</sup>Nigde University, Elementary Science Education Department, Nigde, Turkey,  
E-mail: eakoksal@nigde.edu.tr

<sup>2</sup>Inonu Elementary School, Nigde, Turkey,  
E-mail: 593458@meb.k12.tr

### Summary

*The concept of mixture is thought of fundamental of science (chemistry) program and an appropriate understanding of which is very important for further education. Due to some misconceptions, students may not understand the mixtures and related concepts such as atom, element, molecule, and compound. Elementary fourth grade level is important because the mixture and related concepts are first taught in Turkish schools. Well-designed teaching materials such as worksheets can be used to facilitate construction of these concepts in students' minds. In this study, 70 students attending into two classes at the same school were divided into groups consisting of four to six students. Each group were given a worksheet and some materials so that they could form many mixtures and separate them. When the answers of the student groups were analysed, it was found that although the students explained the concept of mixture and separation of mixtures in textbook terms, they gave more free responses to the questions such as how they separated the elements or molecules of a mixture, and whether the way they used in separating a mixture is used in daily life. These factors in the long term might result with students' ability to answer correctly the similar questions on the same concept although nearly a year passed after the study as noted by their own teachers.*

**Key Words:** Mixtures, solutions, concepts, worksheets

### Introduction

Revision of education programs and application of new education methods aim that students learn meaningfully and grow as individuals who express easily what they learned and find solutions to the problems by applying what they learned. Our role as educators in order to ensure meaningful learning is to determine the problems and the source of the problems which inhibit this [1]. Programs such as CHEM Study, CBA, and Nuffield presented many activities to teachers as well as some materials to be used in the lessons. These programs aimed an effective concept teaching [2]. The concepts of element, compound and mixture are essential in chemistry education. An appropriate apprehension of these concepts is crucial for future learning. One important factor which makes understanding difficult is misconceptions. To correct these misconceptions the reasons for their existence and the level of the problem should be uncovered [1]. Worksheets are effective in decreasing students' misconceptions and helping them to understand many concepts [2]. This study was designed to determine whether worksheets can be used to teach/learn mixtures effectively to the fourth grade Turkish students, and to analyse the students' conceptions of the mixture and related concepts.

### Methodology

In order to determine students' understanding of mixtures concepts case study methodology which is suitable to the nature of the problem was used in this study. This method is appropriate to the individual studies, and a special case whose limits are set can be analysed more quickly and easily in depth by focusing on the case itself. Test technique in the form of worksheet has been utilised in this methodology. The worksheet was developed in parallel to the science and technology curriculum. The open-ended questions of the worksheet were concerned with the mixtures, and how their elements or molecules are separated. There were seven questions on the sheet.

The participants of this study are the students in two of the fourth grade classes at Nigde Inonu Elementary School. The approximate age of the group was 10. There were approximately 35 students in each class and a total of 70 students participated to the study.

This study took place in the first semester of 2010-11 education and teaching year. The mixtures concept is given in the second unit, Let's Understand Matter, in the fourth grade science and technology course. Pure substances, mixtures, solutions, and dissolution are taught under the title of 'Matters are found in mixed way in the nature'. Moreover filtering and floatation, separating with magnet, and evaporation are given as methods to separate mixtures. Two lesson hours were allocated to this study. The students in each class were divided into groups consisting of four to six students so that there were 15 groups (eight groups in the first class and seven groups in the second one). Each group were given a worksheet and some matters so that they could form many mixtures and separate them.

Document analysis was used in this study to analyse written documents and students' answers to the worksheet form was examined through descriptive analysis. Document analysis is the review of written resources where the cases, determined in line with the purposes of research, are found. The document analysis method can be supported based on quantitative data. In descriptive analysis the data are summarised according to the predetermined themes. The aim of this analysis is to present the results in organised and explained way. In descriptive analysis: The data are depicted with logical and understandable format; these depictions are interpreted; cause and effect relations are examined and some conclusions are reached; and researcher relates the themes emerged and make these themes meaningful, and make predictions while making interpretations [4].

## Results and Discussion

When the students' answers to "What is mixture?" were analysed, it was found that the groups think of a mixture as a combination of two or more matters ( $f=7$ ); as a structure made of more than one pure substance ( $f=4$ ). Moreover the groups stated that in a mixture the chemical properties of more than one pure substance will not change ( $f=2$ ); and think of mixture as a combination of more than one matter without losing their properties ( $f=1$ ). These answers are close to the explanation that a mixture is a combination of more than one matter without losing their properties. The students also gave examples to some mixtures from their daily life, such as some foods and drinks: Fruit juice, salad, sugared water, and mineral water. These examples are parallel to the examples given by the teachers and the textbooks. Nevertheless the teachers and textbook give uncooked foods and drinks as examples to mixtures, this point was missed by some of the groups ( $f=2$ ) and they gave some food and drink examples that cooked: "Rice + milk = rice pudding", "ashura" (Noah's pudding, traditional food made of beans, rice, wheat, nuts and sugar).

When the students' answers to "Which ways are used to separate mixtures?" were analysed, it was found that the groups cited the following methods mostly; magnetic ( $f=13$ ), floatation ( $f=12$ ), screening ( $f=11$ ), evaporation ( $f=11$ ); filtration ( $f=8$ ), precipitation ( $f=7$ ), and distillation ( $f=5$ ). Exfiltration ( $f=1$ ) and purifying ( $f=1$ ) were the less stated methods by the groups. These answers are close to the mixture separation methods given in the program. On the other hand, the groups stated the concept of filtering with the concept of screening (filtering is for the solid materials with liquids whereas screening is for the big sized solid materials from the small sized materials, or vice versa). Since filtration and floatation was pronounced together under the same heading in the program, it is possible that the students thought them as two separate methods. In the students' answers, it was interesting to see "Distillation" as a method, though it separates solutions. Distillation is an evaporation method in obtaining pure liquid substances. On the other hand, evaporation is obtaining the solid substance from the mixture. Purifying, though indicated by only one group, is to precipitate unwanted part of a mixture by using floatation. Therefore we think the term of purifying relates to floatation and precipitation. It is also possible that when the students think of exfiltration as a method to separate mixtures and they used this term in a broader meaning and it was considered as true.

When the students' answers to "By writing the names of the matters given to you, please state how can



you bring these into a mixture?” were analysed, it was found that almost all groups think that by combining all matters they can make a mixture ( $f=11$ ). The other groups did not directly answer this question, and either gave the names of the matters given to them ( $f=2$ ) or listed the given matters and stated how to separate them ( $f=2$ ). It is concluded that the students know how to make a mixture. The students' answers were also examined with regard to the mixture type and it was found that the groups tried to make either solid-solid mixture ( $f=12$ ) or solid-liquid mixture ( $f=2$ ) from the materials given to them (We think these frequencies are not important, since the type of the mixture asked from the groups to form was related to the materials given to them. The liquid-liquid mixture was not chosen because the program did not include such mixture and the understanding of this mixture type could not be achieved by the students).

When the students' answers to “What can you do in order to separate mixture into matters again? Which ways should you follow for this? What can be the result?” were analysed, it was found that the groups would use filtration and floatation ( $f=3$ ), magnetic ( $f=3$ ), evaporation-straining-screening ( $f=1$ ), floatation, filtration, magnetic ( $f=1$ ), screening, filtration, magnetic ( $f=1$ ), magnetic and screening ( $f=1$ ), screening ( $f=5$ ). The answers show that although the students correctly know about filtration and floatation, magnetic, and evaporation methods in accordance with the program; they also mentioned screening method, which is not stated in the program. It is possible that the screening method in exchange for filtration come to the students' mind when they think of separating the mixtures consisting of solid matters.

When the students' answers to “Using the materials given to you, please separate your mixtures. After than please explain how did you do this and what was the result?” were analysed, it was found that the groups reported filtration and floatation ( $f=6$ ), magnetic ( $f=3$ ), and screening ( $f=1$ ) methods (the remaining groups ( $f=2$ ) did not mention any method). The answers show that students used the materials and formed many mixtures. They then separated these mixtures with appropriate methods. In other words, the students know the rationale behind these procedures.

When the students' answers to “Do you think the method you used to separate mixture is being used in daily life? Who is using it in where, when, how and for what purpose?” were analysed, the groups wrote that magnetic method is being used by certain professionals to separate some substances ( $f=4$ ). When exemplifying magnetic method, the groups mentioned carpenters, who separate sawdust from iron dust ( $f=1$ ), collectors that separate iron, nickel, and cobalt ( $f=1$ ), and both collectors and tailors to separate electronics, certain metals, and needles ( $f=2$ ). The groups also reported that filtration and floatation is being used in the kitchen at home and cafeterias to remove dirt from food ( $f=2$ ). The student groups also mentioned filtration and screening being used in laboratories by professors ( $f=1$ ), screening being used in kitchen to separate bulgur ( $f=1$ ), and flour ( $f=1$ ). The remaining groups did not fully answered this question and gave short and general responses such as ‘Yes it is being used in separating substances’ ( $f=6$ ). The answers show that the students gave as many examples to use of mixture in daily life. The examples were mostly from their home and kitchen and related to food preparation. Filtration, floatation, and screening were common method on these procedures. In addition to this, they gave examples from some occupations such as carpenter, tailor, and garbage collector that primarily use the magnetic method. The students also gave a chemist who is doing filtration and screening.

When the students' answers to “What is solution? Which mixtures you prepared are solutions at the same time? How can we separate solutions?” were analysed, it was found that the groups thought that a solution is a mixture consisted of more than one materials that lost their properties ( $f=1$ ); a solution consists of a soluble and solute, and is a mixture at the same time ( $f=2$ ); when a substance becomes invisible in a liquid ( $f=4$ ), when the sugar dissolved in the water ( $f=1$ ); dissolved state of a substance ( $f=1$ ); separation of mixtures ( $f=1$ ). The remaining groups confused the meaning of solutions ( $f=2$ ), did not fully answered this question and gave the names of the methods ( $f=2$ ), or simply stated that they do not know ( $f=1$ ) or their mixture is not a solution ( $f=1$ ). The groups who confused the meaning of solution stated that a structure formed by separation of two substances ( $f=1$ ) or the melting of a substance with the effect of sun ( $f=1$ ). This means that the students know the meaning of solution, distinguish solutions from

mixtures, and state which one of their mixtures is also a solution. The students also stated that solutions are separated into its matters by evaporation and precipitation (f=1), evaporation (f=3), filtering and evaporation (f=1), screening and evaporation (f=1), filtering, screening, and evaporation (f=1), floatation, using magnets, and screening (f=2), screening, draining, floatation (f=1); evaporation, distillation (f=1); and distillation (f=1). These results show that from these methods, the evaporation was stated more, and the distillation was stated less. Only two group of students thought that solutions are separated with the magnetic and screening methods. Since these methods are used to separate mixtures, we think that the students made mistake when giving example to solution separation and stated magnetic and screening methods besides evaporation. The teachers' explanation of 'All solutions are a mixture' could be the result of this situation. One of the student group thought that solution means melting. This might be a result of an explanation given in the textbook stating that 'when talking about a sugar and water solution, we asks if the sugar either melted or dissolved in the water?' It is possible that these students confused melting with dissolving. On the other hand, the examples to solutions were given mostly from their daily life, mostly drinks, i.e., water and sugar (f=4), water and salt solution (f=1), ayran (traditional drink made of yogurt, water, and salt, f=1).

### Suggestions

When the mixtures subject is being taught, although the program does not state some of the related concepts, such as screening, as a method to separate mixtures, the teachers give these concepts in the class. Additionally, the solution concept is given under the mixtures concept and there is no explanation regarding solution separation methods. These methods are also given by the teachers. We know these concepts from the students' answers. When teaching the methods to use in separating mixtures, the concept of filtering and floatation, precipitation should be also given in the program, because in some mixtures as a result of floatation, some matters float some sink. Since filtration and floatation was pronounced together under the same heading in the program, the students thought them as two separate methods. In order to understand a concept, it should be practiced (or vice versa). In teaching chemical concepts, one of the important goals of chemistry education is to help students to develop a conceptual understanding and to use these concepts in new situations encountered [5]. Therefore the program, teachers, and textbooks provide a learning environment to address development of students' conceptual understanding. It is seen from this study that the worksheets are a better way to conceive students' understanding of subject matter and can be used effectively to promote meaningful understanding.

### References

- [1] N. Sokmen, H. Bayram, *Egitim ve Bilim*, 2002, 27 (124), 56-60.
- [2] B. Costu, F. O. Karatas, A. Ayas, *Pamukkale Üniversitesi Eğitim Fakültesi Dergisi*, 2003, 2 (14), 33-48.
- [4] A. Yildirim, H. Simsek, H. *Sosyal Bilimlerde Nitel Araştırma Yöntemleri*. Seckin Yayıncılık, Ankara 2006.
- [5] M. Calik, A. Ayas, *Pamukkale Üniversitesi Eğitim Fakültesi Dergisi*, 2003, 2 (4), 1-17.

## Minimum Standards in Chemistry Education

Caroline KÖRBS, Rüdiger TIEMANN

*Humboldt-Universität zu Berlin, Department of Chemistry, Chemistry Education*

*Brook-Taylor-Str. 2 - 12489 Berlin*

*www.tiemann-education.de*

*koerbs.caroline@chemie.hu-berlin.de - phone: +49-(0)30-2093-7498 - fax: +49(0)30-2093-7482/6985*

*ruediger.tiemann@chemie.hu-berlin.de - phone: +49(0)30-2093-7510/7575 - fax: +49(0)30-2093-7482/6985*

### Abstract

*The national educational standards in Germany are described as regular standards, the achievements that students they have to reach in general. It is increasingly required to describe student's minimum achievements to enable pupils to participate actively in life and in their professions.*

*A "numeric" definition, after a standard is claimed as a minimum standard, defined by a certain point value, can not be a target-aimed approach from the viewpoint of teaching methodology. There need to be rather preferred and constructed content-related and educational criteria, which determine such a lower boundary of education.*

*This article presents the proposal of a PhD-study. The measuring instrument, a Likert scaling questionnaire will be explained and some results of the pilot study will be given, too. They will provide information of how to describe and formulate minimum standards for chemistry education at the end of compulsory school time, at the age of 15 years.*

**Keywords:** Standards, Chemistry Education, Questionnaire

### 1. Motivation

A comparison of pupils' achievements between the federal states of Germany shows that these vary more highly than in no other PISA-participant country [1]. Therefore requirements for educational justice are getting stronger [2].

German pupils are able to keep up with higher level on education compared to other OECD-countries, but at the lower range of performance they show significant deficits.

This is interpreted as an indication that minimum standards are currently missing in Germany [3]. In other countries, e.g. Sweden or Switzerland minimum standards are implemented in their curricula.

Therefore Klieme et al. [3] call for modeling and a definition of minimum standards, the development of task-pools and test-methods for their survey and the implementation of these kinds of standards in German schools. According to the Association for Didactics [4] minimum standards should be independent of school type and must apply nationally in order to carry on the quality-development of the education system and to reach international comparability [2].

The German ministry of education (Kultusministerkonferenz – KMK) [5] published educational standards for the main subjects German, English and Mathematics for lowest graduation. Such minimum standards are missing so far for other subjects, especially for science.

### 2. Educational Standards

The concept of educational standards was established quite late in the field of education in Germany compared to Anglo-American states. It has been mentioned first in 1860 in field of education in England [3]. Currently having minimum standards is the norm in most education systems around the world [3, 6].

Educational standards formulate achievements for learning and teaching in schools. They characterise aims for pedagogical work, expressed as required educational activities of pupils and students. Therefore standards specify the educational mandate that schools have to fulfill [3].

According to the curriculum of Berlin (Germany) [7] standards clarify, what kind of competencies students have to reach at the end of each grade.

The “Klieme-Expertise” [3] mentions different types of educational standards. Equally McLeod et al. [8], Becker et al. [9] and the Ministry of Education [6] provides a similar classification as Klieme et al. [3]:

A distinction is made between Input-Standards, Opportunity-to-Learn-Standards and Performance-Standards. These are international terminologies.

Input-Standards (Content Standards) describe what kind of competencies have to be developed and what kind of knowledge has to be reached (Content Standards, e.g. curricula). Input-Standards are necessary conditions of learning and teaching.

Opportunity-to-Learn-Standards describe framework conditions of learning, e.g. extent of class hours, equipment of schools etc.

Performance-Standards describe competencies and attainments which are independent of contents. They are the core of the outcome-trend of the educational policy of the twenty-first century.

Within the Performance-Standards there is a determination of minimum, regular and maximum standards [9, 3].

Minimum standards describe the minimum level of a competencies that *all* students of a learning group respective of school or school system have to reach at the end of compulsory school time (at the age of 15 years). In the case of non-attainment arrangements have to be made, e.g. affirmative action for students, improvements in the equipment of schools or sanctions against schools e.g. enhanced supervision up to closing.

According to Ralle [10] minimum standards have to be specified as competencies, which *all* pupils have to command by the end of their time at school in order to actively participate in professional and public life and to be able to arrange their private life, indeed independent of school type, individual general requirements and institutional prospects.

Regular standards are competencies that have to be reached in general, i.e. competencies that have to be reached by the majority of a learning group. Arrangements have to be made in the case of non-attainment on a large scale [9, 3].

Maximum standards or ideal standards define what the best students should know and be able to do [9, 3, 11].

### 3. Area of Research

As mentioned above, performance-standards are divided into maximum, regular and minimum standards. Furthermore in Germany there are four different competencies for science lesson which are implemented in the curricula of physics, biology and chemistry. Science lessons in Germany distinguish between content knowledge, scientific inquiry, communication and decision making. Teachers have to ensure that their students develop these four competencies.

The study of minimum standards focusses on the lowest level of education; the level of minimum achievements. Compulsory school attendance in Germany amounts to nine to ten school years, depending on the federal state. Therefore compulsory school attendance for all children ends at the age of 15 or 16 respective of the state [12].

The federal school system in Germany with 16 different curricula, arising from the 16 different federal states makes it difficult to compare pupils' achievements between the federal states. Standards and minimum standards primarily ensure comparability between different areas within Germany and between different schools.

### 4. Aim and Research Question

The paper should give hints to one of the research hypothesis, which predict the distinction between minimum and regular standards. The central aim of the study is the exemplary description of minimum standards for chemistry at the end of compulsory school time (at the age of 15/16 years). The central research question is: Is it possible to distinguish between minimum and regular standards?

## 5. Design and Method

Within the pilot study 31 teacher trainees were asked for their statements about minimum achievements in chemistry at the age of 15 years. The central question is: What should pupils have to know and what competencies have to be developed in chemistry by the end of their compulsory school time? Do pupils, for example, need to know atoms in detail or is it acceptable if they can just imagine what particles are?

The pilot study shows significant frequency distributions and that a preliminary catalog of minimum standards could be constructed. A *Likert* scaling questionnaire has been constructed for the pilot and the main study to ask groups of stakeholders for their opinions about minimum achievements [13].

Table 1 shows an excerpt of the questionnaire. Two items are shown; the first is by the 31 students claimed as a minimum standard, the second I claimed as a regular standard or as a standard of a higher level of education. If experts mark (1) or (2) they believe that the mentioned standard is a minimum standard, if they mark (3) or (4), they indicate that it is a regular standard. In figure 1 the boundary between minimum and regular standard becomes visible. The frequency distribution of the pilot study shows that the first item is claimed as a minimum, the second as a regular standard:

**Table 1:** Excerpt of the questionnaire, frequency distribution, n = 31 trainee teachers [14]

The students...	strongly agree (1)	agree (2)	disagree (3)	strongly disagree (4)
1) prepare the constitution of atoms with the nucleus-shell-model.	<b>10</b>	<b>13</b>	<b>07</b>	<b>01</b>
2) prepare the constitution of atoms with the nucleus-shell-model with a differentiated shell.	<b>04</b>	<b>07</b>	<b>17</b>	<b>03</b>

The main-study considers three groups of interest respectively three groups of “experts”: chemistry teachers at school, chemistry teachers at university and chemists working in the industry and economy, with a sample of 30 study participants of each group.

Based on the results of the pilot study the structure of the questionnaire has been improved and optimized. 107 items could be selected out of 198 items by a t-test for one sample. Table 1 shows scale from one up to four, in order to avoid a tendency to the middle in case of a five point scale. Furthermore it is a theory-driven questionnaire based on the educational standards of the Ministry of Education [14], on the concepts of chemistry [14] and also based on the characteristics of minimum standards [4].

## 6. Results of the Pilot Study

The results of the pilot study provide information about classifications of minimum and regular standards in chemistry education at the end of compulsory school time and furthermore a preliminary catalog for the basic minimum requirements in chemistry could be developed. For example the first item in table 1 is claimed as a minimum standard.

Contexts for minimum standards have been given a reference to: everyday life, healthy living, safety aspects in experiments, pollution control, use of resources, ecology and ethics.

## 7. Outlook

Next step of the project is the analysis of the data of the main study. It is planned to compare the data of the three different expert groups – chemistry teachers at school, chemistry teachers at university and chemists working in the industry and economy.

Table 2: Timetable

pilot study: 04/11– 11/11	main study: 11/11 – 07/12
n = 31 (students of chemistry education, within Berlin)	n = 3×30 (three groups of experts, within Germany)

## References

- [1] PISA (Eds.), Educational level of young people in Germany [PISA-Konsortium Deutschland (Hrsg.), Der Bildungsstand der Jugendlichen in Deutschland] Münster, Waxmann, 2004.
- [2] Union of Education and Science, National educational standards – panacea or appalling stuff? [GEW, Nationale Bildungsstandards – Wundermittel oder Teufelszeug? Funktionen, Hintergründe und Positionen der GEW, Gewerkschaft Erziehung und Wissenschaft (Allgemeiner Deutscher Lehrer- und Lehrerinnen-Verband) Frankfurt/ Main, pp.12f., 2003.
- [3] Klieme, E.; Avenarius, H.; Blum, W.; Döbrich, P.; Gruber, H.; Prenzel, M.; Reiss, K.; Riquarts, K.; Rost, J.; Tenorth, H.-E. & Vollmer, H. J., Development of national educational standards: an expertise, Ministry of Education and Research (BMBF) (Eds.) [Zur Entwicklung nationaler Bildungsstandards: eine Expertise, Bundesministerium für Bildung und Forschung (Hrsg.) Bonn, Berlin, pp.10ff., 2009.
- [4] Association for Didactics, Minimum standards at the end of compulsory school time, [GFD, Mindeststandards am Ende der Pflichtschulzeit. In: Zeitschrift für Didaktik der Naturwissenschaften] Journal of Science Education, year 15, p.1, 2009.
- [5] KMK – Conference of Ministry of Education (Eds.), Educational standards for German, Mathematics and English at the age of 15 [KMK – Kultusministerkonferenz (Hrsg.), Bildungsstandards für den Hauptschulabschluss für die Fächer Deutsch, Mathematik, erste Fremdsprache] Berlin, 2004a.  
[http://www.kmk.org/fileadmin/veroeffentlichungen\\_beschluesse/2004/2004\\_10\\_15-Bildungsstandards-Haupt.pdf](http://www.kmk.org/fileadmin/veroeffentlichungen_beschluesse/2004/2004_10_15-Bildungsstandards-Haupt.pdf) (20.08.2012)
- [6] KMK – Conference of Ministry of Education (Eds.), Educational standards of KMK, explanation for conception and development [Bildungsstandards der Kultusministerkonferenz, Erläuterungen zur Konzeption und Entwicklung] Berlin, 2004b.  
[http://www.kmk.org/fileadmin/veroeffentlichungen\\_beschluesse/2004/2004\\_12\\_16-Bildungsstandards-Konzeption-Entwicklung.pdf](http://www.kmk.org/fileadmin/veroeffentlichungen_beschluesse/2004/2004_12_16-Bildungsstandards-Konzeption-Entwicklung.pdf) (20.08.2012)
- [7] Senate of Berlin (Eds.), Curriculum of chemistry at the age 13-16 [SenBJS (Hrsg.), Rahmenlehrplan für die Sekundarstufe I, Chemie] Berlin, 2006.  
[http://www.berlin.de/imperia/md/content/sen-bildung/schulorganisation/lehrplaene/sek1\\_chemie.pdf?start&ts=1245159489&file=sek1\\_chemie.pdf](http://www.berlin.de/imperia/md/content/sen-bildung/schulorganisation/lehrplaene/sek1_chemie.pdf?start&ts=1245159489&file=sek1_chemie.pdf) (20.08.2012)
- [8] McLeod, D. B.; Stake, R. E.; Schappelle, B.; Mellissinos, M. & Gierl, M. J., Setting the Standards: NCTM's role in the reform of mathematics education, S. A. Raizen & E. D. Britton (Eds.), Bold ventures: U.S. innovations in science and mathematics education. Vol 3: Cases in mathematics education, pp.13-132, Dordrecht, The Netherlands: Kluwer, 1996.
- [9] Becker, G.; Bremerich-Vos, A.; Demmer, M.; Maag Merki, K.; Priebe, B.; Schwippert, K.; Stäudel, L. & Tillmann, K.J. (Eds.), Standards: teaching between competencies, central exams and tests [Standards: Unterrichten zwischen Kompetenzen, zentralen Prüfungen und Vergleichsarbeiten] Seelze, Erhard Friedrich GmbH, 2005.
- [10] Ralle, B., Do we need minimum standards? [Brauchen wir Mindeststandards?] MNU, year 62, booklet 5/2009, p. 259, 2009.
- [11] Reiss, K., Minimum standards as challenge for math class. In: Heinze, A.; Grüßing, M. (Eds.): Learning mathematics from kindergarten up to college [Mindeststandards als Herausforderung für den Mathematikunterricht. In: Heinze, A.; Grüßing, M. (Hrsg.): Mathematiklernen vom Kindergarten bis zum Studium] Münster, Waxmann, p.191-189, 2009.
- [12] Avenarius, H.; Heckel, H.; Loebel, H.-C., school laws: manual for practice, law and science [Schulrechtskunde: Ein Handbuch für die Praxis, Rechtsprechung und Wissenschaft] edition 7, Luchterhand, Neuwied, 2006.
- [13] Bortz, J. & Döring, N., Research methods and evaluation for human and social scientists [Forschungsmethoden und Evaluation für Human- und Sozialwissenschaftler] Springer, Heidelberg, p.177, 2006.
- [14] KMK – Conference of Ministry of Education (Eds.), Educational standards in chemistry education at the age of 16 [Bildungsstandards im Fach Chemie für den Mittleren Schulabschluss] Berlin, 2004c.  
[http://www.kmk.org/fileadmin/veroeffentlichungen\\_beschluesse/2004/2004\\_12\\_16-Bildungsstandards-Chemie.pdf](http://www.kmk.org/fileadmin/veroeffentlichungen_beschluesse/2004/2004_12_16-Bildungsstandards-Chemie.pdf) (20.08.2012)
- [15] KMK – Conference of Ministry of Education (Eds.), Strategy of support for underachieving students [Förderstrategie für leistungsschwächere Schülerinnen und Schüler] Berlin, p. 10, 2010.  
[http://www.kmk.org/fileadmin/veroeffentlichungen\\_beschluesse/2010/2010\\_03\\_04-Foerderstrategie-Leistungsschwaechere.pdf](http://www.kmk.org/fileadmin/veroeffentlichungen_beschluesse/2010/2010_03_04-Foerderstrategie-Leistungsschwaechere.pdf) (20.08.2012)

## The Effect of Teaching of the subject “Precipitation Titration” using Animations on Student Achievement

Nazan KUNDUZ, Nilgün SECKEN

Hacettepe University Education Faculty Ankara, TURKEY

E-mail: nazankunduz@gmail.com

### Abstract

*The aim of this study is to identify the effects of a software developed based on the 7E learning model towards the teaching of “precipitation titrations” on the student achievement. The participants of the study includes 13 undergraduate students taking the course, Analytical Chemistry II and 89 vocational high school students. The study has two different designs for two categories of the participants. Specifically, in regard to undergraduate students, the design was pre- and post-test with a single group. For the vocational high school subjects, the design used was pre- and post-test with a static group. The data of the study were collected through “achievement test on precipitation titrations”. The Cronbach alpha coefficient of the achievement test was found to be 0.756. The findings obtained were analysed through t-tests. The findings indicate that there are statistically significant differences between pre-test scores and post-test scores of both experiment groups and control group. Furthermore, the pre- and post-test scores of the two groups on the achievement test for the high school sample were also statistically significant different. This difference indicates that the software has positive effects on student achievement.*

**Key Words:** Chemistry education, constructivism, 7E learning model, animation, precipitation titrations

### 1. Introduction

Dominant learning environment in Turkey is described as a closed classroom setting in which lectures are mostly used and which is composed of teacher, students, textbooks and boards (Başaran, 1993). On the other hand, it is well-established that since physics, chemistry and biology contains many abstract concepts, students tend to develop misconceptions and that they have difficulty in relating their learning with daily life activities (Ayas and Özmen, 1998; Kadioğlu, 1996; Özmen, İbrahimoglu and Ayas, 2000). Research suggest that traditional teaching methods are not effective in overcoming these problems and that those teaching methods enabling the students to actively participate in the learning process should be used (Hewson *et al.*, 1984; BouJaoude, 1991; Stavy, 1991; Guzzetti, 2000; Özmen and Kolomuç, 2004). One of such methods is constructivist approach that allows for active student participation (Fensham, 1992; Matthews, 2002). Constructivist approach to learning is mostly complemented with multi-media assisted learning activities. Research indicates that such activities have positive effects on the student achievement (Harwood and McMahon, 1997). Chemistry education is one of the disciplines included in university education system. Chemistry is one of the difficult subjects for many students (Yang *et al.*, 2003; Gilbert *et al.*, 2004 in Pekdağ, 2010). The reasons for this difficulty seem to be related to the abstract nature of chemistry. It is also reported that teachers have serious difficulty in teaching chemistry and that students mostly develop misconcepts in regard to chemical topics and concepts (Taber, 1997; Boo, 1998; Tan and Treagust, 1999; Nicoll 2001; Piquette and Heikkinen, 2005; Doymuş and Şimşek, 2007; in Karaçöp, *et. al.*, 2009). Students should understand, remember and visually animate the dynamic chemistry processes in order to learn them. At this point, computers should be emphasized since they enable the students to achieve visually animation of these processes (Williamson and Abraham 1995; Sanger and Greenbowe, 1997. In recent years, computers have been employed to overcome the difficulty experienced by students in learning basics of chemistry. Therefore, animations, simulations, videos and other similar tools have become significant for chemistry instruction (Pekdağ, 2010). In the study the effects of an instructional software on students’ chemistry achievement were examined. Specific chemys-

try topic analysed is precipitation titrations. The reason for choosing this subject is that it has not been studied and that it is the last unit in chemistry textbooks. The aim of this study is to identify the effects of a software developed based on the 7E learning model towards the teaching of “precipitation titrations” on the student achievement. The study tries to answer the following research questions:

In regard to the undergraduate student sample

1. Is there any statistically significant difference between pre- and post-test achievement scores of the undergraduate students who are taught the unit of “precipitation titrations” through animations and instructional computer games?

In regard to the vocational high school student sample

2. Is there any statistically significant difference between pre-test achievement scores of the experiment high school students who are taught the unit of “precipitation titrations” through animations and instructional computer games and of the control high school students who are taught the unit of “precipitation titrations” through traditional teaching methods?
3. Is there any statistically significant difference between pre- and post-test achievement scores of the control high school students who are taught the unit of “precipitation titrations” through traditional teaching methods?
4. Is there any statistically significant difference between pre- and post-test achievement scores of the experiment high school students who are taught the unit of “precipitation titrations” through animations and instructional computer games?
5. Is there any statistically significant difference between pre- and post-test achievement scores of the experiment high school students who are taught the unit of “precipitation titrations” through animations and instructional computer games and of the control high school students who are taught the unit of “precipitation titrations” through traditional teaching methods?

## 2. Method

In regard to undergraduate students, the design of the study was pre- and post-test with a single group. For the vocational high school subjects, the design used was pre- and post-test with a static group. The participants of the study includes 13 undergraduate students taking the course, Analytical Chemistry II. These students attend the Chemistry Education branch at Hacettepe University. There are also 89 vocational high school students attending to Ankara M. Rüştü Uzel technical and Industri Vocational High School. All high school students are eleven-graders. 45 of the high school subjects formed the control group of the study.

### Data collection tools

#### Achievement test on precipitation titrations (ATPT):

As it is known, achievement tests measure the student progress in terms of knowledge, conceptual learning and understanding at the end of the instruction (Yıldırım, 1999). Achievement test on precipitation titrations was developed by the authors. ATPT includes 19 multiple choice items. Before developing the test, the related studies were reviewed. Then, the views of field specialists and chemistry teachers were sought. The reliability and validity of the test was analysed with a sample of 104 students who took the related course. Based on the results of the pilot study, the test was finalized. The analyses showed that the alpha reliability coefficient of ATPT is 0.756. Its mean difficulty is found to be 0.507. Its mean discriminatory power is found to be 0.426. Therefore, ATPT is a reliable and valid test.

#### Data collection and Data analysis

The teaching of the unit, precipitation titrations, lasted at equal period for each study group. As stated earlier, the unit “precipitation titrations” was delivered through traditional teaching methods in the control group. It was taught in the experiment groups via the educational software. The data obtained were analysed through the SPSS version 15.0 using t-tests. Two types of t-tests were employed in the analyses: “*Paired Sample t-tests*” to determine significant difference between pre- and post-test scores of the



groups (intragroup differences), “*Independent Sample t-tests*” to determine the differences among the groups before and after the implementation. Statistically significance level was set to be  $p < .05$ .

### 3. Findings

#### Discussion of the findings regarding the first research question

The pre- and post-achievement test scores of the undergraduate students are analysed in terms of difference using Paired Sample t-test. The results of the analysis are given in Table 1.

**Table 1.** Comparison of pre- and post-achievement test scores of the undergraduate students

	N	$\bar{x}$	SS	sd	t	p
Pre-test	13	7.15	2.115	12	-53.156	.000
Post-test	13	17.31	1.797			

#### Discussion of the findings regarding the second research question

The pre-test scores of the experiment and control groups were compared through independent t-test and the results of the analysis are given in Table 2.

**Table 2.** Comparison of the pre-test scores of the experiment and control groups

Groups	N	$\bar{x}$	SS	sd	t	p
Experiment group	44	4.93	2.389	87	.580	.564
Control Group	45	5.20	1.946			

#### Discussion of the findings regarding the third research question

The pre- and post-test scores of the control group were compared through Paired Sample t-test and the results of the analysis are given in Table 3.

**Table 3.** Comparison of the pre- and post-test scores of the control group

	N	$\bar{x}$	SS	sd	t	p
Pre-test	45	5.20	2.389	44	-23.129	.000
Post-test	45	9.16	1.623			

#### Discussion of the findings regarding the fourth research question

The pre- and post-test scores of the experiment group were compared through Paired Sample t-test and the results of the analysis are given in Table 4.

**Table 4.** Comparison of the pre- and post-test scores of the control group

	N	$\bar{x}$	SS	sd	t	p
Pre-test	44	4.93	1.946	43	-14.020	.000
Post-test	44	11.20	4.663			

#### Discussion of the findings regarding the fifth research question

The post-test scores of the experiment and control groups were compared through independent t-test and the results of the analysis are given in Table 5.

**Table 5.** Comparison of the post-test scores of the experiment and control groups

Study groups	N	$\bar{x}$	SS	sd	t	p
Experiment group	44	11.20	4.663	87	-2.756	.008
Control group	45	9.16	1.623			

#### 4. Results and Discussion

The aim of this study is to identify the effects of a software developed based on the 7E learning model towards the teaching of “precipitation titrations” on the student achievement. Achievement test on precipitation titrations were administered to all participants as a pre-test. There is no statistically significant difference between groups’ pre-test mean scores ( $p > .05$ ). Therefore, both groups have similar prior knowledge before the implementation. mean pre- and post-test scores of the undergraduate participants are 7.15 and 17.31, respectively. The results of dependent t-test shows a positive value in favor of post-test. This finding shows that the software used in the study has positive effects on the achievement level of the sample. The pre- and post-test scores of the control group are 5.20 ve 9.16, respectively. There is an increase of 3.96 in their arithmetical means. The pre- and post-test scores of the experiment group are 4.93 and 11.20, respectively. There is an increase of 6.27 in their arithmetical means. This finding suggest that teaching with software increased the achievement levels of the experiment students much more than traditional teaching method. This finding is consistent with the finding of Harwood and McMahon (1997), stating that the use of multi-media-assisted learning activities contribute to the student achievement in learning the hard concepts since such activities simulate the students’ visual and cognitive structures. It is also in the same line with the findings of the following studies: Ebenezer (2001), Short (2002), Tezcan and Yılmaz (2003), Akçay et. al. (2003), Özmen and Kolomuç (2004), Allred (2004), Saka and Yılmaz (2005), Karamustafaoğlu et. al. (2005), Kızılcı and Yumuşak (2005), Obut (2005), Daşdemir (2006), Gürses et. al. (2006), İlbi (2006), İskender (2007), Akçay et. al. (2007), Marbach-Ad et al. (2008), Bozkurt and Sarıkoç (2008), Papestrengiou (2009), Bülbül (2010), Kahraman and Demir (2010) and Uzunkoca (2012). On the other hand, Yiğit (2007) and Daldal (2010) did not find any difference between the students’ achievement levels when one group was taught through traditional methods and the other through computer-assisted teaching activities.

Based on the findings of the study the following suggestions are developed concerning both future studies and teaching practices: Learning materials should be developed in order to implement computer-assisted chemistry instruction. Such materials should be developed following the related principles and techniques of learning material development. Plain, user-friendly interfaces should be designed and colors and other elements should be age-appropriate. Universities and schools should have Research and Development sections to develop learning materials. Softwares should be age-appropriate and compatible with the curricula. These softwares should be developed by experienced educators. Softwares developed should be tested in schools under the pilot studies. Based on the findings, necessary revisions should be made on the softwares. National education provincial directorates should provide the opportunity to make projects on the development of computer-assisted learning materials. There should be more studies on the use of educational computer games in Turkey. Teachers should be offered in-service training activities regarding computer technology and they should follow related advances.

#### References

- Ayas, A. and Özmen, H. Asit-Baz Kavramlarının Güncel Olaylarla Bütünleştirilme Seviyesi: Bir Örnek Olay Çalışması. III. Ulusal Fen Bilimleri Eğitimi Sempozyumu, KTÜ, Trabzon (In Turkish).1998.
- Başaran, İ. E. Türkiye Eğitim Sistemi. Ankara. Kadioğlu Matbaası 1998.
- BouJaoude, S. B., (1991). A Study of the Nature of Students' Understanding about the Concept of Burning, *Journal of Research in Science Teaching*, 28(8): 689-704.
- Guzzetti, B. J., (2000). Learning Counter Intuitive Science Concepts: What Have We Learned From Over a Decade of Research?, *Reading, Writing, Quarterly*, 16(2): 89-95.
- Hewson, P. W. and Hewson, M. G., (1984). The Role Conceptual Conflict in Conceptual Change and The Design of Science Instruction, *Instructional Science*, 13, 1-13.
- Kadioğlu, A. K. (1996). Fen Bilimleri-I ve II’de Yer Alan Bazı Kimyasal Kavramların Öğrenciler Tarafından Anlaşılma Seviyesi. KTÜ Fen Bilimleri Enstitüsü, Yüksek Lisans Tezi, Trabzon (In Turkish).
- Ozmen, H., İbrahimoğlu, K. and Ayas, A. (2000). Lise II Öğrencilerinin Kimya-I Konularında Zor Olarak Nitelendirdikleri Kavramlar ve Bunların Anlaşılma Seviyeleri. IV. Ulusal Fen Bilimleri Eğitimi Sempozyumu, Hacettepe Üniversitesi Eğitim Fakültesi, Ankara (In Turkish).
- Özmen, H. ve Kolomuç, A., (2004). Bilgisayarlı Öğretimin Çözeltiler Konusunda Öğrencilere Etkisi, *Gazi Üniversitesi Kastamonu Eğitim Fakültesi Dergisi* 12: 57-68.

## Information Technologies in Service of Chemistry Teaching (On an Example of concrete Program)

**Ketevan KUPATADZE**

*Professor of faculty art and science of Ilia state University Tbilisi, Georgia  
Kakutsa Cholokashvili Ave 3/5 - Tbilisi 0162, GEORGIA  
Ketevan\_kupatadze@iliauni.edu.ge(+995 599290905)*

### Abstract

*The article presents author's multi-media teaching course on school course chemistry, created in Ilia State University. Teaching materials are presented together with visual dynamic models of chemical processes. The changes and additional information can be introduced any time due to the structure of the course. Therefore, the model contains the elements of Case Study.*

*Those principles of didactics are considered, realization of which are particularly efficient by educational computer programs on the lessons of chemistry. The question is about the stages of educational process, during which teacher can efficiently use such programs. In the article is overviewed the situation of teaching chemistry in Georgia nowadays- problems and the ways of solution of this problems. Is shown the ways to integration chemistry with other subjects, e.g. biology, history and arts.*

**Author Keywords:** authoring tools and methods; human-computer interface; multimedia systems; virtual reality.

Chinese sage was asked: what can we do in order that people live better. He answered, that it depends on period of time. If it is only one year, sow rice for the subsistence of people. If it is twenty years, than plant fruit trees, than people can delight with fruits. If you mean hundred years, educate the people and every problem will be solved.

It is indisputable truth. There is nobody stronger than educated man. Although, unfortunately some subject have the "privilege" to be "fearful" for children. At the lessons of the "fearful" subjects children come with sense of duty and they bring nothing from lessons. What is cause? They have not motivation. In this case I mean the chemistry. Where are the roots of such attitude to chemistry? They must be searched in the process of teaching of chemistry, in the forms of its account and present to the children. This form must have one aim – to go to the lesson of chemistry must be a little holiday and not obligation, because a pupil does not afraid this subject. To excite the curiosity of a pupil is very easy, especially to such "indocile", "capricious", "stimulant" science as chemistry. The points on the agenda are in what form present and discuss each chemical phenomenon.

So, how can we interest pupils on the lessons of chemistry? Which principle of didactics is better to create merry and gripping lesson? –We accentuate on obviousness, on scientific character and availability (certainly it is our opinion and it is possible that others accentuate on different approach.

I want briefly review each principles [1-2].

The *obviousness* principle is very important for the lessons in chemistry and other natural sciences. It is very difficult to imagine chemistry without experiment, which unfortunately is very rarely carried out nowadays in Georgian schools; on account of the lack of laboratories, preparations or simply time (not enough hours and enormous material). Such experiments also exist, which need special rules of safety and teachers in justice try to avoid them. Different chemical mechanisms, which are very difficult to study for pupils, need special obviousness and not only simple static picture, which they can see in books or in educational posters.

*Availability* principle and *scientific* character are also very important. Teacher must try to interest , motivate pupils with the subject (in our case - chemistry). Teacher must be in permanent search to find in-

interesting chemical histories and join it with them. By means of interesting chemical events and curiosities he can scientifically discuss the theme. For example, pupils may not know that the “reason” of “Titanic” ’s going down was hydrogen bonds, because it had run into iceberg. The firmness of iceberg (ice) is caused by hydrogen bonds. The density of iceberg (ice) is less than of water and it can float on the surface of water. It will be interesting to discuss the nature of bonds, which had ruined legendary “Titanic”.

Or... Everybody had felt that after thunder-storm air is very fresh. Why? Yes, ozone forms in atmosphere, which is unstable and decomposes with the isolation of oxygen. What are ozone and oxygen to one another? And what is oxygen, oxygen- which we breathe?

End now we want to discuss the problem of the form of presentation of different questions, about what we had spoken above. One of the most effective form (among other forms) of the presentation of material to pupils is the educational computer program, which gives possibility to realize above-mentioned all three principles.

The *obviousness* principle in such programs can be realized very efficiently, because it can not be only static and planar, but dynamic and practical, decorated with different effects, among them-sound effect. It can be hyper textual with complex labyrinths, from where we can pass to another logically connected obviousness.

The modeling of the experiments in such programs can be represented by different spectrum, (among them for the experiments which need special rules of safety), if we carry them in real time in the process of lesson.

There are a lot of possibilities in this programs to realize the rest two principles.

Such computer-educational programs are also called “Author’s programs”, because they represent the view of given author or the group of authors, which are unique and never be repeated. In spite of this, it is inadmissible that such program was turned into the electron version of any textbook.

When creating educational courses, we must take into consideration, that they must not be transformed into electric version of textbooks (without any novelty). Such courses (they can be called “Author’s courses”) must reflect the view of the teacher (or the group of teachers) which created them, about the optimum teaching of the correspondent subject. The author’s courses are created on the basis of the knowledge, methodical and didactic finds of the teacher (or the group of teachers).

The main aim of creating electric programs is to establish the model of the process of teaching concrete course. In this case it is important not only the specific character of the subject, but the individual habitus of the creator of the course, it is also important the establishment of the general methodic with general methods and general instruments. Such methodic contain the description of the content of the course on the basis of semantic nets, which are connected in definite limits by variable succession from the simple to the complex. They can be founded fractal-layer by layer. This layers create the skeleton and on its basis the whole process is formed. The visualization will be static, dynamic and spatial. The teacher, on each stage of the teaching, can apply to the resources of the illustration which he needs.

The content of educational material must coincide to the national educational plan, but it must be enriched by more information, by concrete examples and with corresponding commentary [3-4]. Some of the topics will be teaching by axiomatic method and information will be represented in the form of graph- the unity of concrete and declaration teaching will be realized. Each topic will be connected with the knowledge of a pupil. The content will be in accordance with modern state of the sciences.

Program created in Adobe “Flash” casing and it gives additional advantages, in particular it can be used in network teaching.

In Georgia, to overcome the “fear” to natural subjects (in this case-chemistry), to interest pupils and to create motivation is very actual. This problem exists, and it is proved by the fact that in 2008, on national examinations, there were only few pupils, which wanted to go in for an examinations in natural sciences. The Country can’t develop without chemists, biologists and physicists.

For example, the opinion of some teachers and pupils are adduced about computer-educational program in chemistry for basic schools (the originals of forms are kept in working-room of our group).

**Teachers:**

*“I want to ask you to create such programs for high classes”. The chemistry teacher of 16<sup>th</sup> public school Kh. Nozadze.*

*“You must continue your work!!! To show animated experiments is very useful, especially in such schools, where they have not laboratories, but have computer.” The chemistry teacher of 165<sup>th</sup> public school N. Nadiradze.*

*“I had adopted your uncommon idea with great pleasure. I am delighted, I like it very much! I hope you will contact with me after innovations.” The chemistry teacher of 2<sup>th</sup> public school Kh. Bregadze.*

*“I greet this innovation, I shall always have desire to use it.” The chemistry teacher of 100<sup>th</sup> public school Msveneradze.*

**7<sup>th</sup> class**

*“When studding the classes of chemical compounds we use computer program. It is very interesting. Afterwards we ask teacher and he carried out the experiment between sulfuric acid and sugar. It was identical to what we had seen in program. It is nice, if it will continues in such a way, we shall become chemists. Such lesson is very interesting and we want more lessons.”*

*“The teacher had taken us to the informatics room. She had explained the properties of water and we had watched chemistry program. I like “You are vineyard”, bubbles of soap. At home I had done it myself.”*

*“Show it again. We had understood it. I had remembered how to construct and represent chemical formula. The Georgian dance between Fe and S is bright. I am interested what I had seen in computer.”*

*“I had understood well and remembered mixers, the methods of their division on components. We often can't carry out the experiments, therefore I want to study chemistry by this program.”*

**8<sup>th</sup> class:**

*“I think such lessons must be held in every classes. It is one of the way to give knowledge to the child, which is not interested in chemistry. Even though the minimum from the whole information”.*

*“In my opinion, the CD with such themes must be in every schools, to excite the curiosity of more pupils.”*

*“I have learned very much about chemical elements, the Periodic Table, famous chemists. Especially interesting were video materials and clips. You see everything obviously and get pleasure. I like that the mater is written clearly and it is easy to understand. I think that the CD is perfect for all ages and professions.”*

*“More material must be created in future, to interest pupils and pleasure them by studding chemistry.”*

I want to underline one circumstance. Different education foreign (free) computer programs in chemistry exist (many of them we had seen by internet or on CD), also internet-sources (for example, Wikipedia - the free encyclopedia), but in this sources above-mentioned didactic principles are realized very poorly. I can't find the full dynamic obviousness in them. In some of them it was represented, but very poorly. The aim of such program is less text and a lot of dynamic obviousness and different methodic- ways for the pupil's motivation. It is known fact that for teaching two main factors are obligatory: teaching pupils with refined methodic and motivation for the study of presented information.

I mean to introduce such heading as: “May you will be interested”, “May be you try”, “Now let us amuse our self”. I mean to find a lot of chemical curious (to create animation about this curios). To make musical background to the created chemical clips. Musical backgrounds can different from each other. For example, in already created program we have “Chemical theatre” were elements go out on Shtraus’ march, make the acquaintance with pupils and present very interesting information about themselves. In other clips there is folklore and even though rock, why not! On the whole we shall get motivated pupil and it is our aim.

It is known in psychology that a person absorbs 90% of information of the surrounding environment, from vision 9% from hearing and 1% from touching [2].

Also “teenager” gains latently more material, he/she uses in a specific reason, though there may not be the question of remembering of material” .

To remember something latently is depended upon the emotional mood to the material which should be remembered.

Is a student indifferent towards the subject he /she remembers it superficially.

Everything which causes emotional feeling leaves the deep track in the mind and is fixed firmly.

In this case it is very important to make students interested in studying material. Such interest may be risen by using computer learning programs and the lectures given according to it rise students ‘remembering mechanism of reachiness and mood towards the learning material.

According to D. Uznadze conception mood is created in simultaneous figurative conditions of two factors, with the demand of a person in the suitable environment of the given figurative conditions. If one of these factors isn’t given the mood won’t be created. A person will get into mood with the fulfillment of the activity of the specific situation based only on to the suitable requests (D. Uznadze. “The Psychology of Mood”) [1].

Computer gives the opportunity to get vivid, eminent and convincing illustrations about those events, which are attached to this or that chemical process.

The process is reflected in dynamics on the screen of the computer together with the selected colors and according to the multimedia.

The live word of the teacher is also attached to the process and so we can see two necessary factors for creating the mood, which causes student’s corresponding activity-readiness for gaining and studying the material firmly.

It must also be mentioned that “the mood gaining once, never looses and stays with the person, as the new readiness of actualization, in the new corresponding cases”.

The use of computer teaching programs contains the following stages of perception process [5]:

The aim of the first stage is the forming of the student’s motivation towards the learning topic (material); At this time it is important to prove the necessity of the topic, to display its important features, juxtaposition of the other subjects (connection of different subjects); The whole class will be involved in this process and it would be right if the teacher used the most interesting illustrated computer materials of the topics which would be studied.

Though at this stage the suggested visual aids mustn’t contain the deep contents of the materials which would be studied as this point is the main task of the next stages.

The aim of the record stage is to discuss studying material consecutively and deeply. While teaching the new material it is necessary to use the illustrated materials.

In this case the advantage has goof computer learning programs with the help of which it is possible to keep an aye on the development of the dynamic process of the studying material and in different scales. E.g. The development of different chemical mechanisms on the micro and macro levels of course the continuation of the reactions must be put into the computer models, the performing of which is difficult or impossible for many conditions in the laboratory circumstances.

On the third stage there is a process of perception of already explained material.

It is very important the scientific language of the given subject, the learning of main terms and concepts.

It is also suitable (on this stage) to use the multimedia models which contain especially difficult theoretical concepts. Together with it there must be taken into consideration student's interactive relation towards the studying material in the program maintenances.

Verbal methods are used on the *fourth and the fifth stages*. In this case there also must be used computer illustrated material showed on the second stage. Which must be filled with findings of kindred subjects. The elements of this program must be discussed, debated in the lecture- room.

The last the *sixth stage* is proposed for testing the studied theme. The teacher tests not only the general contents of the material, but the ability of the pupil to join this information with other sciences and use it (the new information) for the solution of the new problems.

Also, I must underline, that in our program chemistry is connected with history of chemistry. We have reviewed periods, when the famous scientists was discovered they openings. Some of the subjects are connected with arts. For example, before studding Structures of Molecules the pupil introduce to "Cubism", where artists use geometrical figures- square, triangle, hexagon. Picasso is the famous representative of "Cubism". The pupils will meet such kind of geometrical figures, when they study Structures of Molecules.

Or, let us speak about *water*. What is water? According to the words of Saint-Exupéry "The basis of life", which has special chemical activity. For visualization consider its action with metals. It reacts very actively with lithium and sodium, potassium burns when touching with water. From what it contains? From hydrogen and oxygen. Both have wonderful chemical biography. The nature water is a part of man's body ( cellular and intercellular). It plays different vital roles and its amount depends on the man's age, on the content of fat. Dehydration sometimes may be mortal for man.

We have spoken about hydrogen and oxygen which are the parts of water. Hydrogen was discovered in 1766 in London by Cavendish. Oxygen was discovered in 1774 by Priestly and Sheele in towns Lids-Upsala. In the block of history the situation in England and Switzerland and the situation in Georgia will be discussed- what was happening in Georgia at that time, which problems (among them-scientific) were to be solved.

This lyrical digression help us to make motivation in pupils.

### Acknowledgements

The author would like to express her appreciation to Rustaveli Fondation for financial support to making educational program in chemistry.

### Literature References

1. D. Uznadze, The Psychology of Mood. Tbilisi 1999.
2. A. Woolfolk, Educational psychology, Allyn and Bacon, Sydney 2000.
3. U. Kask, J.D. Rawn, General Chemistry, Oxsford, England 2000.
4. M. Freemantle, Chemistry in Action, "Mir", Moscow 1991.
5. K. Kapatadze, P.S.J. "Georgia Chemical Journal", 2005, 3(5), 107-118

## Creative Methods for Teaching and Learning Chemistry

**Zafra Margolin LERMAN, Ph.D., FRSC**

*Lerman Institute for the Advancement of Science  
1911 Grant St., Evanston, IL 60201, USA*

*zafra@zafralearnerman.com*

*Phone: (847) 866-7299 Fax: (847) 866-7299*

### Abstract

*Chemistry plays a central role in the world in which we live. For example, global warming, climate change, water resources, and energy sources require a strong background in chemistry and cross-border collaborations in order to solve the serious problems our planet faces. We must guarantee that we have enough chemistry students in the pipeline so they can become the problem-solvers of the future. Sadly enough, chemistry is often perceived with a negative image. However, an effort has been made at the Science Institute during the past three decades to develop creative methods of teaching, learning, and assessing chemistry for all educational levels -- elementary schools, high schools, universities and for the general public. These methods can be used both in formal and informal settings. A Chinese proverb states: "I hear and I forget; I see and I remember; I do and I understand." Creative methods of teaching chemistry take into account this Chinese proverb. The part "I see and I remember" is translated into visualization techniques in chemistry, but the most important part, "I do and I understand," is translated into hands-on experiments. In this method, students produce their own visualization projects in order to communicate their understanding of abstract chemical concepts. These visualization projects can take the form of art, music, dance, drama, computer animations, cartoons and poetry. Examples of a variety of projects will be presented in this symposium.*

**Keywords:** visualization, cross-border collaboration, pollution, alternative assessment, creative method computer animation

Chemistry plays a central role in the world in which we live. Global climate change, scarce water resources, and limited energy sources are serious problems facing our planet, all of which require a strong background in chemistry and cross-border collaboration to solve. One of the problems of the 20<sup>th</sup> century is air pollution, resulting from the rapid industrialization in developing countries. Scientific research shows the relationship between polluted air and common health ailments, such as cancer, asthma, birth defects, and heart problems. Figure 1 shows air pollution in Cairo, Egypt created by a coke and chemical plant. Many people working at this plant suffered poor health effects, including cancer.



**Figure 1** A Cairo, Egypt coke and chemical plant



Because nature and the environment do not recognize the borders established by nations, air pollution crosses borders to pollute the air of neighboring countries as well. Therefore, in order to deal with the issue of air pollution, we must have cross-border collaborations between nations, even if their governments are hostile to each other.

Another critical issue facing the planet is water: water scarcity, water security, and water pollution. Figure 2 shows the leaching of solid waste disposal into the water resource in Gaza. The water pollution in Gaza is so severe that there is no clean drinking water. The chloride content in most wells fluctuates from 400 to 1,000 mg/L, which is much higher than the recommended value by the World Health Organization (WHO), which is 250 mg/L. Nitrate content in the well water is used as an indicator, especially when salinity is low. Nitrate levels in most of the wells are around 100 to 150 mg/L. This value is three times the recommended WHO value, which is 50 mg/L. The high nitrate and saline content results in diseases suffered by many Palestinians today, including blue babies and renal failure.[1]



**Figure 2** Pollution by leaching solid waste disposal into the water

All these global issues can be solved only through collaboration. Figure 3 shows scientists from Syria, Iraq, and Israel discussing a poster titled “Biological Treatment of Refinery Waste Water treatment.” This discussion was made possible through the biennial Malta Conferences, titled “Frontiers of Chemical Sciences: Research and Education in the Middle East.” The conferences bring together six Nobel laureates with scientists from 15 Middle East countries (Bahrain, Egypt, Iran, Iraq, Israel, Jordan, Kuwait, Lebanon, Libya, Palestine, Qatar, Saudi Arabia, Syria, Turkey, and United Arab Emirates) to work on issues of air and water quality, energy resources, sustainability, and science education for all levels.[2]



**Figure 3** Scientists from Syria, Iraq, and Israel discuss a poster on Biological Treatment of Refinery Waste Water

In order to solve the global problems of our planet, we must have students in the pipeline who will become the future scientists equipped with the knowledge and skills to solve these problems. That interest must be generated in elementary school. If the students have already developed hostility to chemistry while they are young, they will fail to choose careers in chemistry, where they can develop solutions to the problems facing our world today and in the future. This hostility is developed as a result of dull, traditional instructional methods, which ignore the students' personal interests, cultural backgrounds, hobbies, talents, and the relevance of chemistry to the students' daily lives.

With the public's negative image of chemistry, students are puzzled why they need to study chemistry when they are bombarded by messages about the negative effects of chemicals on health, the environment, and the creation of chemical weapons. The achievement of chemistry is unknown to the general public and many times teachers do not communicate these accomplishments to their students. The result is a widespread inability to understand the necessity and importance of chemistry for creating a sustainable, peaceful world, which creates a big challenge in the teaching and learning of chemistry.

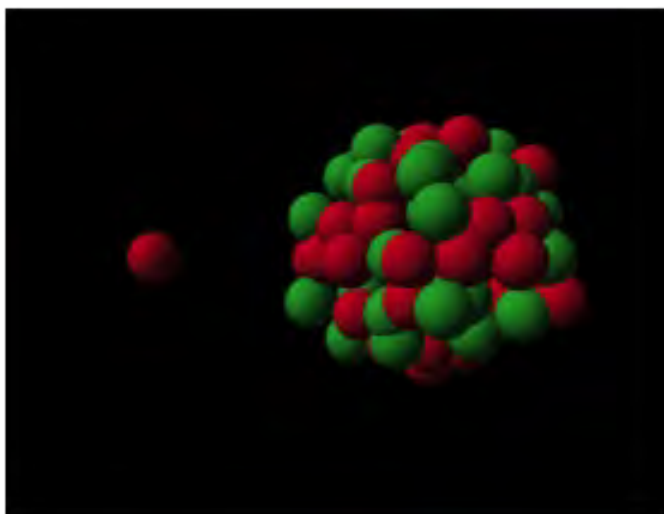
At the Science Institute we succeeded in developing creative methods for teaching, learning, and assessing students, which take into account the students' environment, background, interests, and skills. These methods have been successfully used for three decades in public schools, in universities, and with the general public.[3-4]

In order to show the students the relevance of science to their daily lives, the students are required to bring to class a summary of an article that appears in their local newspaper which deals with a scientific issue. Each student gives a short summary of the article they read and the class discusses the article. From there, it is very easy to connect the scientific subject that is being taught that day to some aspect of the news, thus making the subject much more relatable and relevant to the students. For example, if a student brings in an article about a nuclear power plant, discussions can be had on a number of different subjects, such as how the word "nuclear" is related to the nucleus of the atom. This is a good point to teach the structure of the atom, where the students can see that it's not just something abstract in a textbook, but that it relates to the nuclear power plant story that appeared in the newspaper.

They realize that even to understand an article in the daily newspaper, some background in science is needed. In order to write the article, journalists must also have a background in science. With that, science is not just a subject that is isolated from life, but a subject that is essential even to understanding a newspaper article. The reading of the newspaper articles is being used from 6<sup>th</sup> grade until 12<sup>th</sup> grade and in university classrooms. Not only do students begin to see the relevance of science to their daily lives, but they also get into the habit of reading the science section in newspapers, which they continue beyond the class period.

After discussing a chemistry concept, the students demonstrate their knowledge in any way they feel most comfortable. They can use their cultural background, creativity, hobbies, talents, interests, and any personal expression they choose to illustrate their understanding of the abstract concept. Their visualization projects can be no-tech (dance, drama, art, poetry, music [5]) or high-tech (computer animation). For example, when reading the newspaper article on nuclear power plants, students used different media to communicate the structure of the atom, the nucleus, and the fission reaction, as shown in Figures 4 and 5. Figure 4 is a single snapshot from a movie produced by a student that demonstrates the fission reaction, which leads to the formation of the atom bomb. The movie continues showing the aftermath of dropping the bomb on Hiroshima. Figure 5 shows the fission reaction through dance, where the dancer flying in the air is the neutron that is going to bombard the nucleus. The dance continues to visualize the formation of the atom bomb.

Another scientific concept that was visualized in different ways is the chemical bond. In Figure 6, we see one of twelve comic book panels produced by an art student [6] who showed his understanding of the ionic bond between sodium and chlorine to form salt and the effect of water in separating the sodium ion from the chlorine ion.



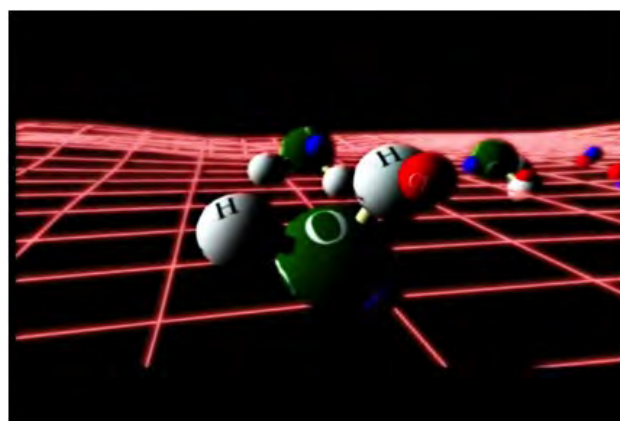
**Figure 4** Computer animation of a neutron bombarding the nucleus of an atom in a fission [7]



**Figure 5** A dance representing a neutron bombarding the nucleus of an atom in a fission reaction [7]



**Figure 6** One page from a computer-generated comic book on the ionic bond



**Figure 7** A computer-generated image of salt (NaCl) in water produced by a student

The same concept is demonstrated in Figure 7, but through a computer animated movie called "Prometheus," where the concept of the ionic bond and the effect of water on ionic bonds is told through the story of a Greek myth. Figure 8 provides another example of the same concept through a drama parodying the popular movie, "The Godfather," but called "The Bondfather" and featuring a mother begging the Bondfather, Don Mendeleev, to break up the bond between her daughter, Chlorine, and her boyfriend, Sodium. The mother says she is afraid that their relationship will be broken in water and she would like her daughter to be in a covalent bond, where she can share electrons with her partner and have a strong bond with him.



**Figure 8** Theater students visualize the chemical bond in a drama called "The Bondfather" in the style of popular American movie, "The Godfather"

An advantage of students presenting these visualization projects is that they understand the concept very well and do not learn just by memorizing a chapter in a textbook and repeating it for standardized tests. Another aspect of this alternative assessment method is that the whole class is assessing the student in a very constructive, collegial, and friendly way. The students usually rate these methods very highly and say that it helps them remember the chemistry concepts for a very long time. Additionally, they use the projects in portfolios for their future employment.

The students also show their visualization projects in events for the general public, which furthers public understanding and appreciation of chemistry. One student, for example, wrote a song about air pollution, which she has continued to perform for live audiences throughout the U.S. and on television.

These methods have received recognition all over the U.S. and around the world and were adapted by many schools and universities. The Secretary of Education of the U.S. (Minister of Education), the Honorable Richard Riley, showed examples of these students' projects communicating chemistry through the arts in a speech given on public television. Twenty million people all over the U.S. viewed the speech on television. It was a big honor for the highest education officer in the U.S. to present our alternative method of teaching, learning, and assessing chemistry to millions of citizens, and he complimented the use of the arts in teaching science as a unique and creative method. [7]

These methods of teaching chemistry were very successful in the informal setting of teaching prisoners, students from very low-income families, and homeless youth who studied dance at night in a dance studio, where they learned chemistry through dance on the floor of the studio. The youth performed their visualization and understanding of chemistry concepts in many scientific conferences around the U.S. Many of them went on to study chemistry and biochemistry in universities, some even going on to attain their Ph.D.

Research conducted on the achievement of hundreds of 5<sup>th</sup> grade science students showed that students whose teachers participated in workshops and adapted these methods in their classrooms scored ninety out of one hundred on a standardized test, compared to a control group of students whose teachers taught in the traditional method. The control group scored below ten out of one hundred. In every school there

was a control class in the same building. The same research for 8<sup>th</sup> grade students showed that the students whose teachers employed these methods scored sixty out of one hundred, compared to fifteen out of one hundred for the control group. These statistics proved the effectiveness of using the arts in the teaching, learning, and assessing of science.

With the exponential growth of the world population, we must guarantee science education to all. Otherwise, we will form a two-class society divided not by royalty and wealth, but by scientific literacy. These methods of teaching and learning fulfills the tenet held dear to me and which prompted the creation of these methods – that equal access to science education is a human right that belongs to all.

### Acknowledgements

Thanks to the National Science Foundation for support of this work through grants ESI-9619141; ESI-9253266; USE-9150524; and TPE-8955128.

### Reference List

1. Z. M. Lerman: Chemistry and Chemical Education as a Bridge to Peace. In: Minu Gupta-Bhowon, Sabina Jhaumeer-Laulloo, Henri Li Kam Wah, Ponnadurai Ramasami (eds.) Chemistry Education in the ICT Age, pp. 1-10. Springer, Netherlands, (2009)
2. Malta Conferences Foundation website. [www.MaltaConferencesFoundation.org](http://www.MaltaConferencesFoundation.org). Accessed 15 September 2012.
3. Z. M. Lerman, J. Chem. Ed, 1986, 63, 142.
4. Z. M. Lerman, Chemical Education International, 2001, 2:1, 6-13.
5. H. Gardner, Multiple Intelligences: The Theory in Practice. HarperCollins Publishers, Inc., New York, (1993)
6. R. Hoffman, V. Torrence, Chemistry Imagined: Reflections on Science. Smithsonian Institution Press, Washington D.C., (1993)
7. Z. M. Lerman, J. Chem. Ed. 2003, 80:11, 1234-1242.

## Creative General Chemistry Experiments with Citrus Fruits

Bih-Show LOU\*, Ching-Fen CHOU, and Chuan-Wei HSU

*Division of Chemistry, Center for General Education, Chang Gung University, Tao-Yuan 333, Taiwan, ROC  
e-mail: blou@mail.cgu.edu.tw Tel: 011-886-2118800\*5018 Fax: 011-886-3-2118700*

### **Abstract**

*We have developed creative variations of three standard general chemistry experiments that use citrus fruits: 1) Exploring the electrical power that can be generated by the pulp, 2) Measuring chemical and electrical properties of the juice, and 3) Discovering a practical and novel use for the peel (only the epicarp). These simple but elaborate experiments provide some proof of fundamental chemistry theories, including a) electron transfer between the anode and cathode (the redox reaction), b) the relationship between conductivity and the concentration of electrolytes, and c) characteristics of substance polarity and solubility. It also introduces the use of pH and multi meters, along with the lab skills of extraction, and data analysis, among others. In addition, practical elements are covered to increase the students' interest, including light and sound effects such as lighting up an LED and making the fruit "sing". Lastly, making citrus detergents will help students be more aware of the issues of recycling and environmental responsibility. In these experiments, students not only understand the necessary scientific knowledge, but also learn common lab skills for making a practical product that has uses in everyday life.*

**Keywords:** Fruit battery, oxidation-reduction titration, essential oil, environmentally friendly, green chemistry.

### **1. Introduction**

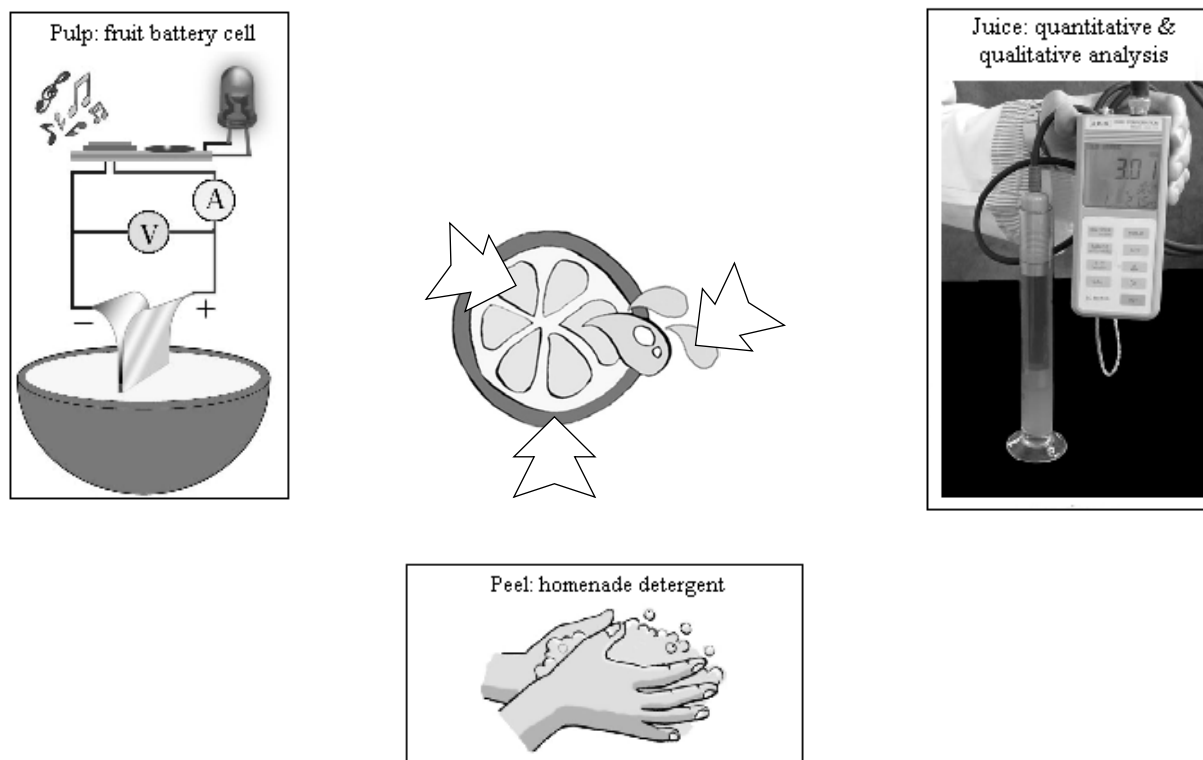
Among all the fruits coming into season through the year, citrus fruits make up the majority of them. These sweet and sour fruits are deliciously juicy and hard to forget. They are also a natural source of many vitamins and minerals, including vitamin C. Other than these benefits, citrus fruits also have hidden properties, which we explored in three experiments designed for general chemistry lab. The first experiment is "Fruit Battery", which applies the oxidation-reduction principle and converts energy from chemical reactions into electrical energy [1]. It demonstrates how electrically powerful a citrus fruit can be. We made comparisons between different fruits, and different electrode cross-sectional areas to generate different electrical charges [2]. In addition, some interesting practical elements are added to increase the students' interest; including audiovisual effects such as lighting up an LED, and making the fruit "sing" using a music chip. These effects help the students to easily recognize the exchange process between chemical and electrical energies. This is, to our knowledge, the very first experiment that uses sound to demonstrate a chemical to electrical conversion process. Also, this experiment encourages students to team up and cooperate. In the teaching lab, our students pioneered the experiment of playing a tune using one fruit battery, and lighting up an LED using two fruit batteries in a series connection.

In our second experiment, we have students squeeze out juice from the citrus left over from the first experiment, and measure pH value and conductivity in different concentrations of fruit juice [3]. Combining these measurements together emphasizes the relationship between these properties, rather than isolating them in different experiments. Several lab skills in analytic chemistry are introduced, including indicator, solution preparation, and pH meter calibration by standard reagents. From examining the results, students learn the correlation between the conductivity of a solution, and its ionic concentration. The purpose of the second experiment is to characterize the properties of citrus fruit juice in both qualitative and quantitative aspects.

Lastly, since citrus fruit peel contains a useful quantity of essential oils and coumarin glycosides [4], which have natural aromas and antibacterial properties, the third experiment is to have students manufa

manufacture a homemade detergent using only the epicarp. The essential oil is extracted by using a 90% ethanol mixture, and can be used for making detergents, air purifiers, sanitizers, etc. Making detergents will cultivate the students' appreciation of recycling and raise awareness of environmental issues. In these experiments, students can not only understand the necessary scientific knowledge, but can also learn common lab skills for making a practical product that has uses in everyday life.

A flowchart for these three experiments is shown in Figure 1, and summarized in Table 1.



**Figure 1** Experimental design three standard general chemistry experiments that use one citrus fruit.

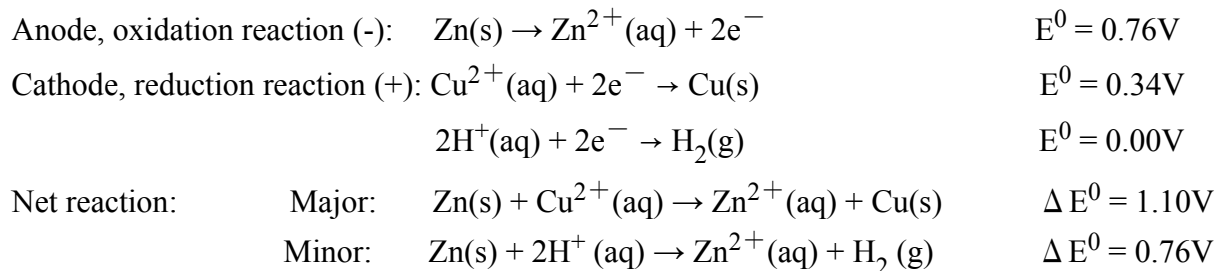
**Table 1** Experimental purposes, theories, and highlights of the Citrus Fruit.

	Pulp	Juice	Peel
<b>Experiment</b>	Fruit Battery	pH, and Conductivity in Citrus	Homemade Zest Detergent
<b>Purposes of Experiment</b>	Discover the factors that affect the electrical power of a fruit battery cell	Measure the qualitative and quantitative properties of citrus juice	A use of fruit peel in everyday life
<b>Experimental Theories &amp; Skills</b>	Redox reaction Electron transfer Reduction potential Electrochemistry	Redox titration Conductivity Data analysis Solution preparation	Extraction Molecular polarity Solubility Solvent property
<b>Experimental Highlights</b>	Illuminate an LED & activate a music chip to play a tune	Observe the relationship between juice concentration and conductivity	Emphasize the concepts of recycling environmental responsibility. A green chemistry experiment

## 2. Experimental Background

### 2.1 Citrus Fruit Battery - The Power of Pulp

A fruit battery is an electrochemical cell [5] and is made by immersing oxidized Cu and Zn metal bars into a conductive material, in this case, fruit pulp. It then becomes an electrochemical cell that provides a current or flow of electrons at a constant voltage, as a result of an oxidation-reduction reaction. The overall reaction consists of two half reactions [6]:



In the cell, two electrodes are physically separated by filter paper, and electrons flow from their source (the oxidation of Zn) through the wire to the electrode, which reduces  $\text{Cu}^{2+}$ . The evidence can be observed by the black surface of oxidized Cu metal covering with shiny Cu metal particle after experiment. Because  $\text{Zn}^{2+}$  is formed in the anode compartment and the  $\text{Cu}^{2+}$  concentration in the cathode compartment is decreasing during the reaction, the charges become imbalanced and the cell won't operate unless the half-cells are neutralized. To allow the cell to operate, a salt-bridge is needed to allow the anion and the cation to flow between anode and cathode to maintain their electric neutrality. The citrus fruits, which are rich in natural electrolytes, function as a salt bridge in this kind of electrochemical cell system. At the same time, a small amount of acidic ions in the citrus fruit were reduced, which corresponds with the Zn that was oxidized. Therefore, a small amount of hydrogen gas was produced in the reaction. By placing a LED or a music chip in the circuit or looking at the voltmeter, we can see that the Zn/Cu<sup>2+</sup> cell generated electrical energy.

### 2.2 Qualitative and Quantitative Properties of Citrus

Conductivity is a property of an ionic solution, and is dependant on the composition of the conductor in the solution. The conductivity,  $\kappa$  (SI unit: siemen, S), of a substance is the reciprocally related to resistance, R (SI unit: ohm,  $\Omega$ ). Usually, the conductivity  $\kappa$  (at 25°C) can be measured by a pair of Pt electrodes, and its relationship with resistance R is defined by

$$R = \frac{L}{\kappa A}$$

Where L (m) is the distance between the two electrodes, and A ( $\text{m}^2$ ) is the cross-sectional area of the electrode. The resistance R depends on both the dimensions and composition of the conductor. R increases with the increasing length of the conductor, and decreases with an increasing cross-sectional area.

### 2.3 A Practical Use of Fruit Peel (Epicarp) in Everyday Life

The peel of citrus fruit contains useful amounts of essential oil, hesperidin, and coumarin glycosides. Essential oils are hydrophobic liquids that contain volatile aromatic compounds that we perceive as the pleasing natural aroma of plants. Essential oils from citrus peel have antimicrobial (i.e. antibacterial, antifungal, antiviral, or antiparasitic) properties, and are used as antiseptics and disinfectants [7-9].



Hesperidin is a bioflavonoid, a water-soluble nutrient, and may also have other benefits, including a purported ability to alleviate hay fever and other allergies [10-11]. Coumarin glycosides are a kind of lactone glycoside, are very fragrant, and have been shown to have antifungicidal, and antitumor properties [4].

Ethanol is a common organic solvent with lower polarity than water, but greater polarity than other organic solvents. With its solvent polarity, ethanol can dissolve non-polarized substances, such as essential oils, lactone, aromatic compounds, and other polarized substances, including alkaloid salt, hesperidin, carbohydrates etc. Ethanol can be mixed with water at various ratios, and the higher concentration of ethanol in the aqueous solution, the lower polarity it has. Therefore, with different concentrations of ethanol in water, we can extract substances with different polarities. After several trials and errors in our lab, we found that 90% ethanol can get the best yield of essential oil and coumarin glycosides from the peel of citrus fruit.

### 3. Experimental Materials and Procedures

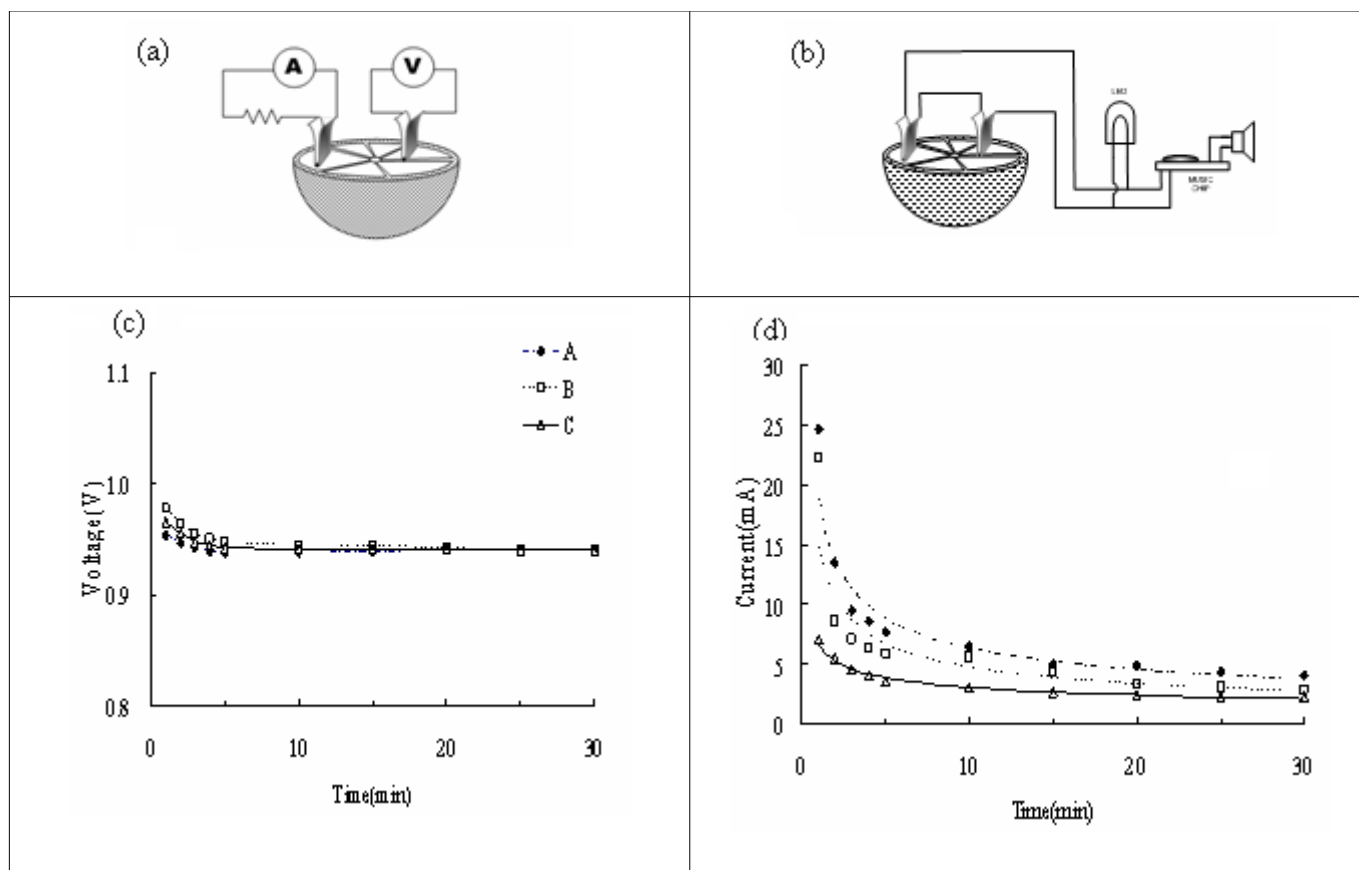
#### 3.1 Citrus Fruit Battery

##### Materials:

two pieces of filter paper, double-headed alligator clips, a LED, a music chip, a fruit knife, two copper plates, two zinc plates, two rubber bands, an alcohol burner, an electric meters, a galvanometer and a citrus fruit (lemon, grapefruit, tangerine, or orange).

##### Procedure:

1. Measure and record the three different sizes of the electrode plates (A:20cm<sup>2</sup>, B:10cm<sup>2</sup>, and C:5cm<sup>2</sup>), and prepare a slightly wider piece of filter paper.
2. Burn both sides of the Cu plate with the alcohol burner to make a copper oxidized layer (black layer) on top of the Cu evenly, and then set it aside to cool down. Also use sand paper to sand off the oxidized layer on the Zn plates.
3. Stack filter paper between the sanded-Zn and oxidized-Cu plates, and then tie those together with a rubber band and bend one end apart into a 'Y' shape. This makes one set of Zn/Cu electrodes. Two sets of electrodes are needed for voltage and current measurements, so repeat the steps to make another set.
4. Cut a citrus fruit horizontally into two halves, and make two slits on the face of each half. Connect the alligator clips to Cu at positive and Zn at negative. Connect one Zn/Cu electrode with a 10Ω resistor and a galvanometer in a series connection, and then record its current. Connect another Zn/Cu electrode with electric meter in parallel for measuring voltage (Figure 2(a)).
5. For each meter, take a data recording every minute for the first 5 minutes, and then every 5 minutes for the next 25 minutes, making the total time 30 minutes.
6. After 30 minutes of data recording, connect the two Zn/Cu sets in series, and then add an LED and a music-chip to the cell in a parallel connection (Figure 2(b)), and observe the device activation, recording the voltage. If the LED does not light up or the music does not play, team up with another group (either with the same or a different type of fruit) and connect two or more fruit battery cells together in series.



**Figure 2** (a) Schematic diagrams for a Zn/Cu electrode and a multi-meter in a series connection for voltage and current measuring;  
 (b) Schematic diagram for Zn/Cu electrode and an LED and a music-chip in a parallel connection;  
 (c) Voltage changes over time for different sized electrodes;  
 (d) Current changes over time for different sized electrodes.

### 3.2 Qualitative and Quantitative Properties of Citrus

#### Materials:

a 50 mL and 150 mL beaker, a Büchner funnel, filtering flask, 50 mL graduated cylinder, funnel, five 50mL volumetric flasks, conductivity meter, pH meter, pipette, an Erlenmeyer flask, buret with holder, pH standard solution, fruit juice.

#### Procedure:

##### A. pH and conductivity of fruit juice

1. After Experiment I, squeeze the fruit juice into a 150mL beaker, filtering out any pulp, and place the filtered juice into a graduated cylinder.
2. Measure and record the conductivity and the pH of pure fruit juice by conductivity meter and pH meter.
3. Transfer 0.5, 1, 1.5, 2, and 2.5mL of pure fruit juice into five 50mL volumetric flask by pipette, and dilute them into 1%, 2%, 3%, 4%, and 5% juice by adding water up to the line marked in the neck of volumetric flask.
4. Transfer the diluted fruit juice into a 50mL graduated cylinder, and record its conductivity and pH with a conductivity meter and a pH meter. Begin measuring from the most diluted juice to the most concentrated one.

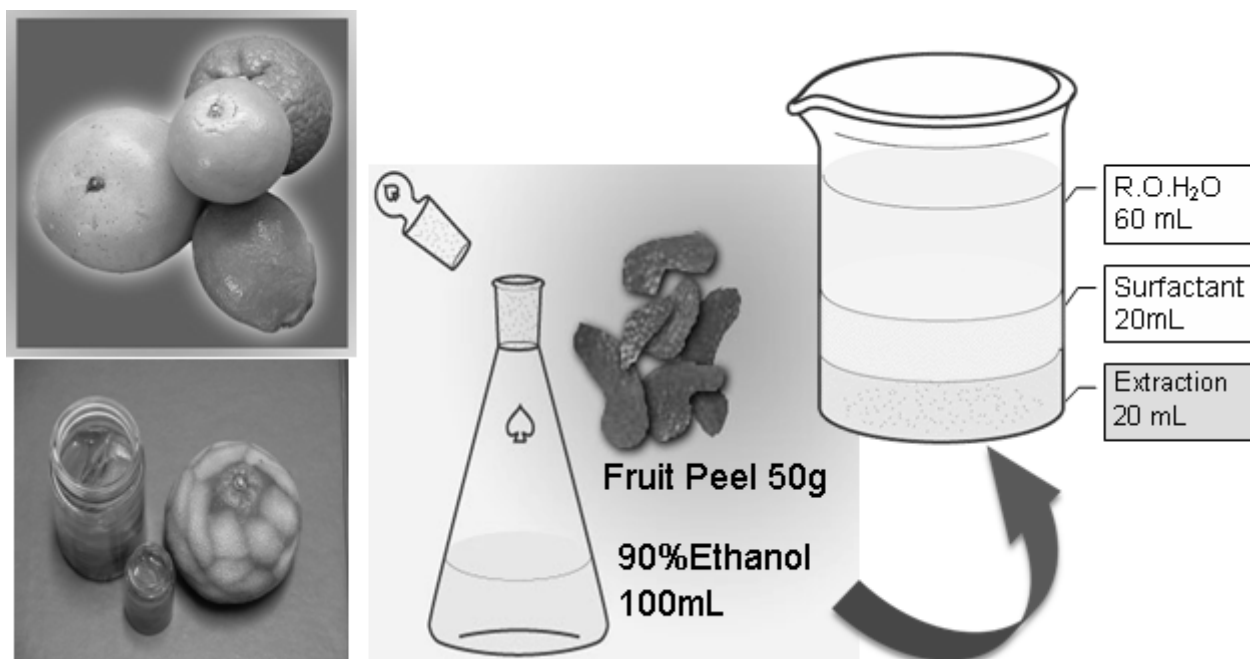
### 3.3 A Practical Use of Fruit Peel for Everyday Life

#### Materials:

a 250 mL bottle, 150 mL beaker, a Büchner funnel, 50mL graduated cylinder, a knife, 90% alcohol solution, fruit peels, natural surfactant: cocamide betaine.

#### Procedure:

1. Clean the fruit with a soft-bristle brush and running water, so that water soluble chemicals and dirt can be washed away. Then dry the fruit and peel it.
2. Soak 50g of citrus peel in 100mL of 90% alcohol solution. After one day of soaking, filter out the peels, and store the extraction in a dark-colored glass bottle to avoid light exposure.
3. Measure 20 mL of the extraction with a graduated cylinder, and transfer it into a clean 100mL glass container. Add 20g of cocamide betaine into the extraction solution, then dilute it with 100mL of water (Figure 3)



**Figure 3** Extraction experiment for citrus's detergent.

## 4. Results and Discussion

The citrus fruits used in our teaching lab were lemons, grapefruits, tangerines, and oranges. Their voltages when used as fruit batteries, pH values and conductivities of fruit's juice at different concentrations are summarized in Table 2. The 1<sup>st</sup> row of Table 2 shows the range of redox potentials for the different types of fruit batteries. The data was gathered from the 52 groups in the three teaching labs. No matter what kind of citrus fruit students used for making the battery, the redox potential fell in the range of 0.91 ~ 0.94 V. The citrus in the fruit battery is considered to act as a salt bridge. It allows anions and cations to flow between anode and cathode to maintain electric neutrality [1-2]. Although the theoretical value is 1.1 V for the Zn-Cu electrode pair, the voltage range reported here is still considered to be in good agreement with the theoretical value. In this experiment, students learned that a good experimental set up could validate the theory at an acceptable quantitative level. In addition, students can discuss possible reasons

why their experimental results had discrepancies with the theoretical data, such as if the oxidized layer on the zinc electrode didn't get removed completely by the sanding process, or if the copper electrode didn't get oxidized completely, or if the contact between the two electrodes was not perfect because of the shape of the electrodes, and so forth.

**Table 2** The voltages, the pHs, and the conductivities of different citrus fruits.

Type of fruit	Tangerine	Orange	Grapefruit	Lemon
Voltage (V) of fruit battery	0.92±0.02	0.91±0.06	0.93±0.02	0.94±0.02
pH of pure juice	4.51±0.22	4.46±0.19	3.30±0.19	2.42±0.13
Conductivity (mS/cm) of 5% juice	0.27±0.04	0.31±0.11	0.36±0.13	0.88±0.19
Conductivity (mS/cm) of 4% juice	0.23±0.03	0.24±0.05	0.31±0.11	0.81±0.05
Conductivity (mS/cm) of 3% juice	0.19±0.02	0.21±0.12	0.23±0.04	0.68±0.05
Conductivity (mS/cm) of 2% juice	0.16±0.06	0.15±0.03	0.16±0.03	0.55±0.06
Conductivity (mS/cm) of 1% juice	0.11±0.04	0.09±0.03	0.12±0.03	0.44±0.06

The voltage and current of the three different sizes of electrodes, A, B, and C, were constantly monitored and recorded during 30 minutes of data acquisition. Figure 2(c) implies that the voltage remains constant and is independent of the size of the electrodes. However, the current increased as the size of the electrode increased (Figure 2(d)).

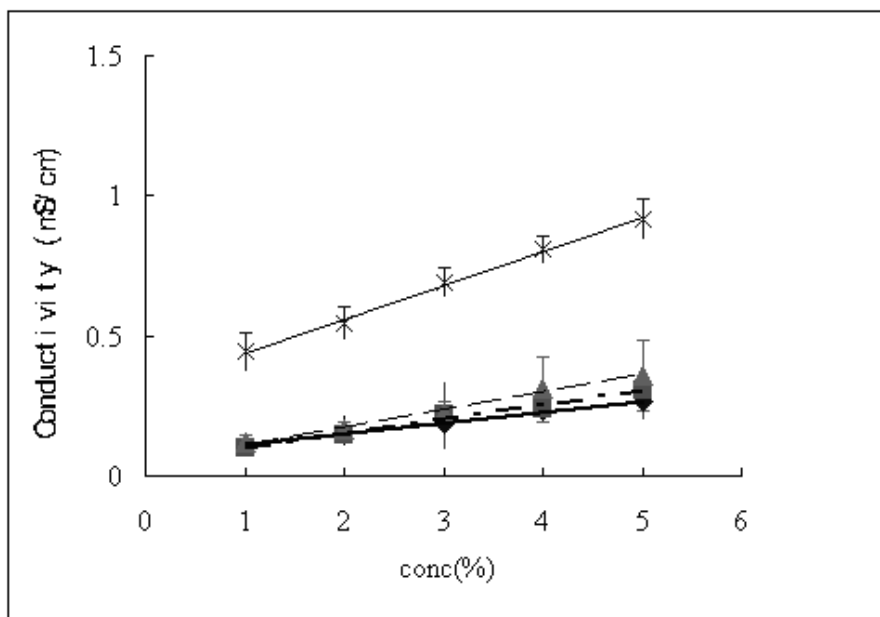
This observation obeys *Ohm's law*:

$$V = IR = I\rho \frac{L}{A}$$

where  $I(A)$  is the current,  $R(\Omega)$  is resistance,  $\rho(\Omega m)$  is resistivity,  $L(m)$  is the distance between the two electrodes, and  $A(m^2)$  is the cross-sectional area of the electrode. This experiment gives students the idea that the bigger the area of an electrode, the stronger a current can be measured. Also, the current weakens as time passes, because the buildup of reaction products on the electrode surface increases the resistance of the battery system [2].

The highlight of this experiment is the light-sound effect. By placing a music chip in the circuit, a musical tune can be played if the battery's voltage reaches 0.8V. This can be achieved by one fruit battery. However, two or more batteries in a serial connection (1.6 V at least) are needed to get an LED to shine brightly. Students all enjoy the first time they get the light to shine and the tune to play.

In the second experiment, students use a pH and conductivity meters to learn how conductivity is affected by the ionic concentration of fruit juice. Per Table 2, students found that lemon juice produced the highest conductivity and had the lowest pH value (conductivity is 0.88 at pH 2.72 in 5% juice solution), and was followed by grapefruit, tangerine, and orange (conductivity 0.36, 0.31, and 0.27 at pH 3.59, 4.66, 4.80 respectively). The lower the pH level of a fruit, the more  $H^+$  ions it contained. In addition, the linear relation between the ionic concentration and the conductivity can be observed as showed in Figure 4.



**Figure 4** Relationship between conductivity and concentration of juice solution.

Last but not least, the bitter peel of a citrus fruit is usually discarded. However, unbeknownst to most people, the peel contains useful amounts of essential oil, hesperidin, and coumarin glycosides. From very positive students' response, we found the citrus-detergent they made from fruit peel in the lab is an extremely efficient cleaning agent that is environmentally friendly, non-toxic and easy to rinse off. It is useful for cleaning fruits, vegetables, and clothing. It also smells much nicer than artificial chemical cleaning agents. This experiment lets students understand molecular polarity and solubility, and also gives them the experience of a green chemical experiment [11] in the lab that can be useful in their everyday life. Also, this experiment will help show students become more aware of the issues of recycling and being environmentally responsible.

**Acknowledgment:** The work was funded by an NSC100-2410-H-182-018 grant to B.-S. Lou.

### References:

1. S. S. Zumdahl, S. A. Zumdahl, Chemistry: An Atoms First Approach, Brooks/Cole, Australia 2012.
2. R. N. Levine, Physical Chemistry, 5th ed., McGraw-Hill, New York, 2002, pp. 387-413.
3. D. C. Harris, Exploring chemical analysis, W. H. Freeman and Company, New York, 2009.
4. D. Chouchi, D. Barth, E. Reverchon, G. DellaPorta, J. Agric. Food Chem. 1996, 44, 1100.
5. L. J. Hendricks, J. T. Williams, J. Chem. Educ. 1992, 69, 655.
6. S. Barrek, O. Paise, M. F. Grenier-Loustalot, Anal. Bioanal. Chem. 2003, 376, 157.
7. G. Ruberto, A. Renda, M. Piattelli, P. Rapisarda, A. Starrantino, J. Agric. Food Chem. 1997, 45, 467.
8. D. Kalemba, A. Kunicka, Curr. Med. Chem. 2003, 10, 813.
9. P. K. Wilmsen, D. S. Spada, M. Salvador, J. Agric. Food Chem., 2005, 53, 4757.
10. A. D. Mauro, B. Fallico, A. Passerini, P. Rapisarda, E. Maccarone, E. J. Agric. Food Chem. 1999, 47, 4391.
11. D. L. Hjeresen, D.L., Schutt, J. M. Boese, J.M. J. Chem. Educ. 2000, 77, 1543.

## Improving The Conceptual Understanding Of First Year Chemistry Students From Resource Disadvantaged High Schools

P.J.J. MARAIS<sup>1</sup>, F. MARAIS<sup>1</sup>, M. POTGIETER<sup>3</sup>

1. Faculty of Science, Tshwane University of Technology, Private bag X680, Pretoria, 0001, South Africa.

maraispjj@tut.ac.za; +2712 3826208; +2712 3826210 (fax)

2. Department of Chemistry, Tshwane University of Technology, Private bag X680, Pretoria, 0001, South Africa.

3. Department of Chemistry, University of Pretoria, Private bag X20, Hatfield, Pretoria, 0028, South Africa.

### Abstract:

*The majority of first year students at Tshwane University of Technology (TUT) come from schools in rural areas where chemistry laboratories are a rare commodity, running water and electricity are not always available and teachers are often not well qualified in Chemistry. Based on school performance, students are split into two different groups with those who achieved the lowest scores being placed in an extended programme. Mainstream students are expected to complete Chemistry 1A over one semester while those accepted for the extended programme receive additional support and complete the same subject over a year.*

*The purpose of this study was to determine the conceptual knowledge profile of first year students and to compare the gains achieved by those who completed Chemistry 1A over a semester with those who completed the same work over one year. A standardised Chemical Concepts Test was applied as both pre- and post- test before and after completion of formal teaching. The normalised gain in conceptual understanding for semester students, taken as an overall average, was 14%, while students in the extended programme achieved a 25% gain. The correlation between post-test performance and performance in the final examination for the respective chemistry modules was compared.*

### Key words:

First year chemistry; conceptual knowledge; resource deficient high schools; normalised gain

### 1. Introduction

The poor success rate for the first year subject Chemistry 1A at Tshwane University of Technology (TUT) has been a matter of concern for several years. Every year since 2007 mastery of chemistry concepts was assessed during the first week of lectures using Mulford's 2002 concept inventory [1]. Where areas of concern were identified targeted interventions were applied which included additional tutorial sessions, worksheets used together with tactile models as well as computer accessible quizzes and tests [2]. During the last week of formal lectures the same test was repeated, but only isolated and limited success, in those areas specifically targeted, was achieved. Little improvement of the poor success rate had been achieved. In January 2011 an extended programme was introduced which allowed students a full year rather than the six month semester in which to complete all their first semester subjects, including Chemistry 1A. This allowed the researchers to compare the gains achieved by students who completed Chemistry 1A over six months and over a year using a more comprehensive chemistry concepts test [3] which covers all the sections of chemistry which, prior to January 2011, had to be mastered during the first semester.

### 2. Theoretical framework

A constructivist theoretical framework was followed during this study since it is centered in the way in which students construct their own knowledge.

### 3. Research questions

What is the entry-level conceptual profile of first-year chemistry students at a South African university of technology?

What gains in conceptual and skills development can be achieved in one semester of tertiary instruction?

Are similar gains achieved when the programme is extended over a year?

Is there any relationship between performance on a conceptual test and examination results?

To what extent is knowledge construction facilitated by extending the programme over a year?

### 4. Methodology

The research design and methodology applied in this project is centered on pre- and post-testing of all first year students. The initial test results were used to determine the conceptual profile of all students before commencement of formal lectures and again after completion of either the first semester (mainstream students) or the first year of study (extended programme students). The difference between the initial and the post-test was used to determine the gains achieved by the different groups of students.

The relationship between performance on a conceptual test and final examination results was measured by comparison of the post-test and final examination scores of both the mainstream and extended programme students.

### 5. Results

In South Africa the entrance requirements for a university of technology, such as TUT, are lower than those of traditional universities so it can be expected that the conceptual knowledge profile of first year students may differ. By using the same concepts test[1] a comparison could be made between the first year chemistry students at TUT with those of two traditional universities. These results are shown in Table 1.

**Table 1:** Conceptual knowledge of first year chemistry students at different universities

<b>Chemical concepts</b>	<b>UP 2009[3]</b>	<b>UCT 2009[3]</b>	<b>TUT 2011</b>
<i>Topic</i> -subtopic	Pre-test (%)	Pre-test (%)	Pre-test (%)
<i>Basic concepts</i> -Atoms&ions	54.8	60.1	41.1
Mole concept	40.2	44.6	29.0
Phases of matter	52.4	50.7	27.9
Solutions	46.0	45.3	31.8
Reactions	28.3	28.3	22.9
<i>Special topics</i> -Acids & bases	33.0	27.6	21.3
Chemical equilibrium	50.4	43.0	28.8
Electrochemistry	36.1	40.6	29.4
Organic chemistry	53.9	56.1	49.6
<i>Process skills</i> -maths skills	42.2	45.4	30.4
Language (& other) skills	37.0	40.2	21.4

The differences in conceptual knowledge profile are consistent with the different entrance requirements. The students initially selected to complete Chemistry 1A over a year had achieved lower scores in their final exams at high school and their pre-test scores were expected to be lower than those of the semester group. A comparison of the pre- and post-test scores of students completing Chemistry 1A, presented in Table 2 clearly shows the improvement of conceptual knowledge in each subtopic attained by students taking the subject over a year compared to those taking it over a semester. In spite of having achieved lower scores both in their high school final examinations and in the pre-test all the post-test scores, except for one subsection, solution chemistry, are markedly higher than achieved by the semester group. The weighted average score is also higher for the students who studied over a year.

**Table 2:** A comparison of pre- and post-test scores of 2011 semester and year students

Chemical concepts	Chemistry 1A (semester)		Chemistry 1A (year)	
	Pre-test (%)	Post-test (%)	Pre-test (%)	Post-test (%)
<i>Basic concepts-Atoms&amp;ions</i>	46.6	48.2	33.1	59.2
Mole concept	27.4	42.4	29.6	53.3
Phases of matter	28.6	29.7	25.6	33.1
Solutions	30.1	43.1	24.1	39.7
Reactions	27.4	25.3	21.1	30.0
<i>Special topics-Acids &amp; bases</i>	22.9	52.3	16.6	58.4
Chemical equilibrium	25.7	34.8	27.8	37.5
Electrochemistry	30.8	34.8	27.8	37.5
Organic chemistry	56.0	54.9	45.9	63.4
<i>Process skills-maths skills</i>	33.7	40.1	23.1	71.5
Language (& other) skills	23.6	27.2	14.5	28.6
<b>Weighted average (%)</b>	<b>32.1</b>	<b>40.1</b>	<b>27.9</b>	<b>46.4</b>

Finally it is useful to compare the gains in conceptual knowledge which were achieved over a semester with those achieved in a year by what was regarded as the weaker group of students. Table 3 illustrates the substantial improvement in conceptual knowledge when Chemistry 1A tuition is extended over a year.

**Table 3:** Comparison of gains in conceptual knowledge between 2011 semester and year students

Group	Pre-test	Post-test	Difference (raw scores)	Normalised gain[4]
Chemistry 1A (Engineering)	37.7	42.6	4.9	7.9%
Chemistry 1A (Science)	28.8	38.8	10.0	14.0%
Chemistry 1A (Extended)	27.9	46.4	18.5	25.7%

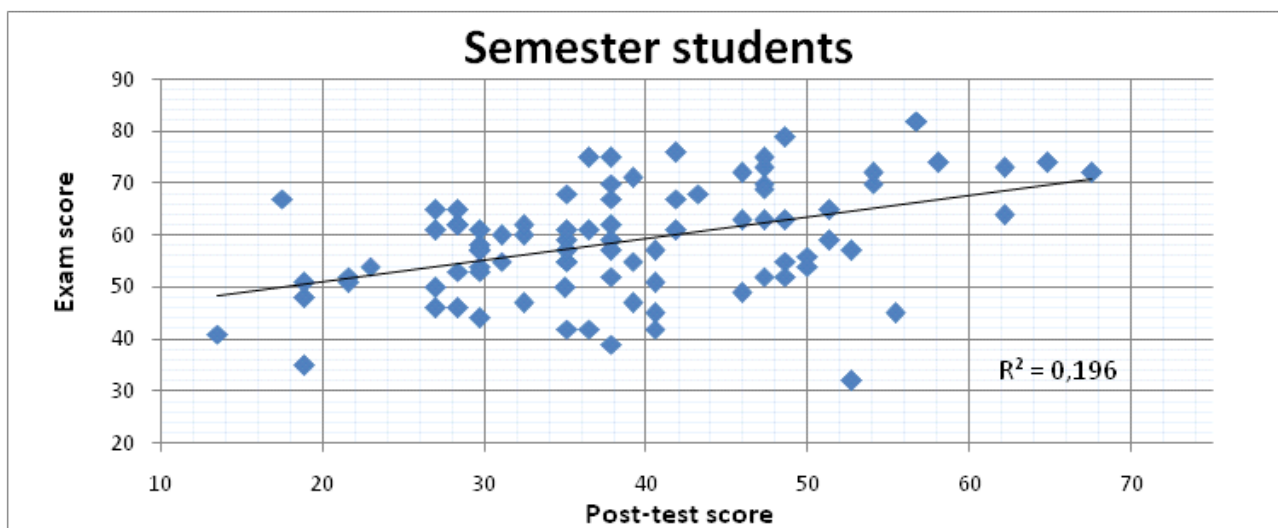
## 7. Discussion

The performance of students entering universities of technology, such as TUT is clearly lower than that of students selected for more traditional universities and is, on average, more than 10% lower. The most dramatic difference is noticed with basic concepts of atoms and ions and phase changes, which is disturbing because these concepts are often just revised during the first week of lectures and assumed to be understood when commencing university studies.

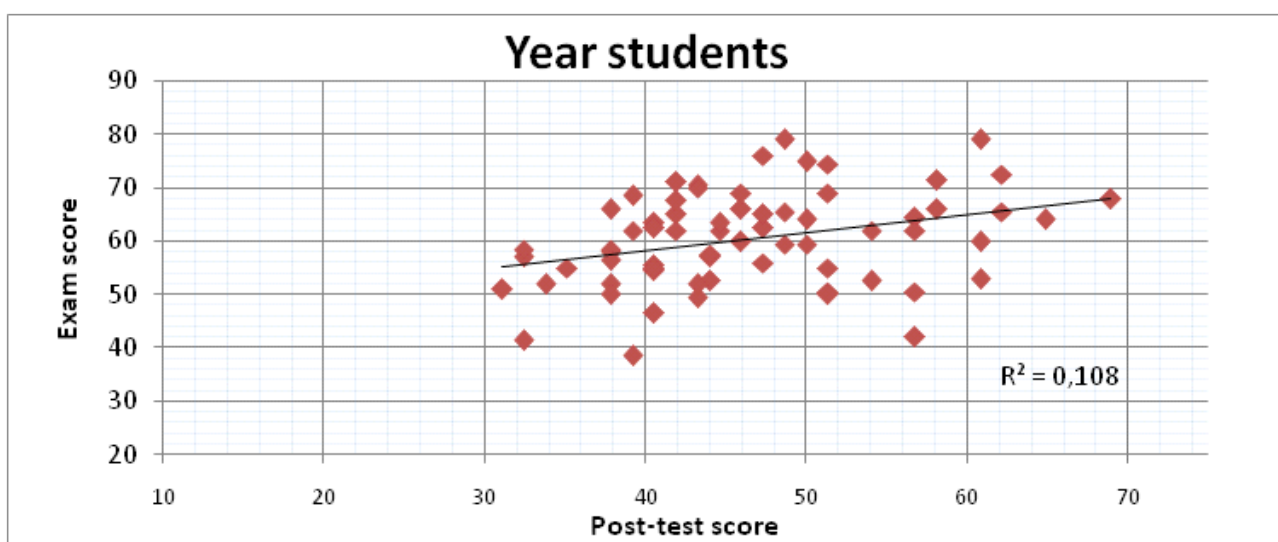
Students selected for the extended programme had more time during the year to target the areas of fundamental knowledge which were not adequately understood. This was highly valuable because many of the schools, especially in rural areas of South Africa, have limited resources. Although these limits include lack of reliable power supply and running water, poorly qualified science teachers present the biggest problem. Many students are accustomed to memorising formulae, definitions and worked out answers to general questions but struggle to apply their knowledge to slightly different problems. Pre-test performance of extended programme students was about 26% which is very close to the random guess level for the multiple-choice items in the instrument. The much improved gain when compared to mainstream students is therefore remarkable. However, a post-test score below 50% for both groups is still a matter of concern, it is comparable to pre-test performance at UP and UCT.

Figures 1 and 2 show the correlation between post-test and final examination scores which, although more scattered for semester students, both groups showed that higher post-test scores generally resulted in higher final examination scores.





**Figure 1** Correlation between post-test and final examination scores for semester students



**Figure 2** Correlation between post-test and final examination scores for year students

## 8. Conclusions

The results found in this study indicate that students who have more time to consolidate their knowledge are more likely to overcome their weak conceptual understanding of chemistry. It is evident that students with higher school exit level scores, who qualify to study chemistry at traditional universities, are better equipped to complete chemistry 1 over one semester. The majority of students who commence their tertiary chemistry studies at TUT will benefit from taking the course over an entire year rather than just one semester.

## Bibliography

1. Mulford, D.R. and W.R. Robinson, *J. Chem. Educ.*, 2002. **79**: p. 739-744.
2. Marais, F. and S. Combrinck, *S. Afr. J. Chem.*, 2009. **62**(1): p. 88-92.
3. Potgieter, M. and B. Davidowitz, *S. Afr. J. Chem.*, 2010. **63**: p. 75-82.
4. Hake, R.R., *Am. J Phys.*, 1998. **66**: p. 64-74.

## Case Study in the Teaching of Chemistry: The soil of coffee trees

**Lia Mara SILVA MARCONDES, Keila BOSSOLANI KIILL, Márcia Regina CORDEIRO**

*Federal University of Alfenas, Institute of Chemistry, Gabriel Monteiro da Silva St., 700,*

*ZIP-CODE: 37130-000. Alfenas-MG, Brazil.*

*Phone: (35) 3299-1000. Fax: (35) 3299-1063*

*Contact information – Phone: (35) 8863-4585 and (35) 3713-1684.*

*Email: lia-marcondes@hotmail.com.*

### Abstract

*Methodology Problem-Based Learning is a teaching strategy that aims to simulate students contact with real problem, involving the content that is being studied and that in future there may exist. The case study method is a variant of this method. The case study is a method of teaching that provides students with the opportunity to direct their own learning and to investigate the scientific and socioeconomic implications of real cases. The objective of this study was to evaluate the contribution of one case in search to improve the students argumentation with the models of Toulmin provided them. We analyze these models with the methodology proposed by Edurand et al., which says the greater the number of components, the more elaborate the arguments. Within this perspective, there is combination of kind "CWB" and "CDWB". We concluded that this method of case study contributes to the argument and the method associated with the experimental activity left the students excited. This did not occur with the conventional academic material.*

**Keywords:** Case Study, Experimentation, Argumentations and Toulmin's Argument Pattern.

### Introduction

The Methodology Problem-Based Learning is a teaching strategy. The created with the aim of giving students contact with real problems involving content that is being studied and that in future there may exist. The case study method is a variant of this method. Case study is a method of teaching that gives students direction in their own learning and investigation of the scientific and socioeconomic aspects of real or fictitious situations at various levels. In this method, it is the use of narratives (case) on problems that needs to be resolved. Students must make decision and seek solutions [1,2].

The case study combined with experimentation in undergraduate laboratories leaves students more interested, and gives them the opportunity to be involved with real problems. This leaves them intrigued by the complexity of a seemingly simple question.

In a publication about a case that used laboratory experiments, it was intended to make it more attractive and challenging. The case was of a boy who was found dead in the river Thames in London. To resolve the case, students have to find the cause of death by analyzing the concentration of strontium present in the bones of the victim. Students who decided the case found the story very interesting and exciting. The generated extremely positive results in relation to learning and interest in Analytical Chemistry Experimental [3].

The case "The Bridge of Mandolin Count" is an example used at the beginning of first semester General Chemistry course. It covers chemical principles, such as molar mass, ions, solubility rules, stoichiometric calculations, among others. In it, students assume the role of members of a municipal council who must decide on the efficiency of two defrosters, used for the construction of a bridge that would give access to the nearby town. The case includes four optional experimental activities, to be performed together to provide the essential information to get to a resolution. The students' answers to this case were satisfactory. They were able to engage in a real problem and were intrigued by the complexity of a seemingly simple question. Also, they showed positive results compared to experimental activities used in solving the case [4]. We chose this theme because in the last two decades research on argumentation in

science education has been intensified and the importance of introducing argumentative discourse for teaching has been highlighted. This practice enables students to understand scientific concepts and understand the nature of knowledge construction [5].

We combined methodology with experimentation to stimulate research questions of real and contextualized problem. Responses to the challenge that must be resolved by testing hypotheses and any incompatibility between students reasoning and scientifically accepted [6]. The argumentative discourse of the students used the Toulmin's Argument Pattern (TAP), relating the different components of the argument: data collection (D) warrants (W) reaching conclusions (C) determining if justifications rely on backings (B) or not, the use of qualifiers (Q) and refutations (R) during the presentation of arguments [8].

### **Objective**

The objective of this study was to evaluate the contribution of the case entitled "The soil of coffee trees", coupled with trial investigative nature, in search of improving argumentation skill of high school students with Toulmin's model.

### **Methodology**

This study aims to evaluate the contribution of the case designed to promote the skills of argumentation and the development stages of the study. They: (a.) preparing the case entitled "The soil of coffee trees", using aspects considered for the elaboration of a "good case" in the understanding of Herreid [7]. (b.) application of the case, with 27 students in a Brazilian public high school, in the form of small group activities, which possessed a narrative that worked in collaboration and relation to the social background of the students. The relevance of this study is done to the large number of coffee producers in the region that influence of the local economy. After researching the topic and discussing, the students in the groups reported their ideas on the problem. They then added new information with the materials that were given to carry out the experiment (if necessary), leading to further discussions and so forth. In experimental activity the students received three soil samples with pH indicator in tubes supported in a tube rack. They were provided a sample with an acid pH, one neutral pH and other alkaline pH, the students also received acidic and basic solutions that were not named, in a way investigative. Finally the students built a TAP using the research done on the case. (c.) data analysis, evaluating the quality of students' TAP considering how students relate the different components of the argument, the establishment of justifications to reach conclusions, if these justifications are based on basic knowledge or not, and the use of qualifiers and rebuttals during the presentation arguments. We adopted the methodology proposed by Erduran et al.[9], whereby the quality of an argument is evaluated based upon the observation of different combinations of components in argumentative speech of students. In this perspective, there may be combinations of double, triple, quadruple or quintuple of components of the Toulmin model of argumentation, as indicative to the increasing order of complexity of the argument.

### **Case: The soil of the coffee trees**

Alfenas, Minas Gerais, is a city of about 70,000 habitants, is a traditional agro-pastoral center and a large coffee producer. About a year ago strange behaviors have been identified in the growth of trees in some farms in the region, threatening conditions of planting and causing a financial crisis for producers who have invested with the expectation of return.

Benedito, director of the Association of Coffee Growers Certificates Of Alfenas And Region (Ascafea), is an influential landowner affected by the strange behavior who suggests that those at risk join him to resolve the problem before it's too late. Benedito has always lived and studied in Alfenas, where he completed high school with two childhood best friends Joaquim and Fernando. After many years of friendship, each one followed a path, Benedict took care of a large coffee farm inherited by his father, Fernando studied BS in chemistry at the Federal University of Alfenas and is currently working in the factory Alcoa Aluminum S. A. in the city of Poços de Caldas and Joaquim studied in Biology in the same faculty as Fernando, but did not become a biologist and became a merchant.

While visiting his family in Alfenas, Fernando rejoined his old friend on a tour in the town square and

was briefed on what was happening in the coffee plantation of some producers in the region. Fernando outraged at what was happening and worried about Benedict sent an email to Francisco, a friend from college and son of a farmer well known in the region of Mogiana Paulista, also a traditional region in the cultivation of coffee:

“Hello, Dear Friend,

We haven't seen each other in a while have we? I'm trying to find a few days to visit you because I miss our talks and the turmoil of college.

I am writing this email because I need your help. My old friend from childhood, Benedito, remembers? He's in trouble at his coffee plantation, he said the problem is with the soil pH that's low.

I remember you once mentioned that your father had this problem, I ask you to ask your father and advice Benedito on what to do.

Att, Fernando.”

*You are the father of Francisco and will have to help Benedito by proposing solutions to solve his problem with the ground of coffee.*

## Results

Of the four groups formed, the combination “CWB” was used by two groups that did not collect the data or included it in their arguments, which are based on low chemistry knowledge and mostly in basic skills. Arguments like “CDWB” were used by the two remaining groups, which could relate to the three fundamental elements, the data (D), the conclusion (C) and the warrants (W), and still included basic knowledge, with the objective of supporting the justification. Figure 1 illustrates two examples of the models delivered by the students, one for each combination:

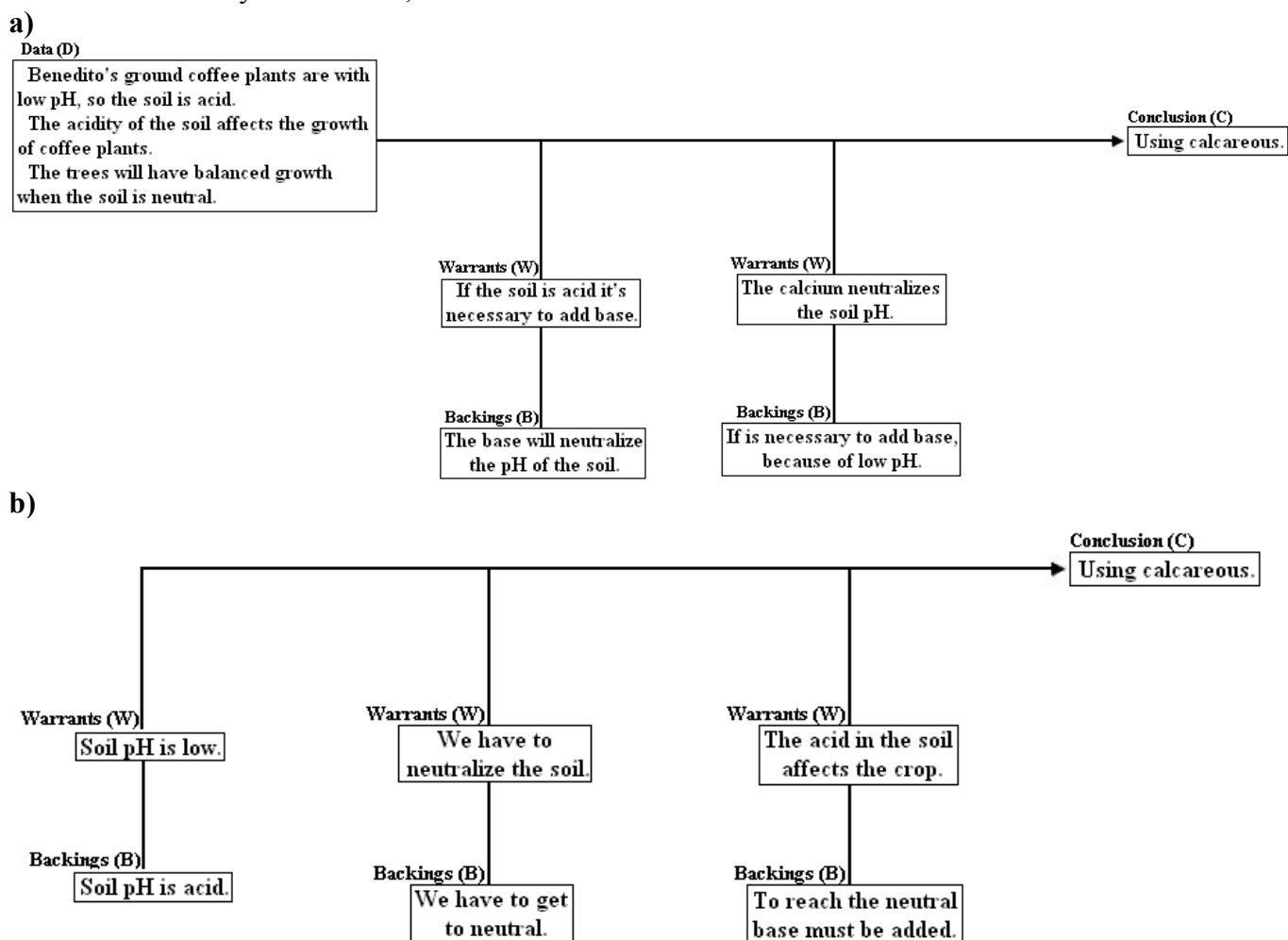


Figure 1. a) Combination “DCWB”; b) Combination “CWB”.

It was observed that all groups showed difficulties in making the distinction between data and warrants and justification and basic knowledge for students to include these components in their arguments.

### Conclusion

In conclusion, the case contributed to improving the argumentation skills, as all groups linked at least three elements of the Toulmin model and half of them used the key elements, "DWC". The method associated with the experiment left the students excited, which, according to the teacher, did not occur with conventional academic materials, producing extremely positive results in relation to student learning. The premise of case-study teaching is that students will respond to material that is placed in the context of an appealing story with more interest and enthusiasm than would result if the same material were presented in a conventional, dispassionate, academic manner.

### Acknowledgments

Thanks to Universidade Federal de Alfenas (Unifal-MG) and Programa de Formação Continuada de Professores de Química (ProfoQui).

### Citation

- [1] L. P. Sá, S. L. Queiroz. 2<sup>a</sup> Ed. Campinas: Átomo, 2009.
- [2] L. P. Sá, C. A. Francisco, S. L. Queiroz. Química Nova na Escola, v. 30, n. 3, p. 731-739, 2007.
- [3] F. J. Dinan, S. H. Szczepankiewicz; M. Carnahan, M. T. Colvim. Journal of Chemical Education, v. 84, n. 4, p. 617-618, 2007.
- [4] J. M. Lantz, J. E. Feindt, E. P. B. Lewellyn, M. M. Journal of Chemical Education, v. 76, n. 12, p.1671-1672, 2000.
- [5] L.H. Sasseron; A. M. P. Carvalho. Ciência & Educação, v.17, n.1, p.97-114, 2011.
- [6] C. C. Guimarães. Química Nova na Escola, v. 31, n. 3, p. 198-202, agosto, 2009.
- [7] C. F. Herreid. Journal of College Science Teaching, v. 27, n. 3, p. 163-169, 1998.
- [8] S. Toulmin. São Paulo: Martins Fontes, 2001.
- [9] S. Erduran, S. Simon, J. Osborne. Science Education, v. 88, n. 6, p. 815-933, 2004.

## Progressive transition of chemistry teachers' models of chemical kinetics teaching based on the study of historical development of this subject

Simone MARTORANO Alves de Assis<sup>1</sup>; Maria MARCONDES E. Ribeiro<sup>2</sup>

<sup>1</sup>Chemistry Department, Londrina State University, Londrina, PR, Brazil, E-mail: simone.martorano@uel.br;

<sup>2</sup>Chemistry Institute, University of São Paulo, São Paulo, Brazil, E-mail: mermarco@iq.usp.br

### Abstract

*Chemical kinetics in high school is regarded by teachers as a complex topic to be taught, since it requires theoretical models (including mathematical models) and empirical approaches. The aim of this study is to investigate how a historical approach can facilitate progressive transitions in chemistry teachers' models of teaching chemical kinetics taking into account their decisions about selecting the content and the teaching strategies. A 40-hour course on chemical kinetics in the historical development of this theme, offered 18 in-service teachers and two graduate students. The course aimed at promoting the understanding of the historical context in which the kinetic concepts were developed. The evolution of the teachers' models were related to their understanding of specific contents in chemical kinetics, as well as the comprehension of the historical development of chemical kinetic concepts and models. Taking as a basis the idea of Progressive Transition from Niaz, it is observed that the course facilitated the smooth transition, especially in understanding the concepts of reactive chemical kinetics. Use of models in explanations of submicroscopic teachers: only when explicitly requested. Transition state theory: difficulty in working with models that include the use of the concepts of chemical bonding and potential energy.*

**Keywords:** Chemical kinetics, History of Science, Progressive Transition, Chemistry Teacher.

### Introduction

Commonly, the teachers of chemistry at school believe that their students cannot learn certain concepts in chemistry because they begin high school with many misconceptions and gaps in their learning, such as, difficulties in interpreting graphs, tables, experimental data, and interpret the statements of simple exercises. These difficulties have been reported in many studies (Justi and Ruas, 1997; van Driel, 2002; Geban and Kaya, 2012; Bektasli and Cakmakci, 2011; Cakmakci et al, 2005) and, on top of it, the difficulty in understanding concepts, for example, interpretation in terms of the microscopic field (Pozo and Crespo, 2009). According to these authors, many individuals are struggling to understand the matter as discontinuous and apply spontaneously the corpuscular model in their explanations regardless of level of education received. However, understanding the discontinuous nature of matter, as well as the use of a corpuscular model, is essential for individuals to understand and interpret many phenomena that occur in the world they live.

Currently, in high school, chemical kinetics has been described by teachers as a difficult subject to approach, because of the empirical and abstract nature of this theme. The comprehension of the rate of a chemical reaction involves the interpretation of experimental data and understanding of the dynamic nature of particles. Thus, the student must move between the microscopic and the macroscopic world, which requires a more complex understanding of the nature of matter.

Considering these difficulties the aim of this study is to investigate how a historical approach can facilitate progressive transitions in chemistry teachers' models on chemical kinetics teaching, taking into account their decisions about the content selection and teaching strategies.

According to Pozo and Crespo (2009), the study of science from a historical approach can provide students with the opportunity to use procedures that are similar to those used in scientific research (develop and verify hypotheses, measure, compare models), but also to use specific procedures not usual in scien-

ce, such as how to read and understand scientific texts, graphics decoding, communicate their ideas and knowledge.

Current researches in science education, focusing on teaching and learning of scientific concepts, have emphasized the importance of history and philosophy of science in this process (Gonzalez, 1994; Justi, 1997; Cachapuz, 1994, 2002, Niaz, 2009, Porto, in 2010). According to Porto (2010), the study and discussion of historical events can release the students from inadequate views about the nature of scientific knowledge, such as the idea that there is a single "scientific method".

Therefore, this paper focuses on the history of chemistry, specifically on how the historical development of chemical kinetics can contribute to the teaching of chemical kinetics, but also in building a vision of science in line with the philosophy of science.

## Methodology

This research involved the intervention of the author as well as a researcher and teacher in a course of continuing education provided to chemistry teachers of a typical high school, Brazil. In this course, a differentiated approach to the subject chemical kinetics was presented, focusing on the historical development of this theme (historical reconstruction), thus allowing a better understanding of the context in which these concepts were developed.

A 40-hour course focused on the historical development of chemical kinetics was offered to 18 in-service teachers and two graduate students. Teachers are identified in this work by T (teacher) followed by a number assigned to them (T1, T2, Tn). Audio and video recordings were made for the teachers' responses to various situations: contribution of lessons and experiments, group discussions, use of multimedia. Data from diverse instruments were collected: questionnaires, concept mapping, analysis of textbooks, development of teaching plans with the historical approach on chemical kinetics.

### • *Models for chemical kinetics teaching:*

Science program perspective, (Lakatos, 1998), it was built models for chemical kinetics teaching based on the teachers' conceptions manifested by their answers to the course activities. We look for models which represent sequences of progressive transitions similar to what Lakatos (1998) has referred to as "progressive problemshifts" in the history of science.

The evolution of the teachers' models were related to the understanding manifested by them of specific content of chemical kinetics as well as the comprehension of the historical development of chemical kinetic concepts and models.

Construction of teaching models of chemical kinetics (CK), table 1, from the ideas of these teachers, verifying the sequences of a gradual transition.

**Table 1.** Models of teaching on the subject chemical kinetics.

Teaching Model (CK)	Description
MMT: teaching model macroscopic	Teaching based on macroscopic characteristics, focusing only on factors that may influence the rate of a reaction.
MPT: teaching model pseudomicroscopic	Teaching based on macroscopic characteristics, however, in their explanations and strategies are beginning to appear the use of terms related to the characteristics of submicroscopic matter, as, for example, movement of molecules and particles shock
MST1: teaching model submicroscopic 1	Statements appear related to theoretical models to explain the rates of reactions and the factors influencing them in terms submicroscopic. The theory used is the theory of collisions.
MST2: teaching model submicroscopic 2	Explanations related to appear theoretical model to more elaborate than the previous model. The theory used in their explanations and strategies is teaching the Theory of the State Transition.

● *Image on the nature science*

As Praia and Chachapuz (1994), the image of science that the students have depends, sometimes, from what is provided by their science teachers, and understandably increased interest in educational research for teaching science an epistemological point of view. According to the authors, there is now evidence that teachers' conceptions about the nature of science, scientific knowledge and method, influences the way to address a particular content and therefore the image of science conveyed to the student.

For the analysis of teachers' responses were used three categories (Table 2) that are related to two philosophical perspectives, the perspective Empiricist / inductivist (E / I) and the prospect Rationalist (R) developed by Martorano (2007), based on the ideas of Lakatos (1998).

**Table 2.** Categories to identify the philosophical perspective of teachers (Martorano, 2007).

Categories	Empiricist / inductivist	Rationalist (Lakatos)
1 - Concept of Science	Set of universal statements.	Modifiable set of hypotheses, organized and tend to make a description of reality. Humana Building.
2-Development of Science	The development of science is presented in a continuous and cumulative way.	The progress of science is characterized as a "progressive issue" of a theoretical attempt to another.
3 - The building of scientific knowledge	From experimental data, to draw up hypotheses that become theories and later become law, according to the amount of "evidence behind the idea."  The observation is regarded as the most important stage of the scientific method.  The role of experiments is the confirmation of knowledge.  The role of scientists is to induce and establish empirical evidence of laws and principles.	The knowledge is constructed based on theories underlying the observation, in other words, an observation depends on theory.  The scientific method is not understood as a linear succession of steps, but rather a process leading to the development of successively more complex ideas.  The role of scientists is to establish hypotheses and develop rational explanations (deductive).

## Results

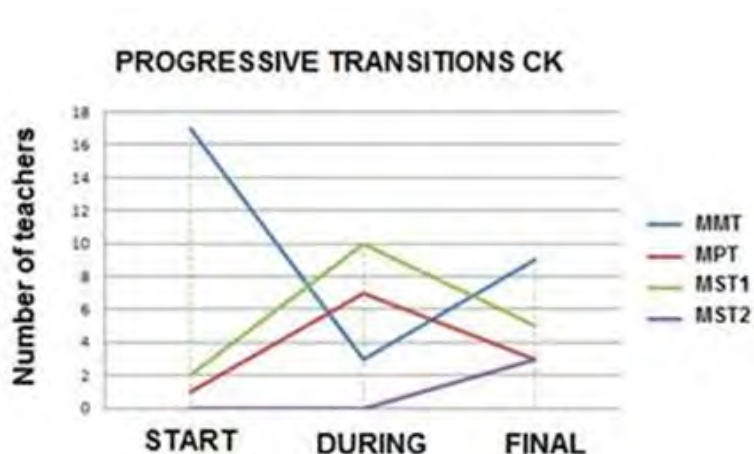
In the beginning of the course, the teaching models were mainly based on macroscopic aspects of chemical kinetics like the factors that affect the rate of chemical reactions.

According to researchers (Justi and Ruas, 1997, Perez, 2006; Cakmakci et al, 2005), this difficulty in working with a submicroscopic model in the teaching of chemical kinetics, can be related to some understanding of that content. Many teachers who attended the course said they have no proper training in relation to chemical kinetics, due to faults in their undergraduate courses.

During the course (graphic 1), 10 teachers have already started using theoretical models involving the submicroscopic aspects (theory of collisions). However, seven teachers used in their explanations, only terms related to the particles, such as molecules, without associating them with a theoretical model.

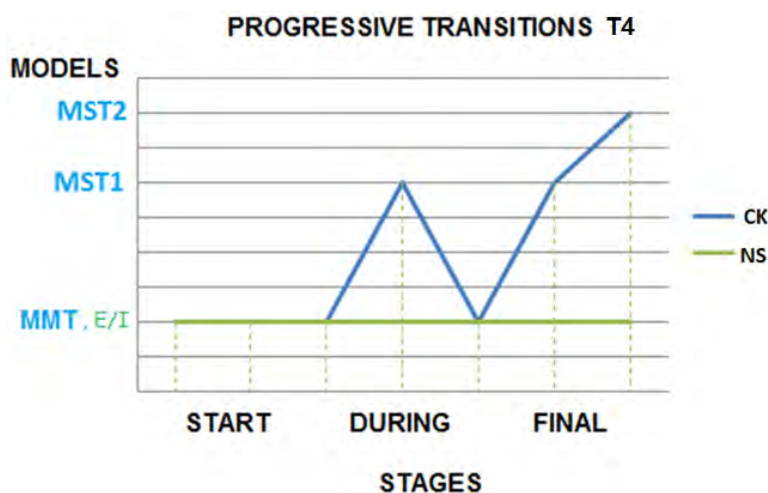
The use of the macroscopic model (MMT) decreases during the course, which was used by only three teachers, however, but during the preparation of the teaching plan there was an increase in the use of this model, nine teachers have developed their plan only focusing on the macroscopic aspects of study of the rate of a chemical reaction (graphic 1).





**Graphics 1.** Progressive Transition teachers during the three stages of the course. Note: CK: chemical Kinetics.

Only three teachers included in their teaching plans, the transition state theory (MST2), however, addressing only the idea of forming the activated complex and not the breaking and formation of new chemical bonds (graphics 2,3,4) However, some teachers experienced a progressive transition by building teaching models based on the understanding of microscopic explanatory model of chemical reaction rate as well as on the understanding of the nature of science (graphic 5).



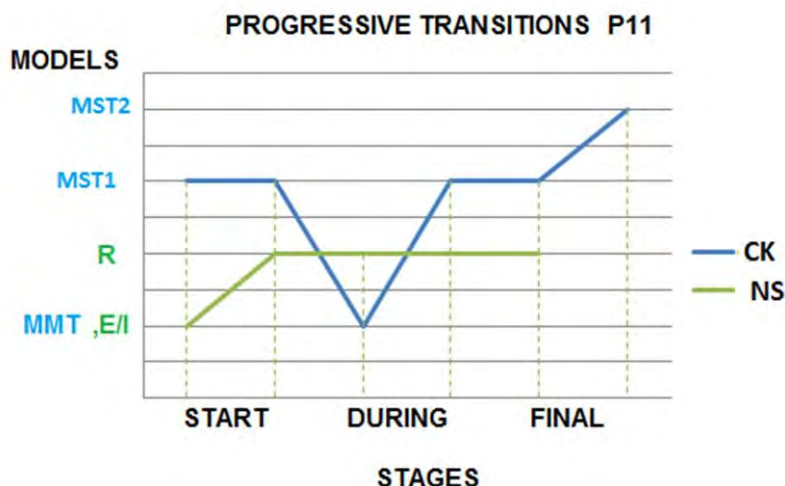
**Graphic 2.** Progressive Transition teacher T4 during the three stages of the course.  
Note: CK: chemical Kinetics; NS: Nature of science.

The teacher T4 (graphic 2) now includes in its explanations and its teaching plan, theoretical models to explain the factors that affect the speed of a chemical reaction, which was not originally used by her. Another change that occurred was related to strategies of instruction, started to include texts and experimental activities:

*"This course made me think to include more practical classes due to students being too "concrete", he needs to see. And as we have many of the students do not continue their studies in the field of chemistry, then only will this memory class "(T4)*

However, the teacher, the function of the experiment is consistent with the philosophical perspective empiricist / inductivist:

*"Development of practices: from the practice the student create the theory. Check the 'theory created' with the contents of the classic books. "(T4)*

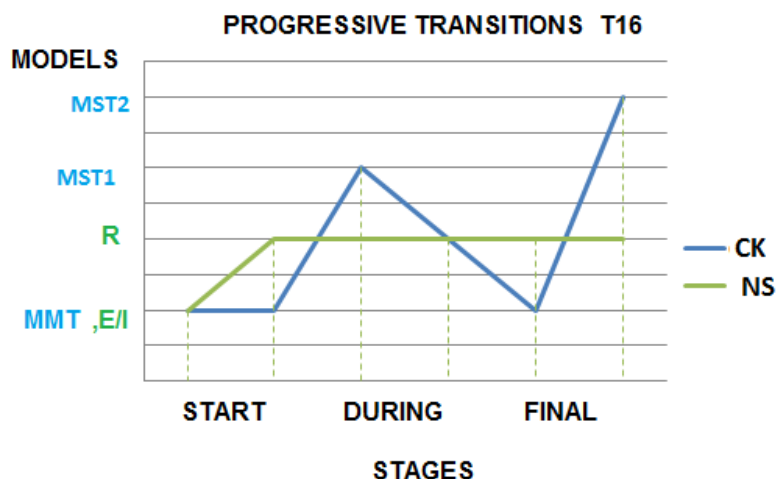


**Graphics 3.** Progressive Transition teacher T 11 during the three stages of the course.  
Note: CK: chemical Kinetics; NS: Nature of science.

In Figure 3 can be observed a gradual transition from teacher P11 in relation to their teaching models. It is observed that in relation to chemical kinetics, the teacher, although in two activities during the course did not use a theoretical model, in its teaching plan she chose to work with the ideas belonging to the models MST1 and MST2.

Concerning the nature of science, it is clear that his idea, which originally was consistent with the philosophical perspective empiricist / inductivist, moved to a rationalist perspective (idea of science as a human construction):

*"Knowing some of the historical processes that led to the knowledge we have today about the influence of concentration on the speed of reaction and know some scientists who contributed to this process."* (teaching plan, P11).



**Graphics 4.** Progressive Transition teacher T16 during the three stages of the course.  
Note: CK: chemical Kinetics; NS: Nature of science.

The content, which Professor T16, normally addressed in their classes, before their participation in the course was: factors that influence the rate of a chemical reaction where the chemical kinetics is applied to the student's life and what is its importance in the productive life therefore their initial model of teaching is based mainly on the macroscopic aspects of chemical kinetics (MMT).

In his final teaching plan, the teacher chooses to work with theoretical models to explain the speed and influence of the rate of a reaction (MST2):

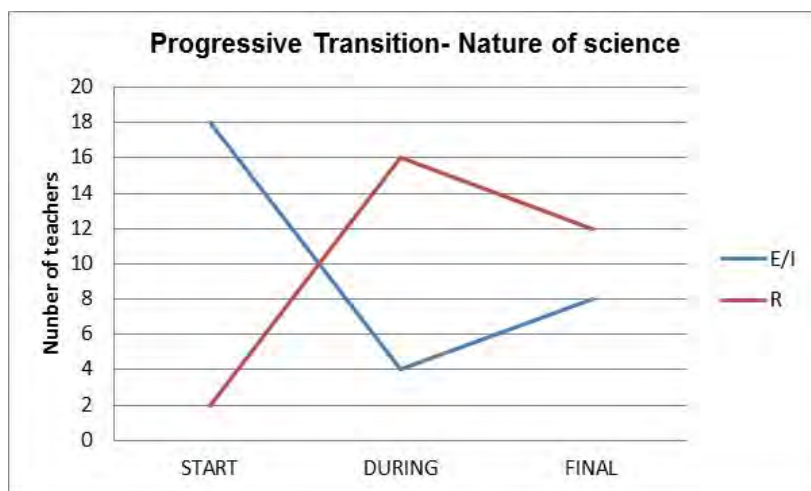
*"Resumption of chemical concepts covered in previous lessons about the influence of temperature and concentration on rate and retardation of the reactions, emphasizing the interaction and collision between the particles, the activation energy and activated complex in the process of chemical transformation" (4 th. Class teaching plan, P16).*

The aspects related to the nature of science, it can be seen in its plan in terms of teacher education, a view close to the rationalist philosophical perspective with regard to the idea that scientific knowledge is seen as a human construction:

"Reading and discussion with students about literature and history of the scientist who participated in the study of the evolution of Chemical Kinetics. Discussion with the mediation group and the teacher should lead the student to reflect on the question of the relationship between history of science and the contents of the kinetics developed in chemistry classes, so that the knowledge acquired to support students in their development and its action before the society in which they live (3rd class of the teaching plan, P16)

During the training course, there was a decrease in the number of teachers who had ideas related to the empiricist perspective / inductivist. This may be due to the discussions on this topic that occurred during the course of continuing education, as well as the manner in which the historical development of chemical kinetics was introduced to these professors. Always sought to emphasize the dynamic nature of science as well as the idea that knowledge is a human construction and that whenever they came looking for a solution to a problem found in time it was prepared. According to Niaz (2009), the discussion about the nature of science is complex and depends on the opportunities that teachers have to make reflections about different situations related to it.

*However, in the final phase of work, ie, in terms of education, one can identify eight teachers still held ideas related to this perspective (graphic 5).*



**Graphics 5.** Gradual transition of teachers in the three phases of research in relation to the following aspect of your teaching model: picture of the nature of science. Note: E/I: empiricist/inductivist. R: rationalist.

Regarding the practical aspects of this group of teachers, made these reflections, after the end of the course, about the importance of Historical approach in teaching chemical kinetics:

*"What is the vision of science, I want my students have and what better way to treat the history of chemistry classes of the day to day. That's because, with the course, this approach has been widely discussed, which led me to appreciate the importance of these topics in the teaching of chemistry "(T1)*

*"I thought about the necessity of the historical approach of chemical kinetics to give more meaning to the scientific content. Adequacy of experiment / simulation to "preview" of the influence of temperature, pressure and catalyst in a chemical processing speed "(T13)*

## Conclusions

It is observed from the analysis of the models of teacher education that the continuing education course facilitated, to varying degrees, a gradual transition to teaching models of chemical kinetics, since these, though still present difficulties to work with theoretical models (submicroscopic) have incorporated different strategies in their teaching of chemical kinetics, but also reversed the sequence of their teaching, based on students' initial ideas on this subject, which according to Kaya and Geban (2012) contributes to the improvement of teaching of chemical kinetics.

The activities performed during the course of continuing education also contributed to the construction of an image of science consistent with the contemporary rationalist perspective (Figure 5).

It is believed that work that teachers would have less difficulty in working together with these three aspects, chemical kinetics, History of chemistry and philosophy of science, if the course had a longer duration, less content and more opportunities for information and discussions, as pointed out by some teachers in the final evaluation.

However, monitoring of these teachers in relation to change in their teaching models showed the importance and necessity of the participation in continuing education courses, then, that context facilitates interaction, exchange of experiences among peers and contact with a range of knowledge that has been developed by the academy in the area of science education.

## Bibliography

- BEKTASLI, B. & CAKMAKCI, G. Consistency of students' ideas about the concept of rate across different contexts. *Education and Science*; 36(162), 273-287. 2011.
- CACHAPUZ, A.; PRAIA, J. Y JORGE, M.: *Ciência, Educação em Ciência e Ensino das Ciências*. Lisboa: Ministério da Educação, pp.59-94, 2002.
- CAKMAKCI, G., DONNELLY, J & LEACH, J.. A cross-sectional study of the understanding of the relationships between concentration and reaction rate among Turkish secondary and undergraduate students. In K. Boersma & O. de Jong & H. Eijkelhof & M. Goedhart (Eds.). *Research and the Quality of Science Education*. Dordrecht: Springer. pp. 483-497, 2005.
- GONZÁLEZ, A. M.; *Historia de la ciencia: una posible contribución a la formación de los profesores*. p. 345-360. La formación del profesorado de ciencias y matemáticas en España y Portugal. Lorenzo J. Blanco Nieto; Vicente Mellado Jiménez. (Coord.), 1994. Disponível em: <http://www1.unex.es/eweb/ljblanco/documentos/Blanco-Mellado-Final.pdf> (acessado em 21/12/2010)
- JUSTI, R.; *Models in the Teaching of Chemical Kinetics*. Tese de Doutorado. University of Reading; p. 1997.
- JUSTI, R; RUAS, R.M.; *Aprendizagem de química: reprodução de pedaços isolados de conhecimento? Química Nova na Escola*. Nº 5, p. 24-27, 1997.
- KAYA, Ebru e GEBAN, Ömer. *Facilitating Conceptual Change in Rate of Reaction Concepts Using Conceptual Change Oriented Instruction*. *Education and Science*, Vol. 37, No 163. p. 226-225. 2012.
- LAKATOS, I.; *História da ciência e suas reconstruções racionais*. Biblioteca de filosofia contemporânea. Edições 70. 1998.
- MARTORANO, A. A. S; *As concepções de ciência dos livros didáticos de química, dirigidos ao ensino médio, no tratamento da cinética química no período de 1929 a 2004*. Dissertação de mestrado. Universidade de São Paulo, 2007.
- NÍAZ, M.; *Progressive transitions in chemistry teachers' understanding of nature of science based on historical controversies*. *Science & Education*. (18). p.43-65, 2009.
- PRAIA, J.; CACHAPUZ, A. *Un análisis de las concepciones acerca de la naturaleza del conocimiento científico de los profesores portugueses de la enseñanza secundaria*. *Enseñanza de las Ciências*, vol 12, nº 3, p. 350-354. 1994.
- PORTO, P. A. *História e Filosofia da Ciência no Ensino de Química: Em busca dos objetivos educacionais da atualidade*. *Ensino de química em foco*. Editora Unijuí, p.160-180, 2010.
- POZO, J. I.; CRESPO, M. A. G.; *Aprendizagem e o ensino de ciências. Do conhecimento cotidiano ao conhecimento científico*. Editora Artmed. 5ª. ed., p. 46-76, 2009.
- vAN DRIEL, Jan H.; *Students' corpuscular conceptions in the context of chemical equilibrium and chemical kinetics*. *Chemistry Education: Research and Practice in Europe*. Vol. 3, No. 2, p. 201-213, 2002.

## Influence of e-Homework Use on Student Success in General Chemistry

Alice F. DUTTON<sup>1</sup>, M. Ryan PRNKA<sup>2</sup>, Joshua BELLAND<sup>3</sup>, and Diana MASON<sup>4</sup>

<sup>1</sup> Alice F. Dutton, Graduate Student; University of North Texas 1155 Union Circle #305070 Denton, TX 76203-5017 USA alicedutton@googlemail.com

<sup>2</sup> M. Ryan Prnka, Chemistry and Physics Instructor; Eagle River High School of Anchorage School, District 8701 Yosemite Drive, Eagle River, Alaska 99577 USA prnka\_matthew@asdk12.org

<sup>3</sup> Joshua Belland, Chemistry Teacher; Haltom High School, 5501 North Haltom Road, Haltom City, TX 76137 USA joshua.belland@birdvilleschools.net

<sup>4</sup> PhD Associate Professor of Chemistry; University of North Texas 1155 Union Circle #305070 Denton, TX 76203-5017 USA E.mail: dmason@unt.edu- Voice: 940-565-2491- FAX: 940-565-4318

### Abstract

*Web-based homework systems are becoming more common in general chemistry as instructors face ever-increasing enrollment and students wanting immediate feedback. Chemistry instructors consider completion of homework integral to students' success in chemistry, yet only a few studies have compared the use of Web-based systems to the traditional paper-and-pencil homework. This study compares the traditional homework system (Fall 2004, Spring 2005, and Fall 2011) to six different Web-based systems: Assessment and LEarning in Knowledge Spaces (ALEKS) Spring 2009 and Fall 2009; Catalyst (WileyPLUS) Spring 2008; MasteringChemistry (MC) Fall 2007; Online Web-based Learning (OWL) Fall 2005, Fall 2006, Spring 2006, and OWLBook (OWLbk) Spring 2012; Sapling Learning (Sapling) Fall 2010, Spring 2011, SmartWork (SW) Fall 2008. Data from 14 semester classes over eight years consisting of diagnostic pre/post tests, number of successful and unsuccessful students, final semester grades, and student opinion on the use of e-homework systems are analyzed. Results indicate that students are savvy when evaluating the self-efficacy of using e-homework and instructors should carefully consider options when selecting e-homework systems.*

**Keywords:** general chemistry, online learning, chemical education research

### Introduction

The appeal of online learning appears to be increasing but, *why?*, might be appropriate question to ask. The answer emanates from two perspectives: the professors' and the students'. The professor sees commercial online homework as a time saver and a way to get immediate feedback to students. The student sees ways to be able to do homework at their convenience, to obtain immediate feedback regardless of time, and a way to help with time management as well as cost savings when the typical textbook is not purchased. This study addresses the influence of the use of e-homework on student performance and how students perceive their experiences.

When one believes that he/she can succeed in a specific situation because of his/her ability, according to Bandura's social cognitive theory, self-efficacy is engaged. Online commercial homework systems are designed to emphasize content mastery and enhance students' self-efficacy through immediate response capabilities. The focus of this study is to document how students' opinions on the continued use of a particular homework system are viewed. In this study at the end of each semester, students who participated in the evaluation were asked to comment on whether or not the homework system that they had used for the past 4.5 months (one semester) should be continued the following semester. No point value was associated with the Yes/No response to the question nor did their responses influence the commercial system chosen for the following semester.

### Background

Current student circumstances and available technology no longer dictate that learning has to be face-to-face or at a set time. Creating an environment for students that is built on appropriate expectations can be

rewarding for them as well as create mutual respect for diverse learners. Simply due to the nature of a computer, all learning modalities are easily taken into consideration – tactile, active learning techniques, auditory and visual stimuli are available to the user. Some of the hallmarks of online learning are the ability to provide timely feedback and encouragement along with increasing the necessary time-on-task needed to improve student success.

Online learning creates an environment where students are required to actively participate in an interactive environment that requires engagement with the subject matter and encourages more time-on-task. Through instantaneous feedback students are granted individualized instruction that is rarely possible in large-group lecture classes typical of many university-level general chemistry courses. The Unified Learning Model (ULM) [1] identifies three components that underlie student learning: (1) *prior knowledge*, the most predictive component of learning and the major contributor to determining student's success in academic courses; (2) *engagement* with the subject matter, which is very important to success because when attention is diverted away from necessary course material important information is missed limiting student success; and (3) *motivation*, the driving force behind how students attend to the subject matter at hand. These are also aspects of online learning and compliment the components of the seven principles of undergraduate education explained over 25 years ago with a single exception of how the contact between the professor and student(s) occurs [2].

Online homework is a way to meet the needs of students by providing immediate, on-demand feedback indirectly allowing professors time to work on areas of critical need for their classes. Web-based or online homework has been shown to increase the time-on-task outside of the classroom reinforcing what is learned in the classroom [3]. However, there have been no reported significant differences in classes that use online homework compared to paper-based homework (similar to this study), but notable differences between paper-based and online homework have been published.

Retention of information was found to be greater in those who completed online homework compared to those who did not [4, 5, 6]. Also reported was a similar outcome when a delayed post-test was administered to students a month following instruction [6]. Students who used online homework performed statistically significantly better than the students who did not. Immediate feedback to students about their correct or incorrect choices has been proven greatly effective. Numerous studies have shown that immediate feedback boosts the confidence of students [5-11]. Epstein, Epstein, and Brosvic provided evidence that immediate feedback on academic testing increased retention and confidence levels of students so much that on a final exam those who had previously been provided with immediate feedback were two times more likely to answer correctly than those who had experienced delayed feedback [12]. Another study showed that there was a direct relationship of homework scores to exam scores. The students who scored consistently high on the homework scored higher on the exams than those whose scores were consistently lower [13]. Cuadros, Yaron and Leinhardt researched different aspects of course instruction that can influence learning and final course achievement. These researchers found that homework assignments that are context-rich, content-oriented and centered on course objectives help students improve their exam scores. The effects of homework were not immediate, but after feedback the students performed better on the exams [14]. Collard, Girardot and Deutsch demonstrated that pre-lecture preparation through online quizzes and assignments helped students perform in the class by increasing preparation and time-on-task [15].

Richards-Babb and Jackson reported that female students attributed successes to their dedication and hard work, while male students attributed successes to an innate ability. The introduction of online homework into the classroom led both male and female students to greater success. In this study female students' confidence improved as they learned by working problems correctly and male students were afforded a situation to develop better study habits. Online homework helped to close the achievement gaps between male and female students and develop both groups into more confident and better learners [6].

Freshmen students have many challenges to face as they enter college and have to become proficient in many areas seemingly all at once. The failure of many freshman students comes from their inability to become proficient at time management, planned study time, a heavier reading load, no reminders of tests

and homework, balancing work and play, and having to seek out help on their own [8]. De Vega and McAnally-Salas demonstrated how online homework helped give students a better grasp on learning their skills the first year in college. The students were able to be supported in their study habits and scheduling of time to work on chemistry. These students received feedback immediately enabling them to know if they needed to contact their professor for more help or not. They were given individualized help and prompts to help increase success. Benefits to the students are great and are even perceived by the students to be generally positive [8]. Benefits include better study habits, less cramming, better preparation for exams, consistent studying and more completing homework assignments [5]. Lower achieving students are more likely to stay in classes, as opposed to dropping or withdrawing, if they have the added support of online homework [6]. Cole and Todd also established that lower performing students were helped by online homework and their confidence in the class increased. This provided students the means by which to complete a course that they would have otherwise dropped or failed [7].

Arasasingham, Martorell and McIntire demonstrated that online homework is a good resource, if it is integrated seamlessly into the curriculum. It is important to choose a system that follows the textbook and the teacher's methods of instruction. Consistency between how the information is presented in class and in the homework and then once more on the exams is important [13].

### Online Systems Evaluated

There are different types of technology-integrated courses: traditional with 0% online instruction; Web-facilitated with 1-29% online instruction; blended/hybrid with 30-79% online instruction; and online courses with 80% or better and generally no face-to-face meetings [7]. These levels of integration are broad definitions. The use of online homework can be incorporated into any of these types of classes, outside of the traditional class. According to these definitions, the present study falls into the category of Web-facilitated instruction. Shibley et al. studied a hybrid course and the design and introduction of online homework and quizzes as support outside of the classroom. The grade point average (GPA) based on a 4-point scale (A = 4 points, B = 3 points, etc.). In this study a grade of A rose in both classes from 1.77 to 2.15 in the fall and 1.75 to 2.00 in the spring. The pass rates were compared to a traditional class that had in-class quizzes and paper-based homework; the pass rates in the fall term were 2.41 to 1 in the hybrid class and 1.61 to 1 in the traditional class. In the spring the pass rates were 2.08 to 1 in the hybrid and 1.51 to 1 in the traditional class. These numbers support that the online homework and quizzes added to the general ability of the students to pass and succeed in the general chemistry class [16].

In the current study attention was directed to what do students really think about the use of online homework. This study has been ongoing over the past eight years in a first-semester general chemistry class. Twelve semesters of data have been gathered from 1,939 students (56.4% male) who used various online homework systems. Some programs are available through textbook companies and have texts that are correlated to the homework. Other programs are independent and it is up to the professor to match homework with lecture content.

The commercial systems identified below were used in this study. The descriptions of the programs are mainly from the publishers' Websites and are listed in alphabetical order. In the corresponding author's opinion, none of the systems required a substantial learning curve before being implemented in classrooms. Class sizes ranged from approximately 60-390 members, enrollment dependent on room size. *ALEKS* (Assessment and LEarning in Knowledge Spaces) is a Web-based homework learning system. The system is advanced and uses adaptive questioning to identify strengths and determine what areas are in need of additional help. Students are given an assessment prior to content to allow the computer to assess the weak points. The program continues until the student has reached mastery of the designated topic. Students are exposed to questions that are not multiple-choice responses (i.e., open-ended) and require input with the use of tools to give a better sense of how the questions are worked out rather than just answers as feedback. At the end of each question the student is able to see a full explanation for the problem. The system reinforces past curriculum throughout the course to help with retention. The teacher is also able to align the program with a course syllabus to enable students to stay on track with the class [17].

*Catalyst* is an online course by the system WileyPlus. This system is designed to assess students' learning through problem solving. The program uses various types of questioning; concept mastery, drawing problems, reaction mechanisms and synthesis and has a test bank of questions. The system offers an integrated electronic text that will aid students as they work through the course [18].

*MasteringChemistry* is a Web-based learning system geared specifically for chemistry. The program offers tutorials and individualized coaching. The program is able to identify misconceptions and give students hints and feedback based on their answers. The program allows instructors to see student grades in order to identify the weak points of the class. The program allows instructors to include mathematics reviews to prepare students before attempting chemistry problems that require mathematics [19].

*Online Web Learning (OWL)* is the most widely used online chemistry program in the world, as claimed on the OWL Website. OWL was developed at the University of Massachusetts by chemistry teachers for chemistry teachers claiming to be focused on solving problems and correcting misconceptions that are prevalent in chemistry classes. This program offers tutoring and visualizations for deepening students' understanding. OWL gives students an opportunity to work at their own pace and reach mastery of each topic. There are mastery problems and end-of-chapter questions. The OWL system is compatible with many textbooks and questions directly from a text can be linked to the program. Answers to questions are given step-by-step to guide students through the process to reach the answer. The program offers videos, simulations and other resources to bridge classroom learning to knowledge. There are also teacher aids such as a grade book and student reports [20].

*OWLBook* is everything that is included with the OWL program but also consists of a totally integrated e-textbook with embedded questions relevant to the material being studied. This interactive, electronic textbook (e-book) can be personalized by the instructor to match the course syllabus thereby aligning the chapters with the sequence of the professor's course and excluding any content that will not be covered. The instructor also has the option to rewrite, delete, modify or add to the text. Videos and links are embedded to enhance the reading experience. This allows the students a text that goes hand-in-hand with the online program for homework and assignments [21].

*Sapling Learning* provides a general chemistry Web-based course. This system has easy to use toolboxes to minimize student frustration. It offers immediate feedback on each question, tutoring and a second chance, if incorrect, and a solution explanation at the end. There are a variety of questions as well as integrated simulations and visuals to engage the learner. The teacher has access to statistics and reports on student progress to help identify weak spots [22].

*SmartWork* is an intuitive tutorial and online homework system. It has a bank of questions that the teacher has full editorial control over and range from multiple choice, fill-in-the-blank, ranking, numeric- and short-answer questions. Students benefit from immediate feedback and are guided by tutorials with links to the textbook, an e-book, to reference after an incorrect answer. The system has an optional e-book that links to the system or it can be used with another text. As with most systems SmartWork offers a grade book and a way to identify weak content areas [23].

## Results

Students are savvy when evaluating the effectiveness of using e-homework systems. In this eight-year study, the seven homework systems mentioned above were used for one, two, or three semesters. ALEKS [17] (one fall and one spring semester), OWL [20] (two fall and one spring semester), Sapling [22] (one fall and one spring semester), and each of the remaining e-homework systems (*Catalyst* [18], *MasteringChemistry* [19], *OWLBook* [21], and *SmartWork* [22]) along with a semester where students solved problems from weekly e-quizzes generated by the fourth author were used for one semester. At the end of each semester, the students were asked one question: *Should \_\_\_\_\_ e-system be used the following semester?* Yes or No.

With nothing at stake to answer the question above one way or the other, the tabulated results were interesting. Table 1 data reveal how many students responded to the question and if they were affirmative or not. The most number of positive responses came from students who used OWL followed by those



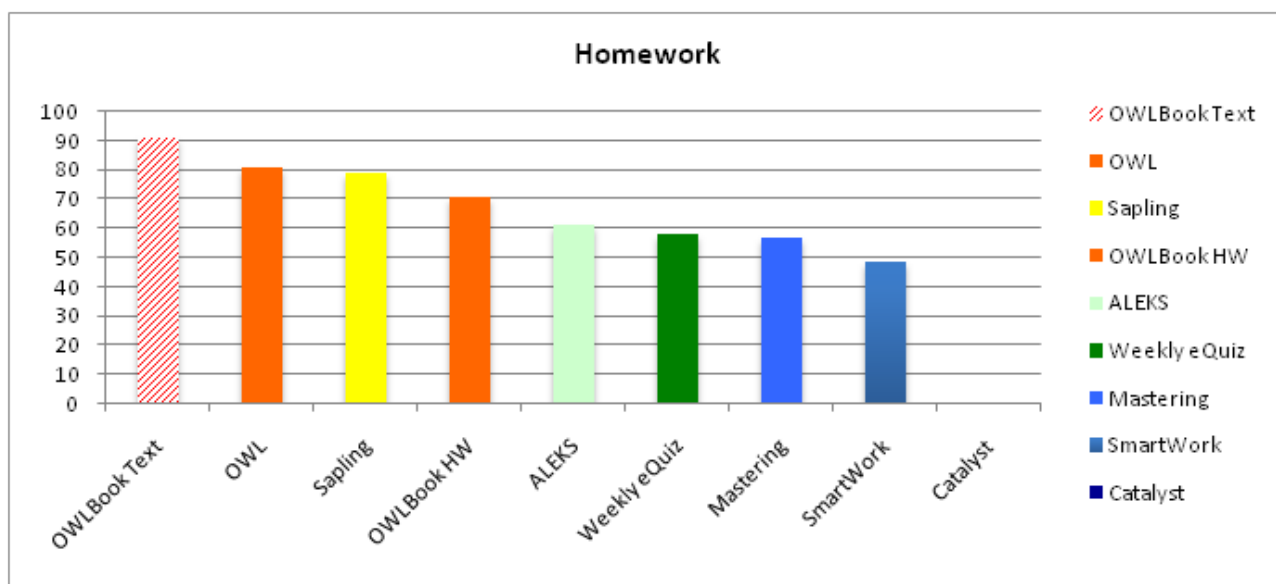
who used Sapling. An interesting aside about the use of a 100% online textbook, *OWLBook*, is that the majority of the students (see Figure 1) in the spring 2012 class responded that they would like to see the *OWLBook* [21] used again the following semester. Some of their comments included: "The e-book has freed up a lot of space (and reduced the weight of) my backpack" and "The ability to download individual chapter PDFs is a feature I have not seen with any other online course system or textbook."

**Table 1:** Students' Responses to Continuing the Use of Selected e-Homework Systems

% of course	16.6% ALEKS (2 Classes)	13.5% Catalyst (1 Class)	14.6% MC (1 Class)	14.7% OWL (3 Classes)	26.9% OWLbk (1 Class)	15.7% Sapling (2 Classes)	14.3% SW (1 Class)	21.9% Wkly eQ (1 Class)	16.5% Totals (12 Classes)
Enrolled –	365 –	144 –	71 –	290 –	287 –	418 –	66 –	139 –	1780 –
Withdrawals	50 –	21 –	8 –	38 –	33 –	54 –	15 –	11 –	230 –
– # Exempt (%)	13 – (3.6%)	1 – (0.7%)	0 – (0.0%)	15 – (5.2%)	25 – (8.7%)	19 – (4.5%)	1 – (1.5%)	8 – (6.7%)	82 – (4.6%)
Exempt* – no shows (% Absent)	47 (14.9%)	5 (4.1%)	0 (0%)	31 (12.3%)	23 (9.1%)	49 (13.5%)	8 (15.7%)	18 (14.1%)	181 (11.7%)
Eligible (%)	255 (69.9%)	117 (81.4%)	63 (88.7%)	206 (71.0%)	206 (71.8%)	296 (70.8%)	42 (63.6%)	102 (73.4)	1287 (72.3%)
Voted (%)	218 (85.4%)	NR	44 (69.8%)	78 (37.9%)	202 (98.1%)	289 (97.6%)	37 (88.1%)	100 (98.0%)	968 (75.2%)
Yes (%)	133 (61.0%)		25 (56.8%)	63 (80.8%)	145** (70.4%)	228 (78.9%)	18 (48.6%)	58 (58.0%)	670 (69.2%)
No (%)	85 (39.0%)		19 (43.2%)	15 (19.2%)	57 (29.6%)	61 (21.1%)	19 (51.4%)	42 (42.0%)	298 (30.8%)

\*For Comparison: Percentage (%) of No e-Homework Classes Exempt: 6/161 = 3.7%

\*\*OWLBook text: 184/202 = 91.1% were positive about continuing the use the OWLBook even though only 70.4% wanted to do the OWL homework.



**Figure 1** Rank order of the most to least popular e-homework systems as determined from students' vote on the question of whether said system should or should not be used the following semester. (The class that used Catalyst was not asked to respond to whether or not the use of Catalyst should be continued. The OWL products (orange) were purposely clustered even though Sapling (yellow) is technically between OWL and *OWLBook* HW. Due to the uniqueness of the 100% online *OWLBook* e-text (hashed orange) students were also asked to vote on its continuation of which over 90% voted to continue.)

Of the 11 classes asked the question (note that the students who used Catalyst<sup>18</sup> were not asked due to discontinued use at the professor's discretion), there were 1,287 students eligible to vote (72.3% of the population less the withdrawals and those who were exempt from the final exam due to superior grades over the entire semester). Of those eligible to vote, 968 (75.2%) voted and of this subpopulation, 69.2% reported that the continued use of an e-homework system was agreeable. It is also interesting to note that the students who had performed at a less than successful level were just as positive about continuation as

those who were considered successful students. Specifically, the OWL [20] system (80.8%) performed at a very high level as did the students who used the Sapling Learning [22] system (78.9%). Also interesting, is that the *OWLBook* [21] e-textbook excelled in the eyes of the students (i.e., over 91% of the students were favorable of the continuation of the *OWLBook* [21], even though the use of the accompanying homework was lower than hoped). In the *OWLBook* [21] data collected for the OWL [20] system homework from and separated from the embedded questions, which were found within the text and considerably more difficult than the typical mastery homework problems. The typical homework problems were received very positively (like the use of the OWL [20] system), but when the responses to the continued use of the embedded questions were added to the total the appreciation fell to 70.4%.

## Conclusions

The OWL products [20, 21] performed very well in this study as did the performance of the Sapling Learning [22] system (see Figure 1). Even though you can take this on the surface that maybe the students liked the OWL [20, 21] and Sapling [22] systems the best because they were perceived to be easier, but there is no evidence of this. However, in a larger study with the same 1,939 students, these two e-homework systems performed superior to all the other e-systems including a "control" semester when only weekly instructor-generated online quizzes were required of the students and two semesters where traditional paper-and-pencil homework was assigned.

In general the students who participated in this study were average freshman and sophomore students who were taking these general chemistry classes to fulfill requirements for a major (mostly in the biological sciences) leading towards bachelors of arts degrees in science or engineering. The key to success is always engaging the students so that they chose to participate. As in other reported studies, some students simply do not avail themselves of the opportunities afforded them [4]. However, for those that chose to participate, the majority considered the continued use of an e-homework system to be of value to the next general chemistry class. When their self-efficacy is impacted (either positively or negatively) students know. As each commercially available homework system improves over time, the more pervasive e-learning will become. The time is now, if you chose to participate, the students do!

## Acknowledgements

Appreciation is extended to all the students at the University of North Texas (UNT) who participated in this IRB-approved research as part of the funded UNT N-Gen Project for course improvement and the generous cooperation of all the commercial publishers (ALEKS, Cengage, Norton, Pearson, Sapling, and Wiley) that volunteered to be part of this study.

## List of References

1. D. F. Shell, D. W. Brooks, G. Trainin, K. M. Wilson, D. F. Kauffman, L. M. Herr The Unified Learning Model: How motivational cognitive, and neurobiological sciences inform the best teaching practices (Vol. 1). New York, NY: Springer Science+Business Media, 2010.
2. A. W. Chickering, Z. F. Gamson. *Am. Assoc. Higher Educ., Bull.*, 1987, 39, 3
3. M. Mendicino, L. Razzaq, N. T. Heffernan. *J. Res. Tech. Educ.*, 2009, 41, 331
4. B. Botch, R. Day, W. Vining, B. Stewart, K. Rath, K., Peterfreund, A., Hart, D. J. *Chem. Educ.*, 2007, 84, 547
5. M. Richards-Babb, J. Drelick, Z. Henry, J. Robertson-Honecker. *J. Coll. Sci. Teach.*, 2011, 40, 81
6. M. Richards-Babb, J. Jackson. *Chem. Educ. Res. and Prac.*, 2011, 12, 409
7. R. S. Cole, J. B. Todd. *J. Chem. Educ.*, 2003, 80, 1338
8. C. A. De Vega, L. McAnally-Salas. *US-China Educ. Rev.*, 2011, 1, 10
9. B. Freasier, G. Collins, P. Newitt. (2003). *J. Chem. Educ.*, 2003, 80(11), 1344
10. J. Goodwin, B. Gilbert. *J. Chem. Educ.*, 2001, 78, 490
11. M. Oliver-Hoyo. (2001). *J. Chem. Educ.*, 2001, 78, 1425
12. M. L. Epstein, B. B. Epstein, G. M. Brosvic. *Psych. Rep.*, 2001, 88, 889
13. R. D. Arasasingham, I. Martorell, T. M. McIntire. *J. Coll. Sci. Teach.*, 2011, 40(6), 70
14. J. Cuadros, G. Leinhardt, D. Yaron. *J. Chem. Educ.*, 2007, 84, 1047
15. D. Collard, S. Girardot, H. Deutsch. *J. Chem. Educ.*, 2002, 79, 520
16. I. Shibley, K. Amaral, J. Shank, L. Shibley. *J. Coll. Sci. Teach.*, 2011, 40, 80
17. Assessment and Learning in Knowledge Spaces : ALEKS. [http://www.aleks.com/about\\_aleks](http://www.aleks.com/about_aleks). Accessed 15 Aug 2012

18. Catalyst : WileyPLUS course. <https://www.wileyplus.com/WileyCDA/Section/CATALYST-for-General-Chemistry-Online-Mastery-Learning-System-for-Chemistry.id-402836.html>. Accessed 15 Aug 2012
19. MasteringChemistry : Pearson. <http://masteringchemistry.com/site/product/for-instructors.html>. Accessed 15 Aug 2012
20. Online Web-based Learning : OWL. <http://www.cengage.com/owl/index.html>. Accessed 15 Aug 2012
21. OWLBook. <http://www.youtube.com/watch?v=SblZHPC4CZA>. Accessed 15 Aug 2012
22. SaplingLearning. <https://www.saplinglearning.com>. Accessed 15 Aug 2012
23. SmartWork : W. W. Norton. <http://www.wwnorton.com/college/chemistry/gilbert2/smartwork.asp>. Accessed 15 Aug 2012

## Green Lights that Engage Chemistry Students

Anna GEORGE<sup>1</sup>, Carla SMITH<sup>2</sup>, G. Robert SHELTON<sup>3</sup>, Diana MASON<sup>4</sup>

<sup>1</sup> University of North Texas 1155 Union Circle #305070 Denton, TX 76203-5017 USA  
annarayb@aol.com

<sup>2</sup> School Counselor, Austin Peay State University P.O. Box 4547 Clarksville, TN 37044 USA

<sup>3</sup> Department of Chemistry Austin Peay State University P.O. Box 4547 Clarksville, TN 37044 USA  
sheltong@apsu.edu

<sup>4</sup> University of North Texas 1155 Union Circle #305070 Denton, TX 76203-5017 USA  
dmason@unt.edu Voice: 940-565-2491 FAX: 940-565-4318

### Abstract

*Prior knowledge, engagement, and attending to the task at hand are the required components of learning. Chemical demonstrations within the classroom can make a difference as to whether students pay attention, learn and retain the material, and sustain interest in the topic or not. As educators in trying economic times, the cost of demonstrations can be prohibitive. Chemical demonstrations allow for students to have the opportunity to see chemistry in action and pique their interest such that they want to know more. However, the consumable nature of chemistry experiments and demonstrations can result in these experiences being cost prohibitive and missed opportunities to inspire the next generation of chemists. With a little creativity and planning costs can be overcome. Several chemistry demonstrations exist that use inexpensive or reusable materials, allowing teachers to bring chemistry alive in the classroom. Our chemical demonstration program highlights concepts covered in beginning chemistry and illustrates different low-cost alternatives to engage your students in deeper learning.*

**Keywords:** Pre-college level, chemical demonstrations, low-cost chemistry teaching

### Introduction

Most classroom demonstrations focus on activities that support the concepts associated with the physical and chemistry properties of matter, interactions of atoms, and chemical-bond energy changes. Performing classroom demonstrations will introduce science concepts to students that relate the real world to classroom content and will also provide foundational information necessary to future studies in chemistry. The chemical demonstrations presented below are guaranteed to engage your students, and with a little creativity, have minimal expense when spread over several years. Of course, always be aware of potential danger and adhere to the accepted guidelines for classroom demonstrations (see Appendix A).

### Baby Thermite Reaction

The baby thermite reaction (figure 1) requires two rusted ball bearings and a piece of aluminum foil. It is preferable to find two of the same size that fit comfortably in your hands. Wrap one of the iron balls with aluminum foil and strike one against the other. If the proper amount of energy is used, many sparks will be made. The reaction between the aluminum and iron(II) oxide, results in the production of a small amount of iron, aluminum oxide, and energy (both in the form of sound and light). The discussion that accompanies this demonstration can include uses of the thermite reaction in underwater welding or repairing railroad ties on site as well as in the form of a thermite bomb for the purpose of destroying a metal file cabinet containing important papers quickly when a military installment needs to “bug out”. Additionally this demonstration can be used to illustrate that molecules need to interact with the proper orientation and energy of activation in order for the reaction to proceed [1].

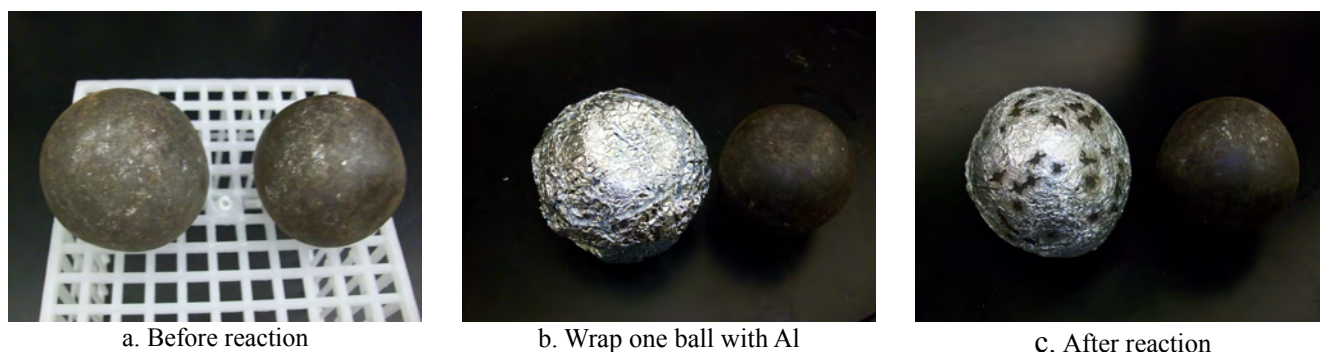


Figure 1 Stages for the Baby Thermite Reaction

### Electric Pickle

The Electric Pickle demonstration is useful in the discussions of electrolytic solutions, flame tests, and food chemistry. This demonstration requires a ring stand, clamp, pickle, and a "suicide cord" made from an electrical cord with the plug and a power switch intact and the other ends connected to non-galvanized iron nails with electrical tape and insulated with wooden blocks. Secure the pickle horizontally onto the ring stand using the clamp. Insert each nail into opposite ends of the pickle. Once the pickle has been set up and nobody is touching the pickle, plug in the cord. As the electric current passes through the pickle, the distinct yellow color associated with the sodium flame test will be seen along with water vapor escaping. The only material that will need to be replaced from one demonstration to the next is the pickle [2].

The electrode set-up for "suicide" cord can be see in Figure 2.

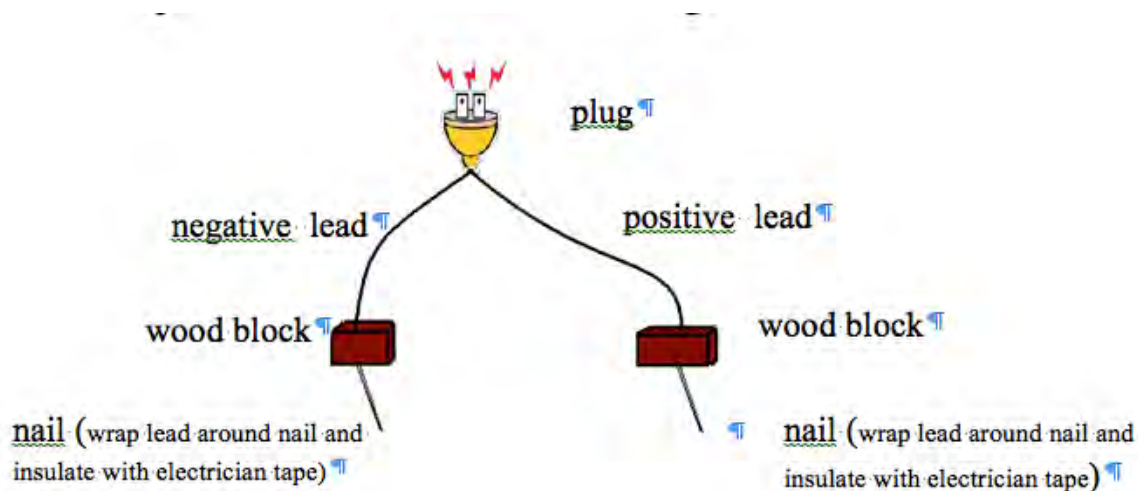


Figure 2 Suicide cord for the Electric Pickle demonstration (Nails should not be galvanized.)

### Mean Green Foam Machine (Elephant's Toothpaste)

Regular liquid dishwashing soap, 30% hydrogen peroxide (obtained from a beauty supply store as hair bleach), and a catalyst, potassium iodide or yeast can be used in a large cylinder (2000 mL or greater) to demonstrate the effect of a catalyst and the decomposition of hydrogen peroxide into water and oxygen gas. Hydrogen peroxide is a strong oxidizing agent; contact with skin should be avoided. Pour about 100 mL of the hydrogen peroxide and 50 mL liquid dish soap into the large cylinder. Allow the students to see that these liquids mix, but alone do not initiate a reaction. Discuss the ways to speed up reactions and the purpose of a catalyst. Add a few drops of food coloring along the inside of the cylinder for color effect [3] of the commercial "striped" toothpaste for children. Add about five grams dry yeast (or a catalyst such as potassium iodide) to the sample and watch as the decomposition of the hydrogen peroxide produces

bubbles in the dish soap and begins to foam out of the cylinder [4]. The classic glowing splint test can be performed to test for the identity of the gas contained in the bubbles. The glowing splint should show a flame when the splint is inserted into the bubbles, indicating the presence of oxygen gas production [3]. Also, as an addition to the classic demonstration (see Figure 3), varying concentrations (3%, 15%, and 30%) of hydrogen peroxide can be used to stimulate the discussion about concentration and rate of reaction.



**Figure 3** Preparation of Mean Green Foam Machine (left) and after products (right)

### **Peanut Races**

This activity requires a large amount of Styrofoam<sup>®</sup> packing peanuts used to package items for shipping and two (or more) large beakers (e.g., 1000 mL beaker) with acetone that is available for purchase at a grocery store as nail polish remover. Set up the beakers with about 20 mL of acetone in one of the beakers and 20 mL of water in the other beaker. Request two groups of two student volunteers (one to stuff in the peanuts and the other to swirl the beaker). Challenge the volunteers (with goggles donned) to race to fill their respective beakers with packing peanuts. The students will be surprised to find that the packing peanuts "dissolve" in the acetone—actually only the air is removed and two phases remain. This activity is useful in the discussion of physical (like dissolves like) versus chemical changes and identification of when chemical change occurs. The group who used water as the solvent saw no dissolution and therefore filled their beaker first, or won the race!

### **Water Demonstrations**

Water (dihydrogen monoxide (DHMO), hydrogen hydroxide) is ubiquitous and generally inexpensive, and exhibits many unusual properties. Several simple, engaging classroom demonstrations will be presented illustrating the physical and chemical properties of DHMO.

### **Density of Liquids**

This activity requires the construction of a density box made from Plexiglas<sup>®</sup>, poly(methyl 2-methylpropenoate), that can be reused over several years, hot and cold water, and food coloring. The box should be constructed out of clear Plexiglas<sup>®</sup> such that water is unable to leak out of the divided two compartments. A density box of this type is available commercially through scientific supply companies such as Flinn Scientific [5]. A removable divider should be constructed such that the water from one side is not able to mix with the water from the other side until the divider is slid out from the top (the use of petroleum jelly like Vaseline<sup>®</sup> or stopcock grease is advised). Use food coloring to distinguish between the hot (e.g., red) and cold (e.g., blue) water. Remove the barrier quickly and allow the two sections of water to mix. Initially, the hot and cold water will form two distinct layers that will be seen as a result of the different colors. As the temperatures reach equilibrium the colors of the water will blend together. This is a great opportunity for students to see the relationship of temperature and density with materials that are either reusable or inexpensive [6].

### Contaminated Water

An easy demonstration to discuss the importance of laboratory safety in the classroom can be done through a simple demonstration in which a small amount of lighter fluid is poured into a beaker such that the students do not notice the presence of a substance in the bottom of the beaker. Once the students have arrived in class, fill the "empty" beaker from a sink in the laboratory. Ask how many of the students would drink the water from the beaker and discuss the reasons behind their choices. Then, after the discussion is complete light a match and light the lighter fluid that is now floating on top of the water from the sink. The lighter fluid, which is non-polar and less dense than the water, should immediately ignite. The flame will continue until all of the lighter fluid is consumed. Once the flame has gone out you can revisit the earlier discussion to see if any of the students have changed their minds!

### Burning Money

Another simple demonstration illustrating the high specific heat of water is usually referred to as Burning Money that is simple to perform. Simply take an example of a dollar bill from the USA and dunk it held by tongs into a beaker that contains a mixture of about 50:50, water:ethanol (you can use 70% isopropanol with a little water added). Simply bring the wetted bill out of the solution and light it on fire—alcohol burns and water absorbs the heat keeping the paper from reaching its flash point (normal cellulose-based paper according to the title of Ray Bradbury's book (*Fahrenheit 451*, 1953) burns at 451 °F or about 233 °C—a great time to introduce the integration the study of chemistry and literature).

### Collapsing Can

The Collapsing Can is always a crowd pleaser and an excellent opportunity to discuss the behavior of gases. Heat an empty soda can with 10 mL of water until you see steam exiting the hole. Have a cooled water bath next to you. Take the can off the heat source with tongs, turn the can upside down, place it into the water bath, and let nature happen: when the steam condenses a partial vacuum is created and atmospheric pressure (now greater than the pressure inside the can) crushes the can.

### Jug of Fire (Whoosh Bottle)

One of the most common demonstrations of combustion in the introductory chemistry classroom is the Jug of Fire or Whoosh Bottle. Obtain a 5-gallon (20-L) water carboy and add about 20 mL of 70% isopropanol to the empty jug (95% ethanol can also be used). Cork jug and let vaporize or swirl the alcohol around the jug until it has vaporized. Drain any excess alcohol that remains in the liquid state—let the audience see that the carboy is "empty" by shaking out all excess in front of them. With an extended lit candle attached to a meter stick or Texas Match (a long Piezo lighter), insert flame into jug and watch the production of carbon dioxide, water, and a lot of energy from alcohol, oxygen, and the energy of activation. When the products have cool after about 30 s, the water produced can be drained from the carboy. Class discussion should be directed towards topics of exothermic vs. endothermic reactions, reactants and products of a combustion reaction, and the danger associated with gasoline (petrol) fumes. This reaction can be repeated but usually not immediately afterwards because of the products of water and carbon dioxide remaining in the carboy. When the reaction products are replaced by the regular atmospheric gases, this reaction can be repeated. Always check the carboy for any cracks before performing this demonstration.

### Conclusion

Creativity, imagination, and resourcefulness of chemistry teachers are the only factors that impede the availability of chemistry projects in the classroom. With a little ingenuity and determination, all science classrooms can reap the benefits of demonstrations being made available in the classroom on any type of budget!

See Appendix A for suggested safety guidelines required for all classroom demonstrations.

## References

1. Flinn Scientific, Inc. Smashing Thermit Reaction. ChemFax!, <http://www.flinnsci.com/Documents/demoPDFs/Chemistry/CF10503.pdf> (accessed 19 August 2012)
2. J. R. Appling, F. J. Yonke, R. A. Edgington, S. Jacobs, J Chem Ed, 1993, 70, 250
3. Flinn Scientific, Inc. Old Foamey: A Classic Demonstration of a Catalyst. ChemFax!, <http://www.flinnsci.com/documents/demopdfs/chemistry/cf0398.00.pdf> (accessed 19 August 2012)
4. C. A. Trujillo, J Chem Ed, 2005, 82, 855
5. Flinn Scientific, Inc. Density Box Demonstration, <http://www.flinnsci.com/store/Scripts/prodView.asp?idproduct=15070&noList=1> (accessed 19 August 2012)
6. D. A. Katz, Chymist.com, <http://www.chymist.com/hot%20and%20cold.pdf> (accessed 19 August 2012)

## Appendix A

### Safety Guidelines

1. GOGGLES MUST BE WORN AT ALL TIMES.
2. Individuals participating in demonstrations must be dressed appropriately. Appropriate clothing includes: closed toe shoes and long pants. It is also suggested that participants have on a lab coat for additional protection.
3. It is suggested that latex gloves be worn when handling strong oxidizers. (e.g., sulfuric acid, 30% hydrogen peroxide, and potassium chlorate).
4. Gloves (e.g., heavy duty work gloves or Zetex™ gloves) **MUST** be worn when handling dry ice or liquid nitrogen.
5. A fire extinguisher **MUST** be readily available throughout demonstrations containing potential fire hazards in case of fire.
6. The audience should be directed to use “elephant ears” (cupping their ears with their hands) for demonstrations containing loud noises to deflect intense noises from their ears without potential damage of their eardrums. The exhibitor should don ear protection during the demonstration.
7. The audience should be made aware of all exits from the demonstration chamber with the intent of allowing them to exit safely upon the event of an unforeseen major accident.
8. In the event of a chemical spill in one of the following scenarios, the following should be adhered to
  - a. Spill on an individual – Rinse the affected area with excessive amount of water.
  - b. Acid spill – Use sodium bicarbonate to neutralize the acid and then clean the spill up using copious amounts of water.



## From "ANIMAL" electricity to "METALLIC" electricity and the beginning of electrochemistry: The didactical view

Abdeljalil MÉTIOUI\*, Ahmed LEGROURI\*\*, Abdelkarim OUARDAOUI\*\*

\* *Département de Didactique, University du Québec à Montréal  
Case postal 8888, succursale Centre-ville, Montréal (Québec) H3C 3P8 Canada  
metioui.abdeljalil@uqam.ca*

\*\* *School of Science & Engineering, Al Akhawayn University in Ifrane,  
P.O. Box 1778 Ifrane, Morocco  
legrouri@gmail.com - A.Ouardaoui@aui.ma*

### Abstract

*From high school to University, students have always faced problems understanding the functioning of an electrochemical cell. In this article we will show that many of these encountered difficulties have been identified by scientists during the development of electrochemistry. Therefore, we will demonstrate how Volta, who rejected the idea of "animal" electricity as was illustrated by Galvani, postulated the existence of "metallic" electricity. Meanwhile, there was the emergence of a new theory, among others, initiated, by Faraday: The electrochemistry. Its development raised several controversial discussions among researchers and several conceptual difficulties will have been overcome as well.*

**Keywords:** History, Electrochemical cell, Students difficulties

### 1. Problematic

The study of "conceptions" by middle, high school and first year University students shows that there are some conceptual difficulties with regard to the basic concepts in chemistry [1, 2, 3, 4]. For example, study led by Bouraoui and Chastrette [2], on the conception on conduction in electrochemical cell for pupils (16-17 years) and for the second year French and Tunisian students (chemistry, physics, chemistry and ,biochemistry) shows that the majority of them have difficulties assimilating the qualitative aspects of electrochemical processes. One can for example mention difficulties in understanding that a battery works by displacing ions from one electrode to the other and not by electrons' transfer within the solution. Similarly, Laugier and Dumon [3] identified the nature of the difficulties that pupils of Middle school (15-16years) encounter with regard to the important concept of "elements" in chemistry: Three categories of barriers were identified: perceptive, mechanistic and realistic.

To help students from different levels overcome these conceptual difficulties, many educationalists suggested the introduction of the history of chemistry in the curriculum. According to Niaz [5] this would allow learners to know the construction style of scientific knowledge and the rules governing the operation of the scientific community. They would therefore be able to "see" chemistry right at its very beginnings: modest, tentative and full of errors, instead of disclosing it as accomplished and impressive, as mentioned in most textbooks. It is important to note that the study of erroneous theories developed in the course of history would allow the understanding of the phenomenon of persistence of the "naïve" conceptions by students of different levels despite the formal education [6].

This article, in the same line, aims at presenting a historical overview on the manufacturing of the electrochemical cell and the different interpretations as postulated by Galvani, Volta, and Faraday, amongst others. It elucidates also a feature of good scientists in general and good chemists in particular, with regards to their talent of excellent observer along with their critical thinking to the smallest detail.

### 2. Historical Overview

We can certainly, and without any doubt, describe the invention of the electric battery by the physician

Volta as revolutionary. This is a technical object capable of producing "electrical charges" continuously. It is worth mentioning in this regard, that we could, before its discovery, obtain "electric charges" by friction and store these charges in a bottle called "Leyden jar", from the name of the Dutch university where it was invented. The invention of this bottle, the ancestor of today's condensers was undoubtedly an important discovery, even if its use showed two major difficulties. On one hand, we were unable to store large amounts of charges and, on the other hand, one always has to apply the necessary friction in a moisture free environment.

However, how did Volta manage to make such a discovery that no researcher before him could realize? Without any doubt: an undeniable talent. In this paper we will present some answers to this question, in a synthetic way, by specifying certain factors that have enabled Volta to achieve such breakthrough. In the meantime, we will see that despite an erroneous interpretation of Volta on the operation of his battery, he still made one of the inventions that were responsible for important advances in physics and chemistry, and more particularly the genesis of electrochemistry which will be the central part of this article.

### **2.1 Galvani (1737-1798): "animal" electricity**

If the famous physician and anatomist Galvani had not observed the contraction of a frog muscle in his laboratory, the physicist Volta would probably not have invented the electric battery. Indeed, it is Galvani who has attributed the electrical phenomena to animal tissues by dissecting a frog leg. One of his assistants noticed that the legs, attached to an iron gate with brass clasps, contracted by contact with a scalpel. According to many historians, it would be the wife of Galvani that would have pointed out that the muscles always contracted close to an "electrostatic" apparatus [7]. Following this observation, Galvani made several experiments, among others, which consisted of conveying the discharge of the Leyden jar in frog legs and was able to observe their contractions. This led him to express that frog leg contained "animal" electricity. Thus, he inferred the presence of "animal" electricity in animals as an electrical unbalance between nerves and muscles. Note that at that time it was known that some animals such as the torpedo were capable of producing small amounts of electrical "charges" when their muscle is in motion. In addition the study shows that the biological aspect of "electricity" was very popular and it was also known that electrifying people by electrostatic machines was used for amusement.

### **2.2 Volta (1745-1827): "metallic" electricity**

The publication of Galvani's work on electrical forces in the muscle movement aroused great enthusiasm among some physiologists, causing at the same time some reluctance among physicist, especially Volta who has been having an excellent reputation as a talented experimentalist who, in 1782, had manufactured an instrument for detecting and measuring atmospheric electricity at ground level: the condenser based electrometer. Therefore, Volta managed to charge the Leyden jar thanks to a metal plate charged by induction using pre-electrified resin disc. It was an apparatus much less bulky than the friction machine that was used by the German von Guericke and much more powerful than the frequently used friction glass tube. He had also built a device to measure volume changes of a gaseous mixture during a chemical reaction: the eudiometer that allowed the burning of gas mixtures in an airtight container where a spark could be induced. This will be of great use for the chemist Gay-Lussac, amongst others, for analyzing the composition of the atmosphere. Volta worked with Voltaire, de Saussure, Laplace and Lavoisier, and was an adjunct member of the Royal Society of London.

This man, who was famous and renowned physicist, ardently opposed the existence of "animal" electricity. Worth mentioning, however, that at first, he thought that the electrical effects that appeared within organs were associated with the "animal electricity". But he changed his point of view by observing the effects despite the absence of an organ and had confirmed that, in the case of the frog leg, it was the two metals applied against the wet muscles of the frog that produced a "metallic" electricity rather than an "animal" one. The contraction of frog's leg observed by Galvani was possible only because there was a closed circuit in which the electrical charges could move. This circuit was formed by the iron grating, the frogs' legs and the hook of copper. Galvani could not explain the reaction mechanism under-

lying the observed phenomenon and was simply able to speculate the existence of "animal" electricity. We have seen that it is Volta who had questioned the existence of the manifestation of the animal type electricity by postulating the existence of "metallic" electricity since we can produce the same phenomenon by gathering several copper and zinc discs separated by pieces of cardboard soaked in salt water and stacked one above the other. Even if Volta could not explain the reaction mechanism underlying the operation of the battery, its discovery was a blow to the work in physiology, by Galvani, amongst others, who simply abandoned his career after the ruling of the Royal Society of London in 1800 in favor of Volta's thesis. However, even if Volta was unaware of the nature of the "current" produced by his cell, his invention will bring a revolution in the field of chemistry. These upheavals began when we realized we could break down substances that were thought unbreakable, as in the case of water, by a process of analysis called electrolysis. Thus, one could decompose the solutions by the passage of the voltaic electricity of unknown origin and very high voltages are needed to break the chemical affinity. For example, the English chemist Davy (1778-1829) managed by electrolysis of caustic soda and fused potash to the discovery of new metals, namely potassium and sodium. To achieve such a progress, he used a powerful battery made from 2000 copper plates and 2000 zinc plates that were immersed in diluted acid. The use of these "giant" batteries required regular cleaning of metals that would oxidize. It is important to note that the oxidation of metals in the stack was considered by many physicists as a mere parasite that was in no way connected to the mechanism of the chemical reaction related to the operation of the battery. In the extracted paragraph below, Blondel [8] summarizes the advanced explanations given by scientists about this important issue of the oxidation of plates:

*“This plates’ oxidization, which required regular and tedious cleanings, is important for the chemists that, as opposed to Volta, saw in it the origin of electric fluid movement. Davy has even related the quantity of the oxidized metal within the battery to the amount of electrolyzed solution. However, many physicists, such as the French scientist Biot, who developed the theory of Volta while taking only into account the electric tension between coupled metals, considered this oxidization as a simple parasitic phenomenon, just like rubbings in mechanics. Nevertheless, almost all agreed to compare the battery to a series of Leyde bottles that auto-recharges themselves and "discharges" when one joins their extremities through a metallic conductor.”*

### **2.3 Faraday (1782-1867): electrochemistry**

The discovery of new metals by Davy is certainly an important breakthrough which earned him a prize from Napoleon. However, regarding the occurrence of chemicals around the electrodes immersed in the solution, he advanced an erroneous explanation, arguing that only the molecules around the electrodes decomposed and he provided the following reasoning: “The positive electrode attracts the negative portion of a molecule and allows therefore the positive part to recombine with the negative one of a neighboring molecule. Successive recompositions take then place throughout a chain from one electrode to the other” [8]. Another chemist, Berzelius, goes beyond Davy stating that all chemical reactions could be explained by the association of elements of opposite charges [8].

These arguments, based on the attraction and the electrostatic repulsion, do not take into account the environment in which electrical "charges" move and it is Faraday, who began his scientific career as an assistant in Davy's laboratory, who proposed an explanation at odds with those of Davy and Berzelius: “It is Faraday who, about 1834, after his discovery of electromagnetic induction, had shown that during the electrolyze, the driving force is not at the poles but within the body under decomposition. This is not a force at a distance around the poles, but an action on the whole solution which drives the components in the opposite directions” [8].

Faraday conducted several experiments that led him to establish quantitative laws in the electrolysis. Some of his accomplishment is summarized below [9]:

*“Faraday established a relationship between the degree of chemical affinity of two elements and the ease by which they travel to the opposite poles in the electrolytic decomposition, and he introduced the terms "anode" and "cathode". It is still Faraday who developed a device to measure the amount*

*of electricity, which he called a "voltmeter". He performed electrolysis experiments of water and of several hydroacid and elaborate his first law: "The weight of a substance deposited or liberated on an electrode during electrolysis is proportional to the total quantity of electric charge that passed through the solution. Later, after passing the same amount of electrical charge in several liquids such as water, tin chloride, lead borate and hydrochloric acid, Faraday postulated the concept of "electrochemical equivalent" corresponding to the weight of various decomposed bodies to the same amount of electricity. This is how electrochemistry has emerged".*

Faraday also explained the electrolysis with reference to ions even if he ignored, at that time, today's atomistic conception of matter. According to Faraday, the transfer of electricity in the electrolyte is carried out via molecular fragments of dissolved particles which he called ions.

## Conclusion

In conclusion, the credit of a battery making, although without understanding its mechanism, is attributed to Volta. Indeed, he has associated the observed phenomenon to the existence of a form of "metallic" electricity, while denying the existence of "animal" electricity, as postulated by Galvani. Despite the lack of coherent explanations on the principle of operation of Volta's electrical battery, we can confirm that Faraday was able to advance the answers that will play an important role in the development of electrochemistry. In terms of education in high school as well as at the University, the introduction of such important historical elements of the invention of the electric battery of Volta in teaching physics and chemistry would show that his unexpected discovery led researchers, through their hard work, reveal some properties of matter that were previously unknown. Also, they could learn that despite its experimental simplicity, Volta's experiment raised pertinent questions and was behind several downstream proposals. They would also see that all experimenters would not necessarily make the same observations as they are closely associated with their own theoretical framework and background. These considerations could be considered as a concrete example of progression and of the interdependence of different disciplines in the construction and development of any science, with physics and chemistry being good examples.

## References

- [1] P. J. Garnett, D. F. Treagust. Conceptual difficulties experienced by senior high school students of electrochemistry: Electrochemical (Galvanic) and electrolytic cells, *Journal of Research in Science Teaching*, 1992, 29, 10, 1079-1099.
- [2] K. Bouraoui, M. Chastrette. Conceptions of French and Tunisian students on conduction in electrochemical cells. *Didaskalia*, 1999, 14, 39-60.
- [3] A. Laugier, A. Dumon. In search of the epistemological obstacles to the construction of the chemical element concept by the pupils of second. *Didaskalia*, 2003, 22, 69-97.
- [4] M-H. Chui. A national survey of students' conceptions in Chemistry in Taiwan, *Chemical Education International*, 2005, 6, 1, 1-8.
- [5] M. Niaz. How to facilitate students' conceptual Understanding of chemistry? - A history and Philosophy of science perspective. *Chemical Education International*, 2005, 6, 1, 1-5.
- [6] A. Tiberghien. Of the naive knowledge to the scientific knowledge. In M. Kail, M. Fayol (dir.). *The cognitive sciences and the school. The question of the trainings*, pp. 333-443. Presses Universitaires de France, Paris, 2003.
- [7] P. Devaux. *History of the electricity*. Collection Que sais-je? Presses Universitaires de France, France, 1954.
- [8] C. Blondel. Electricity and magnetism in the XIX<sup>e</sup> century. In J. Rosmorduc, (dir.): *History of the physics (Tome 1)*. Technique et Documentation – Lavoisier, pp. 185-215, Lavoisier – Tec & Doc, Paris, 1987.
- [9] B. Bensaude-Vincent, I. Stengers. *History of the chemistry*, La Découverte, Paris 1993.

## Use of the label of BOTTled Mineral Waters: A Way to Introduce the Properties of Electrolytic Solutions

Franco CALASCIBETTA<sup>1</sup>, Gabriele FAVERO<sup>2</sup>, Giuliano MORETTI<sup>1</sup>, Simone MORPURGO<sup>1</sup>

<sup>1</sup>Department of Chemistry, Sapienza University of Rome, <sup>2</sup>Department of Chemistry and Drug Technologies, Sapienza University of Rome, Piazzale Aldo Moro 5, 00185 Roma, Italy.  
giuliano.moretti@uniroma1.it ; Tel. +39-06-49913539; Fax +39-06-490324

### Abstract

*In previous contributions we showed how several subjects related to the chemistry of electrolytic solutions may be introduced in a General Chemistry course considering the analytical and physico-chemical data reported on the label of bottled mineral waters. This way is particularly interesting to our students because it considers the real solutions that make possible the maintenance of life on earth. Examples such as the principle of electroneutrality of electrolytic solutions, the relationship between the ratio  $[\text{HCO}_3^-]/[\text{CO}_2(\text{aq})]$  and the pH of the solution, the colligative properties (osmotic pressure and depression of the freezing point) and the concept of “water hardness” were considered. We suggested that it could also be possible to investigate the relationships between the nature and concentration of the ions and the electrical conductivity of the mineral waters. In this contribution we complete our approaches showing firstly how the principle of electroneutrality of the solutions can also be used to confirm that in mineral waters solutions silica is essentially present as  $\text{H}_4\text{SiO}_4$  (or as amorphous  $\text{SiO}_2$ ) species and secondly how the comparison between experimental and calculated electrical conductivity (at infinite dilution) of the mineral water solutions can be used at the General Chemistry level to introduce the concepts of ionic force and of non ideal behaviour of the solutions. This approach represents in our opinion both a direct way to introduce a difficult topic and a good introduction to the more advanced approaches to the study of electrolytic solutions presented at the more advanced Analytical and Physical Chemistry courses.*

**Keywords:** bottled mineral waters; physico-chemical data; principle of electroneutrality; electrical conductivity; calculated electrical conductivity (at infinite dilution); ionic force of the solution.

### Introduction

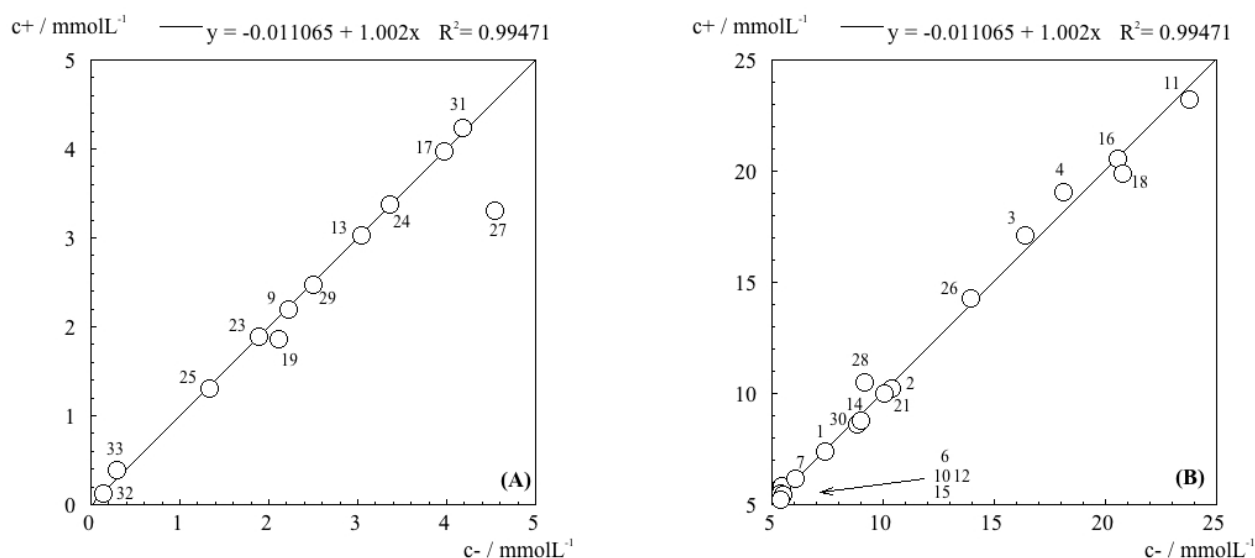
With the aim to contribute to the general discussion about the efficacy of new ideas and didactical experiences in the teaching of General Chemistry at the first-year undergraduate level, we present a way to introduce the fundamental subject of the electrolytic solutions that will be treated at the more advanced levels in the Analytical and Physical Chemistry courses. Previously [1-2] we considered bottled mineral waters, for which analytical and physico-chemical data are reported on their labels, and showed how several General Chemistry subjects may be introduced in a way that we believe much more interesting to our students. Examples such as the principle of electroneutrality of electrolytic solutions, the relationship between the ratio  $[\text{HCO}_3^-]/[\text{CO}_2(\text{aq})]$  and the pH of the solution, the colligative properties (osmotic pressure and depression of the freezing point) and the concept of “water hardness” were considered. (In Refs.[1-2] the analytical and physico-chemical data gathered from the labels of more than 25 bottled mineral waters were considered and reported in details.) We suggested that it could also be possible to investigate the relationships between the nature and concentration of the ions and the electrical conductivity of the mineral waters.

In this contribution we complete the previous approaches [1-2] showing i) how the principle of electroneutrality of the solutions can also be used to confirm that in these solution silica is essentially

present as  $\text{H}_4\text{SiO}_4$  (or as amorphous  $\text{SiO}_2$ ) species and ii) how the comparison between experimental and calculated electrical conductivity (at infinite dilution) of the mineral water solutions can be used to introduce the concepts of ionic force and of the non ideal behaviour of the solutions. At the General Chemistry level this approach represents, in our opinion, both an interesting and direct way to introduce difficult topics, and a good introduction to the more advanced approaches related to the behaviour of the electrolytic solutions presented later in the Analytical and Physical Chemistry courses. It may be of interest to recall that "Water in the environment" was one of the themes selected to celebrate the International Year of Chemistry 2011 to engage students, volunteers and the general public by designed activities and resources [3].

### Silica is present in the mineral waters as $\text{H}_4\text{SiO}_4$ ( or amorphous $\text{SiO}_2$ ) neutral species or as $\text{H}_3\text{SiO}_4^-$ or $\text{H}_2\text{SiO}_4^{2-}$ anionic species?

We ask our student to check the electroneutrality of the mineral water solutions starting from the qualitative and quantitative analysis of the ions obtained from their labels, assuming the hypothesis that all silica is present as neutral species. The result of this exercise is reported in **Fig.1** where, together with the bottled mineral waters considered in Refs.1 and 2, we added two new entries, n.32 (Lauretana-2006) and n.33 (Amorosa-2007), representative of mineral waters with the lowest amount of dissolved solutes, in particular 14 mg/L and 25 mg/L, respectively. The amount of dissolved solutes is obtained by water evaporation and a thermal treatment of the solid residue at  $180^\circ\text{C}$ . Note that each number in **Fig.1**, and in the other figures shown in this work, represents a bottled mineral water whose analytical and physico-chemical data are reported in Refs.[1-2].



**Fig.1** Check of the electroneutrality of the mineral waters solutions: (A) low ions concentration; (B) medium-high ions concentration. The concentration of the charges is calculated in  $\text{mmolL}^{-1}$  from the analytical data reported in  $\text{mgL}^{-1}$  taking into account the charge of the ions. Each number refers to a bottled mineral waters (see Refs.1-2 for details). The best straight line through the experimental points is  $y = -0.011065 + 1.002x$ , coefficient of determination  $R^2 = 0.99471$ .

The data reported in **Fig.1** demonstrate that in the mineral waters silica must be present in the neutral form  $\text{H}_4\text{SiO}_4$  (or as amorphous  $\text{SiO}_2$ ). The hypothesis according to which silica may be present as an anionic species ( $\text{H}_3\text{SiO}_4^-$ , or  $\text{H}_2\text{SiO}_4^{2-}$ ) cannot be true because it implies some deviation from the princi-

ple of electroneutrality. In fact if all silica were in the form  $\text{H}_3\text{SiO}_4^-$  the best straight line through the experimental points becomes  $y = -0.17516 + 0.96018x$ , coefficient of determination  $R^2 = 0.98928$ . On the other hand, if all silica were present the form  $\text{H}_2\text{SiO}_4^{2-}$  the parameters become even less favourable to the electroneutrality condition:  $y = -0.23982 + 0.90954x$ ,  $R^2 = 0.97175$ .

As recently recalled by White and Provios [4] the silica species present in the 5-8 pH range, typical of mineral waters [1-2], may only be soluble  $\text{H}_4\text{SiO}_4$  species or amorphous  $\text{SiO}_2$  species, the latter being present if silica concentration in aqueous solutions is higher than about  $10^{-3} \text{ mol kg}^{-1}$ . Monomeric and oligomeric charged silica species may be present only at pH higher than 9.

### Electrical conductivity of the mineral waters

The fundamental measurement used to study the motion of ions is that of the electrical resistance of the solution with the use of a conductivity cell and of alternating current (frequency of about 1 kHz) to avoid electrolysis and polarization of the solution in contact with the electrodes [5]. The electrical conductivity  $\kappa$ , is the inverse of resistivity and it is normally expressed in  $\text{S cm}^{-1}$  ( $\text{S} = \Omega^{-1}$ ). The conductivity of a solution depends on the number of ions present and on the temperature. In the case of a solution of only one electrolyte it is normal to introduce the molar conductivity  $\Lambda$ , which is defined as

$$\Lambda = \kappa 1000 / c_0 \quad (1)$$

where  $c_0$  is the molar concentration of the electrolyte. The molar conductivity is normally expressed in  $\text{S cm}^2 \text{ mol}^{-1}$ .

The conductivity  $\kappa$  of mineral waters solutions (generally measured at 18 or 20°C) is one of the physico-chemical properties always reported on their labels together with the analytical composition and the pH. Theoretically it is possible to calculate this quantity assuming an ideal behaviour of the solution, i.e. considering the solutes at infinite dilution so that each ion is free to move in the solution in response to the applied electric field independently from the presence of the other ions. Under this condition each ion can be characterized by its molar conductivity  $\lambda^0$ , which only depends on its chemical nature, the solvent and the temperature [5]. These data are in general reported for the temperature of 25°C [5,6] but can be easily reported at the experimental temperature by using Eq.(2) [2,5-6]

$$\lambda^0(t^\circ\text{C}) = \lambda^0(25^\circ\text{C}) [1 + 0.020(t - 25)] \quad (2)$$

The conductivity, at a given temperature, can be calculated by the following equation

$$\kappa = \sum_k \lambda_{+k}^0 c_{+k} + \sum_k \lambda_{-k}^0 c_{-k} \quad (3)$$

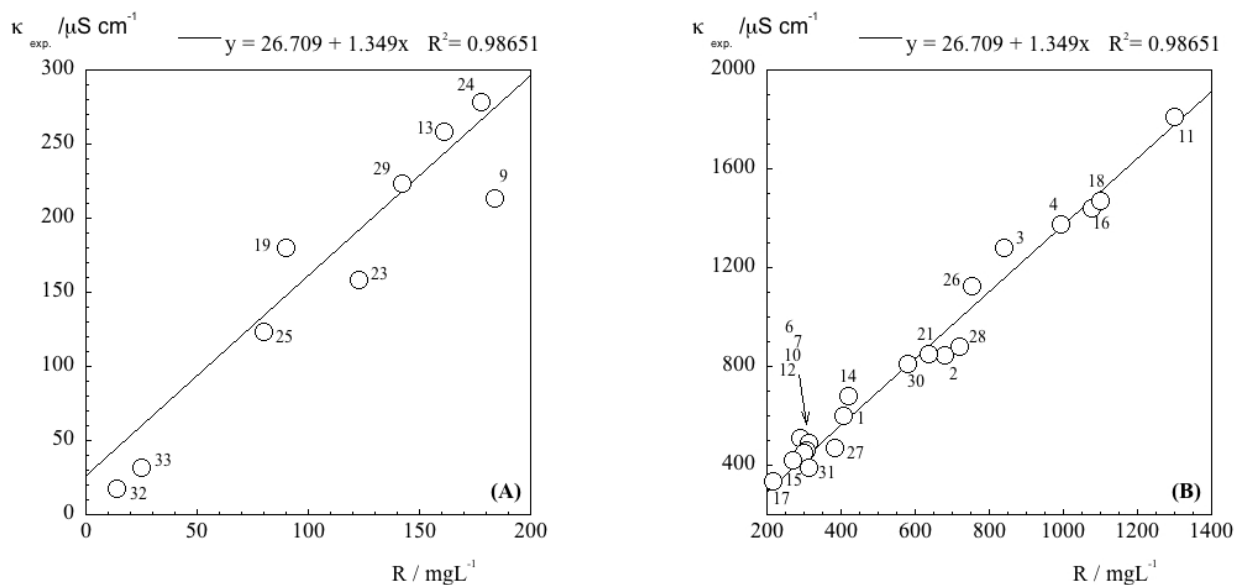
where the sums are taken over all the ions of a given charge and concentration.

Firstly it is useful to obtain the empirical relationship between the conductivity and the amount of dissolved solutes  $R$ , obtained by water evaporation after treatment of the solid at 180°C. This quantity may be used to group together the mineral waters according to the following values:  $R \leq 50 \text{ mgL}^{-1}$ ;  $50 \text{ mgL}^{-1} < R \leq 500 \text{ mgL}^{-1}$ ;  $500 \text{ mgL}^{-1} < R \leq 1500 \text{ mgL}^{-1}$  and  $R > 1500 \text{ mgL}^{-1}$ . In Fig.2 is shown the empirical relationship  $\kappa$  vs  $R$ . The best straight line through the experimental points is

$$\kappa \approx 26.71 + 1.349 R \quad (4)$$

Eq.(4) may be used to estimate one of the observables when we know the other one. Note, however, that

Eq.(4) cannot be applied with confidence to mineral waters with  $R < 50 \text{ mgL}^{-1}$  because at  $25^\circ\text{C}$  for  $R \rightarrow 0$ ,  $\kappa \rightarrow 0.058 \text{ }\mu\text{S cm}^{-1}$ , the specific conductivity of pure water [5].



**Fig.2** Relationship between the conductivity and the amount of dissolved solutes  $R$ , obtained by water evaporation and after treatment of the solid at  $180^\circ\text{C}$ : **(A)** mineral waters with low ions concentration; **(B)** mineral waters with medium-high ions concentration.

Each number refers to a bottled mineral waters (see Refs.1,2 for details).

It is easy to foresee that the difference between the experimental conductivity  $\kappa_{\text{exp.}}$  and the calculated conductivity  $\kappa_{\text{cal.}}$  should be related to the total concentration of the ions in solution because it must depends on ion-ion interactions.

The total electrolyte concentration in solution will affect also other important properties such the dissociation or the solubility of different salts.

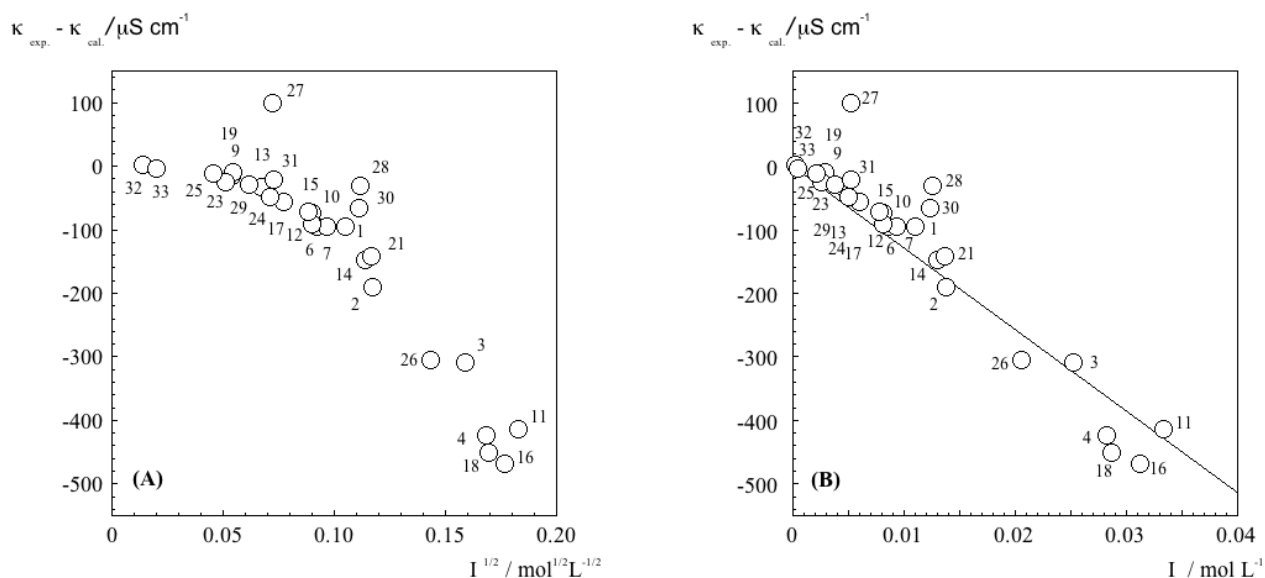
The ionic strength of a solution,  $I$ , is a measure of the concentration of the ions in that solution and may be used to take into account the deviation of the properties of electrolytic solutions from the ideal behaviour. The ionic strength is defined by the equation

$$I = (1/2) \sum_k c_{+k} (z_{+k})^2 + (1/2) \sum_k c_{-k} (z_{-k})^2 \quad (5)$$

where  $c$  is the molar concentration of ions ( $\text{molL}^{-1}$ ),  $z$  is the charge number of that ion, and the sum is taken over all ions in the solution. (The activity coefficients of ions, used in later Analytical and Physical Chemistry courses to calculate the activity of an ion in solution from its concentration, also depend on the ionic force of the solution and on their charge type rather than their specific identities.)

In **Fig.3** we explore the possible relationship between  $(\kappa_{\text{exp.}} - \kappa_{\text{cal.}})$  and the ionic force of the solution calculated according to Eq.(5) starting from the analytical data reported on the label of bottled mineral waters.





**Fig.3** Difference between experimental and calculated conductivity ( $\kappa_{\text{exp.}} - \kappa_{\text{cal.}}$ ) of mineral waters as a function of the ionic force of the solution  $I$ , calculated according to Eq.(5): **(A)** ( $\kappa_{\text{exp.}} - \kappa_{\text{cal.}}$ ) vs  $I^{1/2}$  and **(B)** ( $\kappa_{\text{exp.}} - \kappa_{\text{cal.}}$ ) vs  $I$ . The lines through the experimental points in part (B) of the figure is only a guide to the eye. Each number refers to a bottled mineral waters (see Refs.1-2 for details).

The quantitative formulation of the effects that influence the conductivity of the mineral water solutions is very difficult as we know that even the advanced Debye-Huckel-Onsager theory can only describe the conductivity of the simplest solutions containing only one electrolyte [5]. At the level of the General Chemistry our interest is to point out the necessity of introducing the simple concept of ionic force, which helps us to cope with the complexity of the real and very important aqueous solutions.

We know that when an electric field is applied to a solution of ions and all the ions drift in a certain direction, the ionic atmosphere around each ion is incompletely formed in front of the moving ion and is incompletely decayed behind of it. The centres of positive and negative charges no longer coincide and this leads to a reduction of the ions' mobility, the so called *relaxation effect*. Moreover, the presence of the ionic atmosphere influences the motion of the ions also by another effect, the enhanced viscous drag, also called the *electrophoretic effect*, associated to the movement of the ionic atmosphere in the opposite direction with respect to the central ion. Such an effect reduces the mobility of the ions and therefore the conductivity of the solutions.

From the graphs shown in **Fig.3** it is possible to see that the solution may be considered to have a quasi-ideal behaviour at low  $I$  values ( $I < 0.01 \text{ mol L}^{-1}$ ), whereas at higher  $I$  values the behaviour of the electrolytic solution is strongly non ideal. Moreover, a comparison between Fig. 3A and Fig. 3B may suggest that, for the very complex mineral waters solutions the conductivity can be described by the empirical equation:

$$(\kappa_{\text{exp.}} - \kappa_{\text{cal.}}) \approx -a I \quad (6)$$

which shows that the difference between  $\kappa_{\text{exp.}}$  and  $\kappa_{\text{cal.}}$  is linearly dependent on the ionic force of the solution.

## Conclusions

The analytical and physico-chemical data reported on the label of bottled mineral waters may be used by the students to learn many important properties of the electrolytic solutions. We point out that, even at the level of a General Chemistry course, it is very useful to introduce the concept of ionic force of an electrolytic solution. This simple concept helps us to cope with the complexity of these solutions and may serve as an introduction to the more advanced treatments to the theory of electrolytic solutions presented in later Analytical and Physical Chemistry courses.

## Riferimenti bibliografici

(Note that Refs.1 and 2 are available free of charge via the Internet at [http://www.soc.chim.it/it/riviste/chimica\\_nella\\_scuola](http://www.soc.chim.it/it/riviste/chimica_nella_scuola))

1. F. Calascibetta, G. Moretti, CnS La Chimica nella Scuola 2012, 34(1), 24
2. F. Calascibetta, G. Moretti, CnS La Chimica nella Scuola 2011, 33(5), 320
3. E. K. Jacobsen, J. Chem. Educ. 2011, 88, 530 (*JCE* Resources for chemistry and water: an update for the International Year of Chemistry. [www.chemistry2011.org](http://www.chemistry2011.org) accessed 30 July 2012.)
4. C. E. White, J. L. Provis, J. Phys. Chem. C 2012, 116,1619
5. K. J. Laidler, J. H. Meiser, Physical Chemistry, Houghton Mifflin Company, Boston 1999, 3rd edition, pp. 264-319 ( Cap.7 Solutions of electrolytes).
6. P. Vanysek, Handbook of Chemistry and Physics, D.R. Lide (Editor-in-Chief) 87<sup>th</sup> Edition, 2006-2007, pp. 5-76 e 5-77 (Ionic conductivity and diffusion at infinite dilution.)

# Microscale Experiments on Determining Densities of Ethanol-Water Mixtures<sup>1</sup>

Tetsuo NAKAGAWA

*Department of Biosphere Sciences, School of Human Sciences, Kobe College  
Okadayama, Nishinomiya, Hyogo 662-8505, Japan  
E-mail: nakagawa@mail.kobe-c.ac.jp*

## Abstract

*Although density is one of the most important properties in high school and university science, several difficulties often arise in measuring it. In this paper, a simple, easy, fast, inexpensive, and environmentally friendly teaching material is proposed on determining densities in high school or university. The densities of ethanol, water, and their mixtures (0.1-0.9 mass fraction of ethanol at intervals of 0.1) have been determined at room temperature and atmospheric pressure with the aid of microscale experiment procedure. An electronic balance and a 5-mL graduated cylinder have been used as apparatuses. Observed densities of these liquids and solutions are in agreement with reference data. In this procedure, the least amount of liquid samples is ca. 1.2 mL and it takes only ca. 2 minutes to determine the density of each sample. That is, both the amount of reagents and the experiment time are extremely reduced in comparison with the traditional experiment. Moreover, using our density data, molarities of ethanol and excess molar volumes in the ethanol-water mixtures are estimated over the whole concentration range, and they are both satisfactory. Therefore, it has been found that our methods of determining densities of ethanol, water, and their mixtures are useful and informative as teaching materials for high school and university science.*

**Keywords:** microscale experiment, density, ethanol-water mixture, molarity, excess molar volume

## 1. Introduction

Density is one of the most important physicochemical properties for students who are learning science in high school. The definition of density  $d$  is as follows:

$$d = m / V \quad (1)$$

where  $m$  is mass and  $V$  is volume.

Densities are usually measured using a pycnometer. However, the following difficulties arise: First, a pycnometer is very expensive. For example, the prices of 10, 25, 50, and 100 mL-pycnometers are ca. €14, 15, 17, and 20, respectively<sup>2</sup>. Secondly, it is fairly difficult for high school students to use a pycnometer. For a liquid sample, it is necessary to measure three masses of only a pycnometer ( $m_a$ ), of it filled with a sample ( $m_b$ ), and of it filled with water ( $m_c$ )<sup>3</sup>. For a solid sample, the procedure is more complicated: to measure four masses of only a pycnometer ( $m_a$ ), of it plus a sample ( $m_e$ ), of it plus a sample filled with water ( $m_f$ ), and of it filled with water ( $m_g$ )<sup>4</sup>. Thirdly, the density of a sample cannot be determined without the density of water, that is, if the exact volume of a pycnometer is not known, it should be estimated using the density of water. In this way, more simple procedure should be adopted in high school science.

In Japanese high school science textbooks, determining the density of a solid sample using a 100-mL graduated cylinder instead of a pycnometer is shown [1-3]. However, a large solid sample is required and in order to obtain the volume of a sample, the volume of water should be measured *twice*: before and after

1. Tetsuo Nakagawa, 22<sup>nd</sup> International Conference on Chemistry Education, Rome (ICCE), July 2012, p. 333

2. See Sansyo general catalogue, 2012-13, Japan, supposed 1 yuro corresponds to 105 yen.

3. Liquid density  $d_L$  is obtained as follows:  $d_L = (m_b - m_a)d_w / (m_c - m_a)$ , where  $d_w$  is the density of water.

4. Solid density  $d_S$  is obtained as follows:  $d_S = (m_e - m_a)d_w / \{(m_g - m_a) - (m_f - m_a)\}$ , where  $d_w$  is the density of water.

putting a sample into water. To solve these problems, we would like to propose the alternative method of determining densities of ethanol, water, and their mixtures with the aid of *microscale experiments*.

There are many advantages in *microscale experiments*: simple, easy, fast, inexpensive, and environmentally friendly. Textbooks concerning *microscale experiments* have been published [4-9], and we have already performed the *microscale experiments* such as decreases in volumes in forming alkanol-water mixtures [10-13].

Our *microscale method* has the following merits: First, instead of a solid sample, a liquid sample is used to save time (that is, the volume of a sample can be directly measured). Secondly, instead of a 100-mL graduated cylinder, a 5-mL one is used to reduce the amount of samples. Using our procedure, we will determine the density data of water, ethanol, and their mixtures, and compare our observed data with the reference [14]. Various concentration units such as mass fraction and molarity [15] and excess molar volumes [12] are taught in high school chemistry and university physical chemistry respectively. Therefore, we will estimate the molarities of ethanol and the excess molar volumes in ethanol-water mixtures over the whole concentration range using our observed density data.

## 2. Experiment

### *Materials (Reagents and Apparatuses)*

Ethanol (> 99.5 %) was purchased from Wako Pure Chemicals Industries, Ltd. and used without further purification. Distilled water was prepared using the ADVANTIC automatic water distillation apparatus RFD240NA. The nine ethanol-water mixtures in which the mass fraction of ethanol varied from 0.1 to 0.9 at 0.1 intervals were prepared.

An electronic balance ( $\pm 0.01$  g, METTLER TOLEDO, PL202-s) and a 5-mL graduated cylinder (SIBATA, JIS-class A) were used for measuring the mass and the volume of a sample respectively.

### *Procedure*

All experiments were carried out at room temperature and atmospheric pressure. Before performing experiments, a 5-mL graduated cylinder was rinsed with a liquid sample which density would be determined.

The determination of a sample density is as follows: First, the mass of an empty graduated cylinder was measured using an electronic balance ( $\pm 0.01$  g, METTLER TOLEDO, PL202-s). Secondly, a liquid sample in less than 5.0 mL was placed in a 5-mL graduated cylinder, and its volume  $V$  was measured. Indeed, the  $V$  values were varied from 1.2 to 4.9 mL. Thirdly, the mass of the sample plus a cylinder was measured, and the mass of sample  $m$  was obtained with subtracting the mass of the cylinder. And finally, the sample density  $d$  was determined using equation 1.

This procedure was repeated twenty times for each sample, and the average density and standard error were estimated. Mass values were plotted against volume ones, and the average density corresponding to the slope of a regression line was also estimated using the least square method.

### *Safety Precaution*

Ethanol is flammable and toxic. Safety goggles must be worn, and no open flames should be in the laboratory.

## 3. Theory and reduction

### *Conversion of mass fraction to molarity*

Mass fraction  $w_1$ <sup>5</sup> and molarity  $c_1$  are frequently used as concentration units for binary solutions. Their definitions are as follows:

5. Mass percent (mass %) means 100w1.

$$w_1 = m_1/(m_1 + m_2) = m_1/m \quad (2)$$

$$c_1 = n_1/V \quad (3)$$

where  $m$ ,  $n$ , and  $V$  are mass, amount of substance, and volume respectively. Suffixes 1 and 2 denote components 1 (ethanol) and 2 (water) respectively and no suffixes denote system (ethanol-water mixtures). The conversion equations have been already derived between  $w_1$  and  $c_1$  [15], and  $w_1$  can be converted to  $c_1$  as follows:

$$c_1 = w_1 m / (M_1 V) = w_1 d / M_1 \quad (4)$$

where  $M$  and  $d$  are molar mass and density respectively.

The  $c_1$  values were estimated over the whole concentration range using  $w_1$  and our observed  $d$  values in equation 4 at intervals of 0.1 of ethanol mass fraction.

### Excess molar volume

The excess molar volume  $V_m^E$ , which means the deviation from the ideal solution, is shown as [12]:

$$V_m^E = \{x_1 M_1 + (1 - x_1) M_2\} / d - \{x_1 M_1 / d_1 + (1 - x_1) M_2 / d_2\} \quad (5)$$

where  $x$ ,  $M$ , and  $d$  are mole fraction, molar mass, and density respectively. The definition of  $x$  is the following:

$$x_1 = n_1 / (n_1 + n_2) = n_1 / n \quad (6)$$

In equation 5,  $x$  is calculated as [15]:

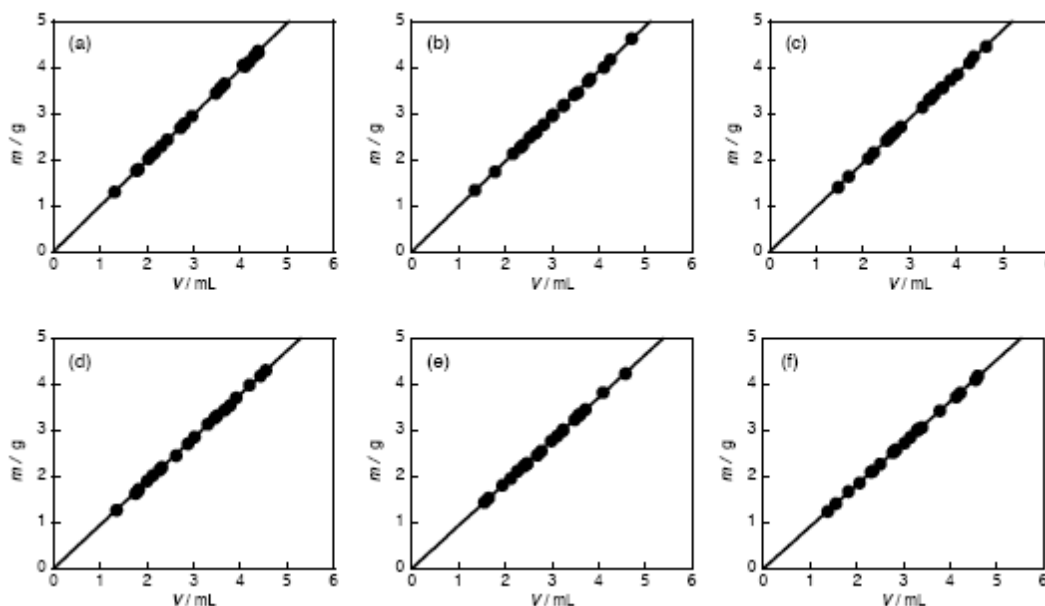
$$x_1 = w_1 M_2 / \{w_1 M_2 + (1 - w_1) M_1\} \quad (7)$$

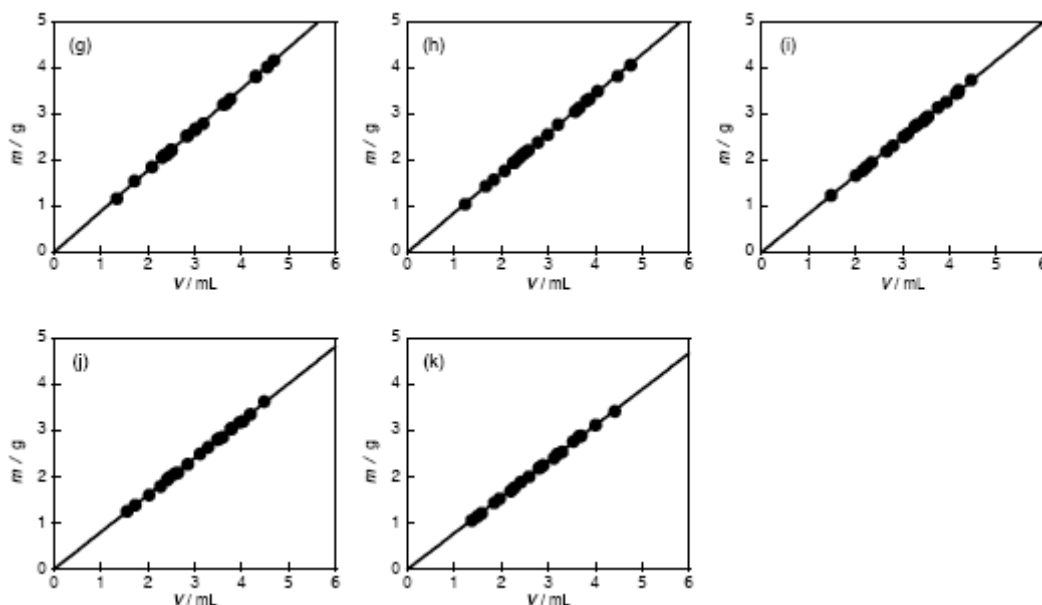
The  $V_m^E$  values were estimated over the whole concentration range using  $w_1$  and our observed  $d$  values in equations 5 and 7 at 0.1 intervals of ethanol mass fraction.

## 4. Results and discussion

### Observed densities using microscale methods

The averages of twenty densities for respective samples are successfully obtained because their standard errors are very small (0.001 g/mL), that is, the observed densities are reproducible.





**Figure 1** Relationship between the mass  $m$  and the volume  $V$  in pure water, pure ethanol, and the ethanol-water mixtures at room temperature (a) 0.0 (pure water), (b) 0.1, (c) 0.2, (d) 0.3, (e) 0.4, (f) 0.5, (g) 0.6, (h) 0.7, (i) 0.8, (j) 0.9, and (k) 1.0 (pure ethanol) mass fractions of ethanol

Figure 1 shows the relationship between mass and volume for respective samples. For all samples, the mass is proportional to the volume, namely, equation 1 strictly holds, and the slope decreases with increasing the concentration of ethanol. The slopes (that is, regression coefficients which corresponds to the average densities) are estimated using the least square method<sup>6</sup>. Observed densities are summarized in Table 1 with the reference data at 25°C [14].

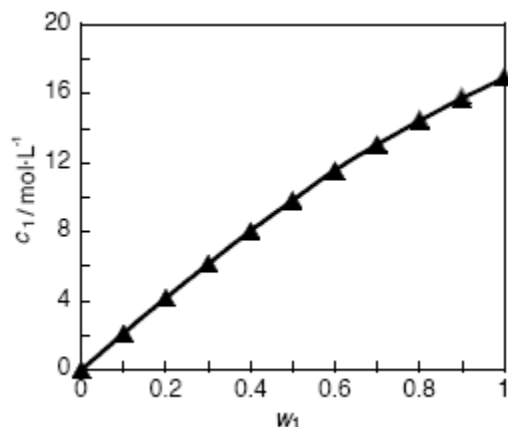
**Table 1.** Densities of Ethanol-Water Mixtures (in  $\text{g}\cdot\text{mL}^{-1}$ )

$w_1$	0.000	0.100	0.200	0.300	0.400	0.500
Observed1*	$0.991 \pm 0.001$	$0.978 \pm 0.001$	$0.962 \pm 0.001$	$0.943 \pm 0.001$	$0.927 \pm 0.001$	$0.906 \pm 0.001$
Observed2**	$0.990 \pm 0.001$	$0.978 \pm 0.001$	$0.962 \pm 0.001$	$0.944 \pm 0.001$	$0.927 \pm 0.001$	$0.905 \pm 0.001$
Ref. [14]***	0.99705	0.98040	0.96636	0.95064	0.93145	0.90982
$w_1$	0.600	0.700	0.800	0.900	1.000	
Observed1*	$0.888 \pm 0.001$	$0.859 \pm 0.001$	$0.832 \pm 0.001$	$0.805 \pm 0.001$	$0.779 \pm 0.001$	
Observed2**	$0.888 \pm 0.001$	$0.859 \pm 0.001$	$0.832 \pm 0.001$	$0.805 \pm 0.001$	$0.780 \pm 0.001$	
Ref. [14]***	0.88696	0.86337	0.83908	0.81360	0.78504	

In Table 1, the density decreases with increasing the concentration of ethanol. The observed densities are in agreement with the reference data within two significant figures. The density can be obtained with a few samples such as 1.2 mL, and the volume of a sample is reduced by less than 1/20 in comparison with the traditional experiment [1-3]. It takes only two minutes to carry out our *microscale experiments* in determining the density (i.e. the mass and volume) of every sample. These findings suggest that our procedure is useful in junior high school science class.

6. If the least square method is not taught in high school, let the students measure the slope of the  $m$ - $V$  line directly.

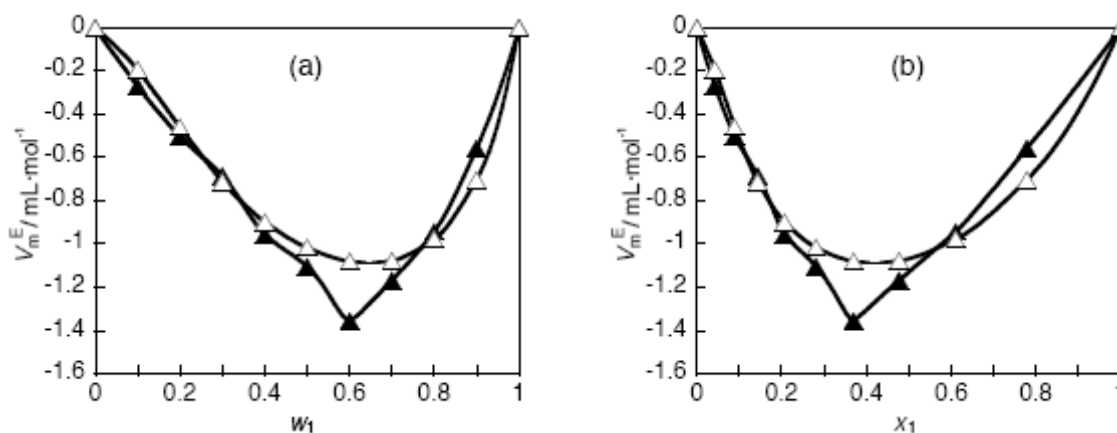
### Molarities



**Figure 2** Conversion of mass fraction of ethanol  $w_1$  to molarity  $c_1$

Figure 2 shows the molarity  $c_1$  of ethanol vs the mass fraction  $w_1$  of ethanol in ethanol-water mixtures. There is no proportional relation between  $c_1$  and  $w_1$ , and this means that the density of ethanol-water mixtures varies nonlinearly with changing  $w_1$  (See equation 4). The  $c_1$  values obtained using our density data ( $\blacktriangle$ ) are in good agreement with those using reference density values ( $\Delta$ ). Because both nearly superimpose each other, the symbol  $\Delta$  does not appear in Figure 2. This implies that our density data is very useful for estimating  $c_1$  of ethanol. Clearly, our procedure of estimating  $c_1$  can be used in high school chemistry lecture.

### Excess molar volumes



**Figure 3** Excess molar volumes  $V_m^E$  in the ethanol-water mixture  
(a)  $w_1$  dependence, (b)  $x_1$  dependence

Figure 3 reveals the mole fraction or mass fraction dependence on excess molar volumes  $V_m^E$  in ethanol-water mixtures. The  $V_m^E$  values are all negative and this fact means that the ethanol-water mixture is far from ideal, and that the volume contraction occurs in mixing both [10-13]. The  $V_m^E$  values obtained using our density data ( $\blacktriangle$ ) are in agreement with those using reference density values ( $\Delta$ ) except at 0.60 mass fraction (0.37 mole fraction) of ethanol. Because the  $V_m^E$  values are fairly smaller than molar volumes of

ethanol and water<sup>7</sup>, their slight errors may cause this inconsistency. The concentration dependence on  $\blacktriangle$  is similar to that on  $\Delta$ , and our density data is reasonable if the experimental accuracy is taken into account. Obviously, our procedure of estimating  $V_m^E$  is valid in university lectures such as physical chemistry, thermodynamics, or solution chemistry.

## 5. Conclusions

The densities of ethanol, water, and their mixtures have been determined at room temperature with the aid of *microscale experiments*. Observed densities of these solutions are in agreement with reference data within two significant figures. Densities can be determined with a few samples such as 1.2 mL. The volumes of samples are reduced by less than 1/5 in comparison with the traditional experiment. It takes only two minutes to carry out our *microscale experiments* in determining the density of every sample. Molarities of ethanol and excess molar volumes in ethanol-water mixtures are also estimated over the whole concentration range using our observed densities, and they are both satisfactory. Consequently, the validity of our methods has been confirmed.

## Acknowledgments

This work was supported by JSPS KAKENHI [a Grant-in-aid for Scientific Research (C) from the Japan Society for the Promotion of Science], Grant Number 20500748 and 24501072. And thank to Ms M. Shiiba for her helping us perform our microscale experiments, and to Professor T. Yoshikuni and Dr. K. Ohashi for their encouragements.

---

7. The molar volumes of ethanol and water at 25 °C are 18.07 and 40.75 mL·mol<sup>-1</sup> respectively [12].

## References

- [1] H. Yoshikawa et al., *Mirai he Hirogaru Saiensu 1* (Junior High School Science in Japan 1), Keirinkan, Tokyo 2012 (in Japanese)
- [2] A. Arima et al., *Rika no Sekai 1* (Junior High School Science in Japan 1), Dainippontoshu, Tokyo 2012 (in Japanese)
- [3] S. Okamura et al., *Atarashii Kagaku 1* (Junior High School Science in Japan 1), Tokyoshoseki, 2012 (in Japanese)
- [4] M. M. Singh, R. M. Pike, and Z. Szafran, *Microscale and Selected Macroscale Experiments for General and Advanced General Chemistry*, Wiley, New York 1995
- [5] J. Skinner, *Microscale Chemistry*, Royal Society of Chemistry, London 1997
- [6] K. L. Williamson, J. G. Little, *Microscale Experiments for General Chemistry*, Houghton Mifflin, Boston 1997
- [7] The Chemical Society of Japan (ed.), *Microscale Chemistry Experiments*, Tokyo 2003 (in Japanese)
- [8] C. B. Bishop, M. B. Bishop, and K. W. Whitten, *Standard and Microscale Experiments in General Chemistry*, Fifth Edition, Brook/Cole, Belmont 2004
- [9] H. Shibahara, Y. Sato, *Microscale Experiments*, Ohmsha, Tokyo 2011 (in Japanese)
- [10] T. Nakagawa, *Rika no Kyoiku* (Science Education in Japan), 2007, 56(8), 566 (in Japanese)
- [11] T. Nakagawa, 21<sup>st</sup> International Conference on Chemical Education, Taipei, August 2010, p. 79
- [12] T. Nakagawa, *Chemical Education and Sustainability in the Global Age* (Proceedings of 21st ICCE in Taipei), Springer, in press
- [13] T. Nakagawa, *The International Chemical Congress of Pacific Basin Societies (Pacifichem)*, Honolulu, December 2010, <http://www.pacifichem.org/> Accessed 10 December 2010
- [14] W. M. Haynes (ed.), *CRC Handbook of Chemistry and Physics*, 92<sup>nd</sup> ed., CRC Press, Boca Raton 2011
- [15] T. Nakagawa, *Educ. Chem.* 1998, 35(4), 108



## Doing Inquiry in Chemistry and Biology The Context's Influence on the Students' Cognitive Load

Andreas NEHRING<sup>1</sup>, Kathrin NOWAK<sup>2</sup>, Annette UPMEIER zu BELZEN<sup>2</sup>, Rüdiger TIEMANN<sup>1</sup>

<sup>1</sup>Humboldt-Universität zu Berlin, Institut für Chemie, Didaktik der Chemie - Brook-Taylor-Str. 2, 12489 Berlin

<sup>2</sup>Humboldt-Universität zu Berlin, Institut für Biologie, Fachdidaktik und Lehr-/Lernforschung Biologie,  
Invalidenstraße 42 10115 Berlin

E-mail: andreas.nehring@chemie.hu-berlin.de E-mail: ruediger.tiemann@chemie.hu-berlin.de

Telephone: +49-(0)30-2093 7109 Telefax: Fax: +49-(0)30- 2093 7482

### Abstract

*In this study we investigated the context's influence on the cognitive load of students working on chemistry and biology inquiry tasks. Based on a theoretical structure describing epistemological actions important for inquiry in science 90 inquiry tasks for chemistry and biology each were constructed and given to 15 years old students of Berlin schools (N=428). These tasks contained typical inquiry problems like the formulation of hypotheses, the planning of experiments and observations or the analysis of data derived from these types of investigation. With the help of a 6 item scale showing an excellent internal consistency the cognitive load was assessed after each of three inquiry methods: observing, experimenting and modelling. The analysis revealed significant differences for cognitive load scores between inquiry tasks for chemistry and for biology but no differences between the inquiry methods within these two science disciplines. These findings indicate a context influence on the cognitive load of students solving inquiry problems caused by the scientific discipline.*

**Keywords:** Scientific Inquiry, Cognitive Load, Biology, Chemistry, Tasks

### Introduction

#### **Scientific Inquiry in Science Education**

The current emphasis on scientific literacy in international chemistry and biology education research highlights the role of concepts going beyond a simple understanding of chemical ideas and concepts. That includes besides content knowledge skills and knowledge concerning an understanding of how science gains new knowledge and which properties this knowledge has [1].

In the international discussion similar ideas occur under the labels “Scientific Inquiry”, “Nature of Science” and “Nature of Scientific Inquiry”. These terms cover a complex set of ideas, beliefs, and pedagogies that, over the past 40 years, has achieved much attention with little agreement [2]. However, they figure prominently in educational standards of different countries [3-4]. The National Research Council defines scientific inquiry as “the diverse ways in which scientists study the natural world and propose explanations based on the evidence derived from their work”.

#### **Lack of Research**

Looking at educational practice research shows that amount of inquiry present in science classrooms is limited [5]. Influencing factors like a lack of planning and instructional time, insufficient materials, and inadequate professional development have frequently been cited in the research literature [6]. However, only little attention has been paid on the context's influence on the performance of students solving inquiry problems and the implementation of scientific inquiry in science lessons by science teachers.

Against this background, the purpose of this study was to examine the influence of the science context on the students' cognitive load while solving inquiry problems. A high cognitive load could be a responsible factor for a different performance of students being confronted to this kind of problems. Therefore, 180

multiple choice tasks assessing cognitive skills in scientific inquiry were constructed with reference to science education theory and given to students aged 15 [7]. The cognitive load of students working on these items was assessed.

### Theoretical Framework

Based on contemporary science education theories [8-9], a two dimensional theoretical structure describing scientific inquiry in chemistry and biology has been developed. It defines three *inquiry methods* (modelling, experimenting, observing) and three steps of *scientific reasoning* (formulating questions and hypotheses, planning and performing, analysing and reflecting) [7].

Inquiry Methods	Scientific Reasoning		
Modelling	M1	M2	M3
Experimenting	E1	E2	E3
Observing Comparing Arranging	B1	B2	B3
	Question and Hypothesis	Plan and Performance	Analysis and Reflection

**Figure 1** Theoretical structure describing scientific inquiry as a combination of Inquiry Methods and Scientific Reasoning

#### *Observing*

An observation is a conscient, purposeful and theory driven activity. It is a form of perception that requires a question or an objective and is carried out in a methodically-organized manner. Observations rely on sensory perceptions. This includes all kind of senses, even those, who are made possible by the use of auxiliary means. As observations are based on a certain objective, they focus on certain criteria and neglect others. The observer has to distinguish between relevant or non-relevant information [10]. Furthermore, observations are made without manipulating the objects of investigation fundamentally in order to verify or falsify correlative hypothesis. A fundamental manipulation can be defined as changes that affect the object and its properties in a non-natural way. That does not automatically mean that the observer's role is passive. Manipulations can be done without changing the properties under investigation. The control of the frame conditions does not constitute a fundamental manipulation as it has no impact on the properties under investigation.

#### *Comparing and Arranging*

Comparisons relate two objects on the basis of at least one criterion. They are therefore defined as tripartite relations which purpose is to identify similarities and differences of objects [11]. In contrast, classifications involve objects with the aim of grouping and categorizing them. Both inquiry methods rely on the use of criteria. Concerning comparison, it is important to use a single criterion for all objects. Changing a criterion during a comparison means to falsify the results. Classifications can be done on the basis of multiple criteria. However, one has to avoid an alteration within a classificatory system.

#### *Experimenting*

The inquiry methods differ from each other in terms of the purpose they are applied for. Accordingly, conducting experiments means to purposively intervene in objects. To discover or verify causal hypothesis, frame conditions influencing the object under investigation are changed systematically. By

isolation, variation or combination of relevant factors principles concerning interconnections of relevant variables can be derived [12].

### ***Modelling***

Models play a vital role in science as they provide a wide range of functions [13]. They visualize complex phenomena, represent abstractions more concretely, allow predictions to be made and serve as basis for explanations of empirical data. According to Mahr [14] an object oriented definition of what a model is cannot be given. What is to be considered as a model depends on the viewpoint of a subject [15]. Concerning models in scientific inquiry the focus is on the application of models to gather new knowledge. This application is determined by a purpose like generating hypothesis, predicting characteristics of an object or explaining phenomena. Having clarified the purpose, a mental model is to be chosen, derived or produced [16]. In order to generate data, the model has to be transformed into a material, visual, verbal or mathematical representation. On this basis, the empirical testing takes place. This includes the design and conduct of practical work to collect and analyse data. This process may even start from an exploration of the model's implications through thought experimentation conducted in the mind [13]. Finally, the results are evaluated with regard to empirical data. If the model fails at this stage, an attempt has to be made to modify the model and to restart model-based processes of scientific inquiry.

### ***Cognitive Load Theory***

Describing learning as schema construction this theory proposes a general framework for the conditions of learning with regard to contents, environments and instructional materials [17]. It comprises three different types of cognitive load:

- 1) Intrinsic cognitive load
- 2) Extrinsic cognitive load
- 3) Germane cognitive load

While extrinsic and germane cognitive load is generated by the way information is presented and the way schemas are constructed by the individual the intrinsic cognitive load describes the inherent difficulty of instructional content. Although some schemas may be divided into subschemas to facilitate learning processes the influence of the instructional content does not allow an alteration of the intrinsic cognitive load [18].

### **Rationale and Research Questions**

Biology as a science discipline is concerned with the study of living organisms, including their structure, function, growth, origin, evolution, distribution, and taxonomy [19]. Chemistry dealing with the nature of matter, especially its chemical reactions, its composition and properties focuses on its macroscopic but also on its submicroscopic and symbolic level. Especially these two elements tend to be abstract and complex [20]. If these characteristics influence students doing inquiry a higher cognitive load could be responsible for a different performance of students doing inquiry in different contexts. Accordingly, the study focused on two primary research questions:

- 1) Does the cognitive load of students working on inquiry problems from chemistry and biology differ?
- 2) Does the cognitive load of students working on different inquiry methods differ?

### **Methods**

#### ***Inquiry tasks in biology and chemistry***

This study used a descriptive quantitative approach employing a total number of 180 inquiry tasks. These assessed cognitive skills in scientific inquiry and referred to the inquiry methods and steps of scientific thinking defined by the theoretical structure. Participants had to solve typical inquiry problems related to

the formulation of hypotheses, the planning of experiments, observations and models and the analysis of data derived from these types of investigation. One half of these tasks used biological contexts (plant physiology, ecology, microbiology), the other half chemical contexts (salt, ion bonding, chemical reaction). All contexts are part of Berlin school curriculum for chemistry and biology for the 9<sup>th</sup> and 10<sup>th</sup> grade. As we used a rotated test design participants had to solve 27 tasks for chemistry and biology each. These items were aggregated separately in booklets for chemistry and biology. Formal item characteristics like text length, graphical information, instructions and questions were kept constant. Thus, elements causing differences between these items can be traced back to discipline specifics.

### **Cognitive Load**

In order to assess the cognitive load of the participants we used a 6-item scale [20]. These items had to be answered thrice a test booklet after 9 items per inquiry method each (observing, experimenting, modelling). The instrument showed an excellent internal consistency ( $\alpha = 0.92$ ). An exploratory factor analysis (Varimax Rotation, Kaiser-Stopping-Criterion) showed one single factor explaining 70.48 % of the variance with factor loadings ranging from 0.79 to 0.88. These findings support the assumption that a single latent construct is measured by the instrument.

### **Sample and Data Collection**

Data were collected 2012 in eight Berlin Schools. The average age of the participants is 15.3 years (SD = 0.81). 56 % of the participants were female and 44 % male. The total sample comprises 428 participants (100 %). Out of these 78.0 % worked on chemistry inquiry tasks and 47.9 % on biology inquiry tasks. 25.9 % performed on chemistry as well as on biology. All analysis comparing the cognitive load will be based this sub-sample (N=111).

### **Results**

Table 1 includes descriptive results from cognitive load items arranged by inquiry methods and scientific context as well as results from the *t*-Tests.

**Table 1** Descriptive results and results of *t*-Tests comparing means of cognitive load between chemistry and biology inquiry tasks

Inquiry Method	Cognitive Load - Chemistry		Cognitive Load - Biology		<i>t</i> -Test		
	Mean	SD	Mean	SD	T	Df	p
<b>Observing</b>	19,23	6,26	15,25	6,01	5.277	82	< 0.001
<b>Experimenting</b>	18,95	6,33	16,87	5,77	3.300	90	0.001
<b>Modelling</b>	19,61	6,13	17,83	6,30	2.584	83	0.012

The data showed significant differences between chemistry and biology for all three inquiry methods. The cognitive load of chemistry inquiry tasks is perceived to be higher. Looking at effect sizes, we could find medium and small effects (Observing:  $d=0.65$ , Experimenting:  $d = 0.35$ , Modelling:  $d = 0.29$ ).

Table 2 presents descriptive results from cognitive load items arranged by scientific contexts and results from the One-Way-ANOVA comparing the means for all three inquiry methods of one scientific discipline.

**Table 2** Results of One-Way-ANOVA comparing means of cognitive load of inquiry tasks for different inquiry methods

	Inquiry Methods	One-Way-ANOVA			F	p		
		Observing	Experimenting	Modelling				
	Mean	SD	SD	Mean	SD			
<b>Chemistry</b>	19,23	6,26	6,33	19,61	6,13	2, 0.51	0.950	
<b>Biology</b>	15,25	6,01	5,77	17,83	6,30	2, 2.468	0.087	

Although we could observe slight differences between the means of the inquiry methods within one scientific discipline, these differences did not turn out to be significant. Even if the means for observing and modelling for biology differ, these differences have no or just a slight practical meaning as the effect sizes show (chemistry:  $\eta^2 < 0.000$ , biology:  $\eta^2 < 0.017$ ).

Table 3 summarizes the correlations of the cognitive load scores for the three inquiry methods arranged by scientific discipline.

**Table 3** Correlation analysis of cognitive load scores for different inquiry methods and different scientific disciplines (Pearson product-moment correlation). All correlations are significant on the 1 % level ( $p < 0.01$ ).

Cognitive Load		Chemistry			Biology		
		Observing	Experimenting	Modelling	Observing	Experimenting	Modelling
<b>Chemistry</b>	Observing						
	Experimenting	.847					
	Modelling	.839	.853				
<b>Biology</b>	Observing	.375	.426	.469			
	Experimenting	.494	.510	.542	.810		
	Modelling	.455	.544	.488	.807	.814	

These results show positive correlations for all inquiry methods. That means students tend to perceive quite similar cognitive load no matter if it is a higher or lower. Strong correlations only appear within a discipline ( $.810 \leq r \leq .853$ ) while correlations between chemistry and biology can be interpreted as being medium ( $.375 \leq r \leq .542$ ). These values show that we found between 14.1 % and 29.4 % of the variance to be common between chemistry and biology.

## Conclusion

### Summary

In this study we investigated the context's influence on the cognitive load of students working on chemistry and biology inquiry tasks. Working with 90 inquiry tasks for chemistry and for biology each we used a 6 item scale with an excellent internal consistency to investigate the cognitive load's perception of 15 year old students. Formal characteristics were kept constant to not bias the context's influence.

### Research Questions

Concerning our first research question the analysis revealed significant differences for cognitive load scores between inquiry tasks for chemistry and for biology. Including medium to small effect sizes the cognitive load of chemistry tasks is perceived to be higher. Concerning our second research question the data showed no significant differences between the inquiry methods within chemistry or biology. The perception of the inquiry methods within a scientific discipline seems to be quite similar.

### Explanations of Findings

In order to explain these findings we assume that we could have found here an effect of the science discipline. It is not clear if this effect is caused by the scientific content or even by the participants' expe-

ctations as chemistry is perceived to be a difficult school subject. However, the higher score of inquiry tasks containing biological models highlights the influence of the content on the cognitive load. The moderate values of common variance (between 14.1 % and 29.4 %) indicate a moderate influence of the formal task characteristics as and the common theoretical framework being the basis for task construction. Further research has to clarify whether these differences influence the students' performance while solving inquiry problems.

## References

- [1] W. A. Sandoval, B. J. Reiser, *Science Education*, 2004, DOI: 10.1002/sce.10130
- [2] L. H. Barrow, *Journal of Science Teacher Education*, 2006, DOI: 10.1007/s10972-006-9008-5
- [3] National Research Council, *National Science Education Standards*, National Academy Press, Washington, DC, 1996
- [4] KMK, *Bildungsstandards im Fach Chemie für den Mittleren Schulabschluss (Jahrgangsstufe 10)*, Luchterhand, München 2005.
- [5] M. Fenichel, H. Schweingruber *Surrounded by science: Learning science in informal environments*, The National Academies Press 2010.
- [6] W. Breslyn, J. R. McGinnis, *Science Education*, 2012, DOI: 10.1002/sce.20469
- [7] A. Nehring, K. H. Nowak, A. Upmeyer zu Belzen, R. Tiemann, *Jahrestagung der Gesellschaft für Didaktik der Chemie und Physik*, Oldenburg, p. 301
- [8] American Association for the Advancement of Science (2009): *Benchmarks online: The Nature of Science*. <http://www.project2061.org/publications/bsl/online/index.php?chapter=1>. Accessed 20 August 2012
- [9] D. Klahr, *Exploring Science*, The Mit Press, Cambridge 2002.
- [10] N. Wellnitz & J. Mayer: *Evaluation von Kompetenzstruktur und –niveaus zum Beobachten, Vergleichen, Ordnen und Experimentieren*, *Erkenntnisweg Biologiedidaktik*, In: D. Krüger, A. Upmeyer zu Belzen, T. Riemeier, K. Niebert (eds.) *Erkenntnisweg Biologiedidaktik* 7, pp. 129-144, VBio, 2008
- [11] J. Arnold, N. Wellnitz & J. Mayer: *Beschreibung und Messung von Beobachtungskompetenz bei Schülerinnen und Schülern der Sekundarstufe I*, In: D. Krüger, A. Upmeyer zu Belzen, S. Nietz (eds.) *Erkenntnisweg Biologiedidaktik* 8, pp. 7-22, VBio, 2010
- [12] P. Janich, M. Weingarten, *Wissenschaftstheorie der Biologie*, UTB, Stuttgart 1999.
- [13] R. Justi, J. Gilber: *The Role of Analog Models in the Understanding of the Nature of Models in Chemistry*. In: P. J. Aubusson, A. G. Harrison, S. M. Ritchie (eds.) *Metaphor and Analogy in Science Education*, pp. 119-130, Springer, Dordrecht 2006.
- [14] B. Mahr, *Informatik Spektrum*, 2009, DOI 10.1007/s00287-009-0340-y
- [15] B. Mahr, *Das Wissen im Modell*, KIT-Report Nr. 150, Berlin 2004.
- [16] C. J. Boulter & B. C. Buckley: *Constructing a typology of models for science education*. In: J. K. Gilbert, C. J. Boulter (eds.) *Developing models in science education*, pp. 41-57, Dordrecht, Kluwer, 2000
- [17] J. Sweller, J. J. G. van Merriënboer, F. G. W. C. Paas, *Educational Psychology Review*, 1998, DOI: 10.1023/A:1022193728205
- [18] J. Sweller, *Learning and Instruction*, 1994, 4, 4, 295-312
- [19] Texas State University. *Glossary*. <http://www.bio.txstate.edu/~wetlands/Glossary/glossary.html>. Accessed 20 August 2012
- [20] A. H. Johnstone, *J. Chem. Educ.*, 1993, DOI: 10.1021/ed070p701

## Inquiry-Based Learning in Japan

Haruo OGAWA<sup>1</sup>, Hiroki FUJII<sup>2</sup>

<sup>1</sup>*Department of Chemistry, Tokyo Gakugei University, 4-1-1 Nukuikitamachi, Koganei, Tokyo 184-8501, Japan  
E-mail: ogawah@u-gakugei.ac.jp*

<sup>2</sup>*Department of Science Education, Graduate School of Education, Okayama University, 3-1-1  
Tsushimanaka, Kita-ku, Okayama 700-8530, Japan*

### **Abstract**

*Challenges of inquiry-based instruction in Japan have so far been advocated by the Ministry of Education, Culture, Sports, Science and Technology (MEXT) with the guidelines of the Courses of Study. Though it is regrettable, systematic teaching methods are not established and actually there is almost no example of systematic instructions until now in third-level chemistry, even from primary schools through upper secondary schools by the reason of adoption of the methodology by a teacher's discretion. Of course, in the corresponding schools, inquiry-based instruction has been individually advanced by discretion, and appropriate success has been achieved. Recently, the trial which gazes at inquiry-based instruction has come to be seen with university's own discretion as preparation of graduation research. The current situation and trials of inquiry-based instruction mainly on tertiary education in Japan ("Super Science High Schools" in high school education is also within a view as reference) are introduced.*

**Key words:** Inquiry-based learning, inquiry-based instruction, higher education in Japan, third chemistry, graduation research, project learning

### **1. Introduction**

Challenges of inquiry-based instruction in Japan have so far been advocated by the Ministry of Education, Culture, Sports, Science and Technology (MEXT) with the guidelines of the Courses of Study [1]. Though it is regrettable, systematic teaching methods are not established and actually there is almost no example of systematic instructions until now from primary schools through upper secondary schools by the reason of adoption of the methodology by a teacher's discretion. Of course, in the corresponding schools, inquiry-based instructions have been individually advanced by discretion, and appropriate success has been achieved. Recently, MEXT is enforcing Super Science High Schools (SSH) which focus their education on science and math putting practice of inquiry learning on importance, and the Japan Science and Technology Agency supports them. In the university-level education, it is rare that systematic inquiry-based instruction is incorporated on a curriculum because graduation research is set up at the last reaching point on a curriculum as compulsory subject at almost all Japanese universities. The graduation research is performed along with the process of science on the basis of inquiry-based approaches. Recently, the trial which gazes at inquiry-based instruction has come to be seen with university's own discretion as preparation of graduation research. In this session, the current situation and trials of inquiry-based instruction mainly on tertiary education in Japan (high school education is also within a view) are introduced.

### **2. Circumstances and present condition**

#### **2.1 higher education in Japan**

Competencies to be acquired through bachelor's abilities: reference guideline for learning results common

among bachelor courses; it is recommended that university clarify its policy for awarding academic degree based on each item in such reference guidelines. Some examples are advocated. As “Knowledge / Understanding,” in addition to systematic understanding of the basic knowledge of a specific field of major, understanding of many and different cultures and understanding of human culture, society and nature is recommended, as “General-purpose skills,” skills required for intellectual activities as well as professional and social life as like communication skills, numerical competence, information-technology, logical thinking and problem solving skills, and as “Comprehensive learning and its application,” the ability is required, with which a person can comprehensively utilize the knowledge, skills, behaviors and other experience acquired to date to successfully apply such experience to solving new issues. Each university clarifies its policy for awarding academic degree, and the curriculum is made up with its policy, individually. Inquiry-based instruction is incorporated on a curriculum at the last reaching point on a curriculum as compulsory subject at almost all Japanese universities. The graduation research is performed along with the process of science on the basis of inquiry-based approaches. Through the practice of the process, students raise the ability to design and conduct scientific investigations, formulate scientific explanations using experimental evidence, and effectively communicate the results of scientific investigations. Especially in natural science, it is considered that acquisition of knowledge and skill based on a framework of scientific system is very important, and adequate special-subjects are put weight on it as the preparatory step towards graduation research. This view has not been an exception even in a subject experimental. Recently, the trial which gazes at inquiry-based instruction has come to be seen with university’s own discretion as preparation of graduation research.

## ***2.2 Case of Tokyo Gakugei University as one of typical example***

Tokyo Gakugei University (TGU) is one of the national universities in Japan and has a reputation of Japan’s center of teacher education. Programs of student education consist of faculty of education consisting of Teacher Training Course and Liberal Arts Course, Graduate School of Education (Master’s Course), and United Graduate School of Education (Doctoral Course) [2]. Curriculum of teacher training course consists of liberal arts subjects, foundation subjects, content subjects, and graduation research positioning as a compilation (goal) of an educational program. In the case of learning program for chemistry course student [3], sufficient lectures and experiments required for chemistry research are incorporated, where as an experimental, four experiments of “Chemistry,” “Physical chemistry,” “Inorganic chemistry,” and “Organic chemistry,” are adopted.

### ***2.2.1 “Generalization-Project” learning as a liberal arts subject***

It is usually referred to as “Project learning” in TGU (Fig. 1). Policy is stated as follows, project learning consists of buildup approaches as preliminary quasi-graduation research for second grader by support of one year and about 3 to 4 professors through scientific methodology [4]. The research activities including extracurricular activities for one year are expected. Three compulsory subjects in seven fields are set up for all the students. Twenty eight themes in 2009 were set up, and eight examples related with science were stood as a candidate. Each student chooses and studies one theme which is separately pleasing. Each theme is put weight on inquiry-based learning as the preparatory step towards graduation research. Typical methodology of science including the procedure of integration of results, hypothesis, modeling, and verification should sustainably be repeated and repeated by scientists, as much as any other profession. Even in subject of “Project learning” it is desirable that students should educate themselves in a similar manner with their tolerance through research.



## Subject of “Project Learning” for all students

### Policy

Project learning consists of buildup approaches as preliminary quasi-graduation thesis for second grader by support of one year and about 3 to 4 professors through scientific methodology. The research activities which let while [ one year ] including extracurricular activities are expected.

### Subject (compulsory)

1. Project study subject 1 (2 units)
2. Project study subject 2 (2 units)
3. Comprehensive exercise (2 units)

(including extracurricular activities; open inquiry)

### Field

- Children -School -Family
- Health -Region -Welfare
- International understanding
- Information
- Science & Technology
- Environment
- Expression

### Theme: 20 themes in 2009

#### Example related with science

- Ethical of natural science
- Modern society and change of a substance
- Present and the future of life science
- Space earth science using educational establishment or teaching materials
- Risk assessment
- Preservation and practical use of cultural assets
- Environmental education in the suburbs
- History of nature of Tama River

Fig. 1. “Project learning” in Tokyo Gakugei University

### 2.2.2 “Physical chemistry experiment” as a special subject

Contents of physical chemistry experiment are listed in Table 1. The experiment is conducted by the theme which made full use of instrumental analysis technique. Flow of the lesson is shown in Table 2. Interview at the step 5 is a key for checking how target attainment was accomplished.

**Table 1.** Contents of “Physical Chemistry Experiment”

- 1) Detection of bi-radical of DPPH (2,2-diphenyl-1-picrylhydrazyl) by ESR measurement
- 2) Adsorption of benzoic acid to alumina (adsorption isotherm) by UV and FT-IR measurements
- 3) Thermodynamic calculation with heat measurement of KCl and/or NaCl dissolution
- 4) Determination of Avogadro constant by XRD measurement

**Table 2.** Flow of the lesson

- Step 1. Data distribution about an experiment (beforehand)
- Step 2. Basic and deployment experiments (3 or 4 LH, 1LH=4.5h)
- Step 3. Arrangement of results
- Step 4. Report creation (home work)
- Step 5. Interview (office hours, individually)
- Step 6. Acceptance of report

### 2.2.2.1 Thermodynamic calculation with heat measurement

Student measures the heat of potassium chloride KCl dissolution in water by infinite dilution method and calculates enthalpy change of the dissolution  $\Delta H_{\text{dissol}}$  through the basic experiment [5]. As deployment work, student searches literatures of enthalpy change of lattice  $\Delta H_{\text{lat}}$ , and then finally the number of hydration should be calculated by the entropy method with total enthalpy change of the hydration  $\Delta H_{\text{hyd}}$ .

### 2.2.2.2 Determination of Avogadro constant by XRD measurement

Quadratic prism of sodium chloride NaCl is formed from halite by cleavage. The density is evaluated from the size and the gravity. On the other hand, XRD pattern of granular halite is measured and analyzed to obtain the crystalline lattice and the geometry of NaCl by use of our developed program on PC (Fig 2) [6]. As deployment work, student determines their own Avogadro constant based on obtained data.

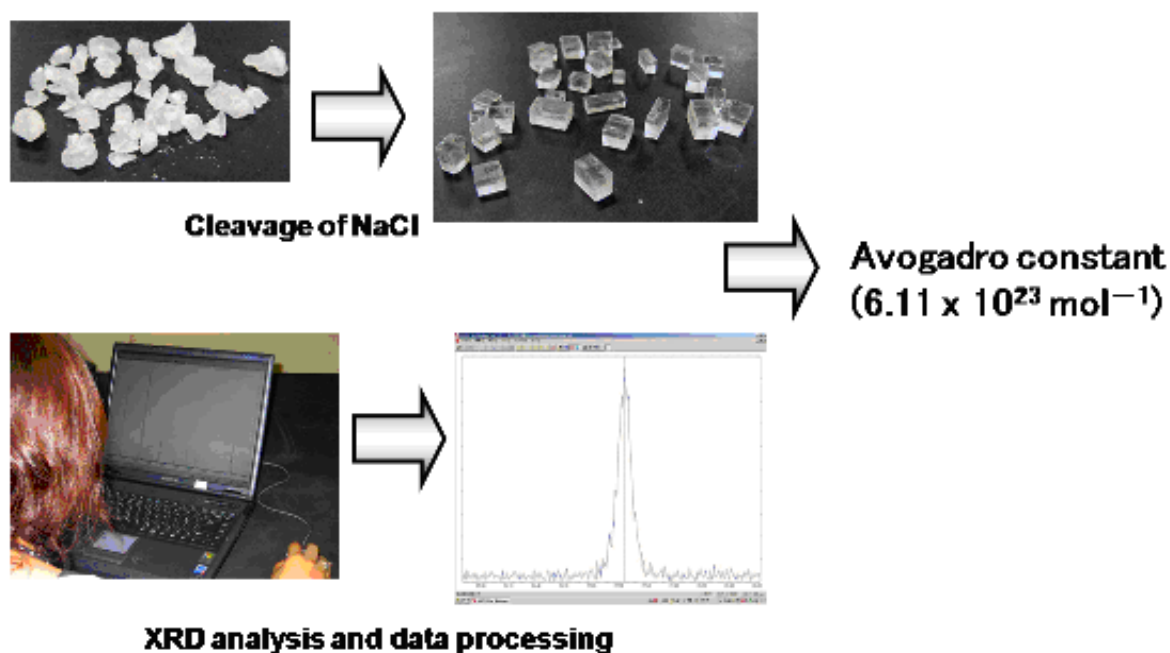


Fig. 2. Determination of Avogadro constant

### 2.2.2.3 Adsorption of benzoic acid (BA) to alumina by UV and FT-IR measurements

Student makes the adsorption isotherm from the data measured by the experiment at a certain temperature by UV absorption (Fig. 3) and carries out the verification of the obtained isotherm on the basis of Langmuir equation. On the other hand, student analyzes the IR absorption spectra obtained by FT-IR measurement of the adsorption samples of a certain amount of BA [7]. Student ultimately proposes a model of BA adsorption on alumina vs. a covering rate  $\theta$  (Fig. 4) as deployment work. Student also proposes the experimental planning for obtainment of the thermodynamic properties of  $\Delta G_{\text{ad}}$ ,  $\Delta H_{\text{ad}}$ , and  $\Delta S_{\text{ad}}$ .

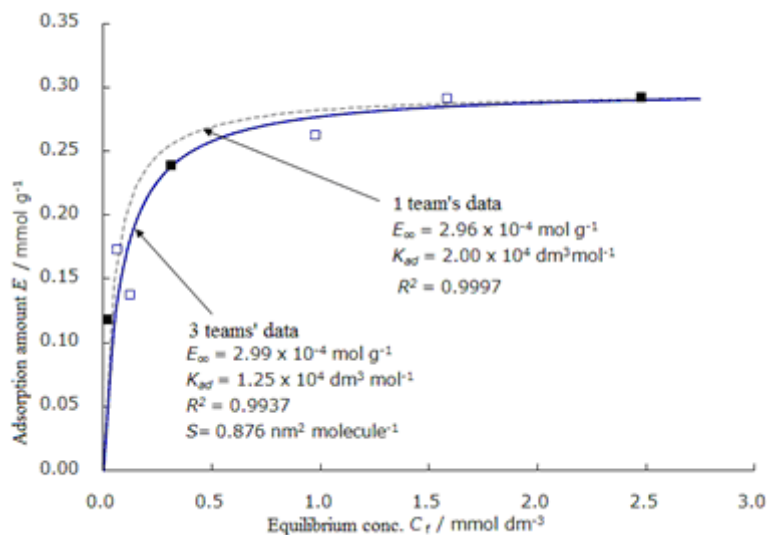


Fig. 3. Adsorption isotherm of BA on alumina (290K)

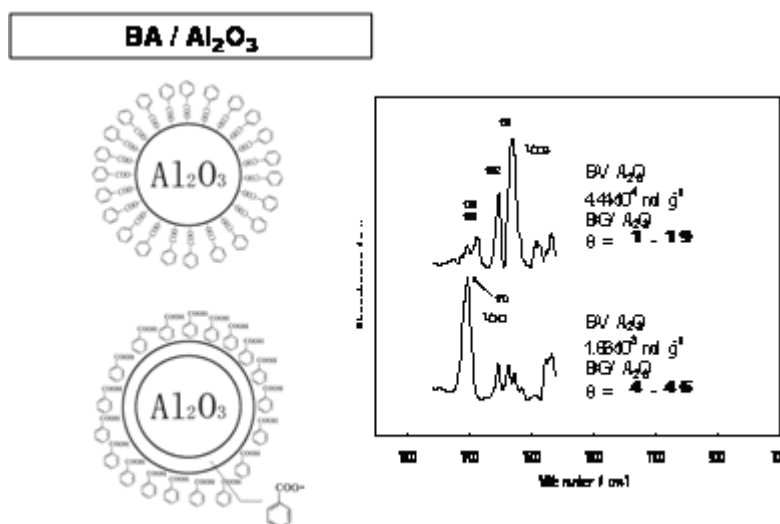


Fig. 4. Proposed model of BA adsorption on alumina

### 2.3 Operation in secondary education continuing to university education

The Course of Study of high school science in Japan was revised in 2009, in which the subject of "Science Subject Research" was newly established for the purpose of the cultivation of a base of students' creativity through the inquiry-based learning [8]. There is almost no example of systematic inquiry-based instructions even in upper secondary schools by the reason of adoption of the methodology by a teacher's discretion. Research of this field in the high school chemistry develops individually, however neither systematic research on proper contents of lesson nor effective teaching and learning methods is regrettably shown. Of course, inquiry-based instructions have been individually advanced by discretion in specific schools, e.g. one of the schools burdens all the students with graduation thesis, and appropriate success has been achieved [9]. Recently, MEXT is enforcing Super Science High Schools (SSH) which focus their education on science and math putting practice of inquiry learning on importance, and the Japan Science and Technology Agency supports them. Outline of SSH is described below, in order to raise the future international talented people who engage technology relations, the high school which

carries out the advanced number education of science and math is made into SSH. It specifies and supports the experiential, problem-solving study, *etc.* through development and practice of the curriculum, irrespective of the government guidelines, for teaching, subject research promotion, observation, an experiment, *etc.* The adopted high school is managed along with each following theme target,

- Experiential and problem-solving study through observation, experiment, *etc.*
- Promotion of subject research.
- Strengthening of linguistic capacity required in order to raise internationalism.
- Research of the teaching method which improves creativity and originality.
- Positive participation in an international technology contest, *etc.*

Selected SSH has amounted to 145 schools including 29 as the Core SSH in 2011 and is aimed at 200 schools by 2014.

### 3. Conclusion and Discussions

Challenges of inquiry-based instruction in Japan have so far been advocated by the Ministry of Education, Culture, Sports, Science and Technology (MEXT) with the guidelines of the Courses of Study [1]. The subject of “Science Subject Research” was newly established for the purpose of the cultivation of a base of students’ creativity through the inquiry-based learning in high school-level science [8], and MEXT is enforcing Super Science High Schools (SSH) which focus their education on science and math putting practice of inquiry learning on importance. However, systematic teaching methods are not regrettably established, and actually there is almost no example of systematic instructions until now even upper secondary schools besides university-level education. Systematic research on proper contents of lesson for effective teaching and learning methods for inquiry-based instructions is expected eagerly.

Example of inquiry-based experiment in secondary chemistry has been proposed in 35 themes of experiments, in which the procedure of inquiry-based experiment is explained painstakingly [10]. One of the goals of teaching science should be teaching the process of science [11] and give students the opportunity to learn or appreciate the process of science. The 1996 NSES expect teachers to plan and incorporate inquiry into the science curriculum [12]. Some of the student outcomes listed in the NSES document include the ability to design and conduct scientific investigations, formulate scientific explanations using experimental evidence, and effectively communicate the results of scientific investigations. Research has shown that students using a laboratory-investigative approach show significant gains in formulating hypotheses, making assumptions, designing and executing investigations, understanding variables, making careful observations, recording data, analyzing and interpreting results, and synthesizing new knowledge, as well as the development of curiosity, openness, responsibility, and satisfaction [13]. Research usually needs patience, and this is one of the important factors in science research. Teachers stance, how teachers can successfully incorporate inquiry into the laboratory without overwhelming themselves or the students [14], is needless to say also important.

Creative thinking is a key for students to have images of objectives as in phenomena, chemical concepts, and molecular world in chemistry through inquiry-based learning as like problem-solving, subject research, *etc.* [15] It is important for student to have thinking and behaving imaginatively, and finally to have an outcome which is of value to the original objective [16-17]. Promoting creativity in science has been reported and discussed in papers [18-23]. Scientists, as much as any other profession, are passionate and involved humans whose work relies on inspiration and imagination as mentioned by Osborne [19]. Even in science education it is more desirable that students should educate themselves in a similar manner. Thinking and behaving imaginatively in science would be important to promote creativity as outcome with value to the original objective [16-17, 23-24]. Child and/or Osborne, *et al.* mentioned that students should appreciate that science is an activity that involves creativity and imagination as much as many other human activities, and that some scientific ideas are enormous intellectual achievements [18-19]. The learning on the basis of students’ enthusiastic activities on imaginative thinking and behaving would be of great importance to understand science. Realizing images led to understanding are expected

to be enhanced students' enthusiastic activities. Student's attitude being enthusiastic toward the possibilities of their own abilities with their own images would enhance the understanding of objectives besides with the hope of acquiring sufficient knowledge and skills through inquiry-based learning. Further development of the research on this field is sincerely expected.

## References

- [1] <http://www.mext.go.jp/english/a05.htm>; *ibid.* a06.htm. Accessed 1 July 2012
- [2] Guidebook of Tokyo Gakugei University, 2011; [www.u-gakugei.ac.jp](http://www.u-gakugei.ac.jp). Accessed 1 July 2012
- [3] H. Ogawa and T. Hasegawa, *Chemistry & Education*, 1999, **47**, 684-685. (in Japanese)
- [4] H. Ogawa, *Chemistry & Education*, 2000, **48**, 505-507. (in Japanese)
- [5] A. Ikuo, Y. Yashinaga, S. Hasegawa, and H. Ogawa, *Bull. Tokyo Gakugei Univ. Natur. Sci.*, 2007, **59**, 27-35. (in Japanese)
- [6] A. Ikuo, N. Enuma, S. Teratani, S. Hasegawa, T. Shishid, and H. Ogawa, *Chemical Education Journal (CEJ)*, 2005, **8**, No. 2 (Serial No. 15), Reg. No. 8-10. (in Japanese)
- [7] H. Ogawa, T. Chihara, and K. Taya, *J. Am. Chem. Soc.*, 1985, **107**, 1365-1369; H. Ogawa, *J. Phys. Org. Chem.*, 1991, **4**, 346-352.
- [8] Ministry of Education, Culture, Sports, Science & Technology in Japan, *Course of Study of High School Science*, 2009.
- [9] "In writing a graduation thesis," Ed. Waseda University Senior School at Honjo, 2011.
- [10] American Chemical Society, "Inquiry-Based Experiment in Chemistry", Oxford University Press, Washington, D.C., 2000. ISBN 0-8412-3507-8
- [11] Benchmarks for Science Literacy: Project 2061, American Association for the Advancement of science. Oxford University Press, New York, 1993, 3.
- [12] Chemistry in the National Science Education Standards, American Chemical Society, Washington, DC, 1997, 19.
- [13] K. P. Raghubir, *Journal of Research in Science Teaching*, 1979, 13-17.
- [14] Chemistry in the National Science Education Standards, American Chemical Society, Washington, DC, 1997, 22-23.
- [15] Haruo Ogawa, article in the book of The 4<sup>th</sup> NICE (Network for Inter-Asian Chemistry Educators) Symposium, 2011, 4-15; H. Fujii and H. Ogawa, *Proc. Intern. Conf. EASE (East-Asian Association for Science Education)*, 2011, 62-68; H. Ogawa, H. Fujii, and Y. Ohashi, "Innovation in Science and Technology Education: Research, Policy, Practice", Ed Jack Holbrook et al, University Tartu, 2010, 253-256. (ISBN 978-9985-4-0607-6); H. Ogawa, H. Fujii, and M. Sumida, *The Chemical Education Journal (CEJ)*, **13**, No. 1, 13-1, (6 pages), 2009.
- [16] J. Wardle, *School Science Review*, 2009, **90** (332), 29-30.
- [17] R. A. Finke, T. B. Ward, and S. M. Smith. "Creative Cognition: Theory, Research and Applications," MIT Press, 1992.
- [18] E. P. Child, *Chem. Educ. Res. Pract.*, 2009, **10**, 189-203.
- [19] J. Osborne, M. Ratcliffe, H. Bartholomew, S. Collins, R. Millar and R. Duschl *Towards evidence-based practice in science education 3: teaching pupils 'Ideas-about-science'*, 2003, available at [http://www.tlrp.org/pub/documents/no3\\_miller.pdf](http://www.tlrp.org/pub/documents/no3_miller.pdf), accessed 15 Oct. 2010.
- [20] T. Jarvis, *School Science Review*, 2009, **90** (332), 39-46.
- [21] L. Höhn and G. Harsh, *School Science Review*, 2009, **90** (332), 73-81.
- [22] S. Longshaw, *School Science Review*, 2009, **90** (332), 91-94.
- [23] T. Ohshima, "*Rika Kyoujyu no Genri* (Principle of science teaching)," Doubunkan Co., 1920, 314-330. (in Japanese).
- [24] S. D. Domin, *Chem. Educ. Res. Pract.*, 2008, **9**, 291-300.

## Aspects Related to the Continuous Professional Development of Chemistry Teachers Stated in the Frame of PROFILES Training Program

**Radu Lucian OLTEANU<sup>1</sup>, Crinela DUMITRESCU<sup>1</sup>,  
Gabriel GORGHIU<sup>2</sup>, Laura Monica GORGHIU<sup>1</sup>**

<sup>1</sup> Faculty of Sciences and Arts, Valahia University Târgoviște, 18-24 Unirii Bd., 130082 Târgoviște, Romania

<sup>2</sup> Electrical Engineering Faculty, Valahia University Târgoviște, 18-24 Unirii Bd., 130082 Târgoviște, Romania  
E-mail: r\_olteanu@yahoo.com, Tel/Fax: 00400 245 213 382

### Abstract

*In Romania, the teaching career represents an important objective of the National Strategy of Development, being strongly related to the training process of the school personnel. It is important to emphasize that during the last years it was imposed moreover the need of continuously training of the teachers, both on theoretical and practical aspects. In fact, the success of the reforming process (in primary and secondary Romanian education system) depends on the continuous teachers' professional development, especially done in the frame of several programs who aim to gain specific competencies for teachers.*

*In this sense, the "PROFILES - Education through Sciences" training program is oriented on the improving of teaching activities, being organized in the frame of the European Project "PROFILES - Professional Reflection-Oriented Focus on Inquiry-based Learning and Education through Science" (code: 5.2.2.1-SiS-2010-2.2.1-266589), which has as objective to promote reflection-oriented teaching - where this enhances students' scientific literacy -, and to design a collaborative network, able to offer to Science teachers and researchers the possibility of active cooperation by promoting ideas and specific training materials, spreading the best practices, seminars, workshops etc.*

*The present paper illustrates the main aspects of the PROFILES continuous professional development program in Romania, its specific background and components, as well as results obtained during first phase of the training program.*

**Keywords:** "PROFILES - Education through Sciences" training program, Inquiry-based Science Education, reflection-oriented teaching, teachers competencies

### Introduction

The policies and strategies regarding the organizing of scientific education in Europe have as objective the improvement and the encouraging of Science teaching / learning process, keeping in view the stimulation and increasing of pupils' interest for Sciences. This aim can be obtained by changing the manner of Sciences teaching and also making a transition from the deductive form to that based on scientific inquiry [1].

In this context, in the frame of "PROFILES - Education through Sciences" program, the teachers' professional development was assured by the integration of all Science areas in the teaching process.

The "PROFILES - Education through Sciences" training program was developed and accredited - at national level - with the declared aim to respond to a clear necessity for Romanian Science teachers on promoting training reflection-oriented, pedagogical and scientific competencies, *Inquiry-based Science Education (IBSE)* and related approaches which can be implemented in the educational environment. More, the proposed training program, answered to the conclusions of the curricular *Delphi Study* (first stage), based on a clear methodology [2-4] and performed in the frame of *PROFILES* project [5-6] that involved in Romania more than 100 stakeholders in reflecting on contents and aims of Science Education, as well as in outlining aspects and approaches of modern Science Education.

## 1. General objectives of the training program

The general objective of the “*PROFILES - Education through Sciences*“ training program consists on the forming and developing of Sciences teachers competencies for achieving a didactic process based on scientific inquiry and integrated approach of the curricula. In the frame of the proposed program, a major importance was given to the promotion of the scientific and pedagogical teachers competencies, *IBSE* and related approaches, which can be implemented in the Romanian educational environment.

### 1.1. The correlation between training program objectives and Romanian standards

The objectives of the “*PROFILES - Education through Sciences*“ training program were established according to the Romanian continuously training standards, based on the needs of the target groups for developing new competencies, to be applied with the view of an efficient didactic process adapted to the national particularities and pupils’ needs.

The training program was elaborated according to the methodology of the accredited continuously training programs, offering the possibility for teachers to obtain 15 credits. The modules / themes included in the training program were selected based on a training needs analysis, the results of a first stage of Delphi study and the existent frame of professional and didactical competencies.

### 1.2. General competencies addressed by the training program

It is important to emphasize that in the present years it was imposed the need of implementing active learning programs, to make the transition from educational model based on the principle “learn to know” to that based on “learn to make”. Thus, the redefining teacher’s role and the changing of social characteristics of this profession became the main factors of designing and developing of training programs.

Of course, the teacher must have certain competencies that will allow him/her to develop a qualitative educational process adapted to the pupils’ particularities, starting with communicating competencies and ending with competencies related to the use of computers use in the teaching / learning process.

The general and specific competencies of the training program are in concordance with the Romanian standards, reflecting specific competencies from the national professional standards: methodological, communicating and relationship, evaluating, technical and technological, career management competencies etc.

## 2. Structure of the training program

The structure of the training program consisted of two modules:

- 1) Modern approaches on Science teaching;
- 2) Teaching oriented Inquiry Based Science Education.

For each of the training modules, general and specific competencies, content units, types of activities (lecture, practical applications and evaluation), allocated time, methods and instruments for evaluation, recommended bibliography, were described.

Based on the training program objectives, teachers proposed contents, strategies, activities related to the students needs and designed learning modules according to the structure of the program.

### 2.1. Training strategy

For achieving the proposed objectives, planned and managed related resources (human, material, financial, information), but also didactical strategies were established. There were used interactive strategies which stimulated active involvement of the students during training activities that allowed them to develop abilities, skills, competencies, understanding and self-evaluation capabilities.

The didactic approaches were structured in order to emphasize modern strategies, allowing the students to be active, formulate ideas and opinions, debate, experiment, as methods to access the theories and practices offered by a specific content. The learning environment was based on action, research, experimenting and offered the possibility to practice a qualitative act of learning that led to long term acquisitions that can be used and applied in various training and practical contexts.

The training / improving of the general competencies was made during the whole training program, based on the identified training needs.

### 2.2 Methods and training techniques

The training program promoted active methods and learning techniques that had in view the use of new didactic technologies: lecture-discussion, discussion, demonstration, panel discussion, questioning, case study, brainstorming, methods and techniques used for cooperative learning, experiment, role-gaming, project, SWOT analysis etc.

Those methods and techniques had positive effects in the frame of own cognitive development (critical thinking), creativity, teamwork capacity, cooperation / collaboration spirit, solving problems, allowing the students to practice their pedagogical competencies and put in value their didactical experience.

### 2.3. Forms and modalities to organize and develop the training activities

The training program had in view to make compatibles the planned activities with adult learning particularities. The “*PROFILES - Education through Sciences*” training program proposed theoretical and applied activities that put in value the cognitive, affective and active students’ resources.

The activities of the training program are structured as frontal (lectures), micro-group (applied activities) and individual (projects, reflection themes). All forms and modalities for organizing and development of the activities are designed in accordance to target group particularities, keeping in touch the adult specific ways of learning, students’ own learning capabilities and appealing to the use of experiences.

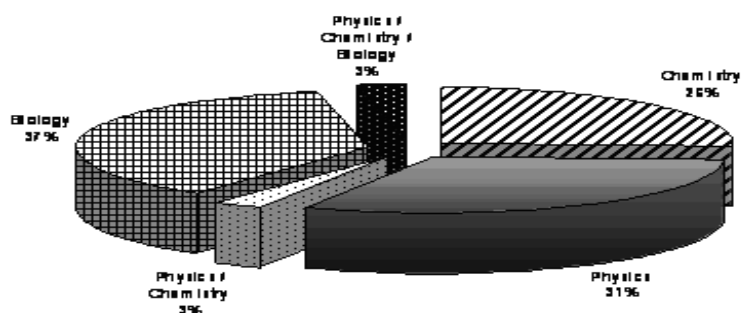
### 2.4. Forms and methods of evaluation

The evaluation assessed the way of knowledge transfer in the current practice and the manner in which the students demonstrate the acquisition of the required competencies. The methods used for evaluation were: portfolio-project (individual or group work), case studies, themes of reflection etc.

The final evaluation was made by public presentation of a project composed by 5 specific sections: *Introduction, Student’s activities, Teacher’s Guide, Evaluation and Teacher’s Notes*. The scale used for the evaluation of the portfolio was defined by using the following rates: *excellent, very well, well, enough, not enough*.

## 3. Structure of the target group

The target group was established based on the programmatic requirements and realities of Romanian schools, being composed of teachers from primary and secondary level from Dambovit County (Chemistry, Physics and Biology), as is shown in figure 1. The recruiting and selection of target group members was made respecting the equal opportunities principle, avoiding discrimination, assuring access and equal involvement of all students in the training activities.

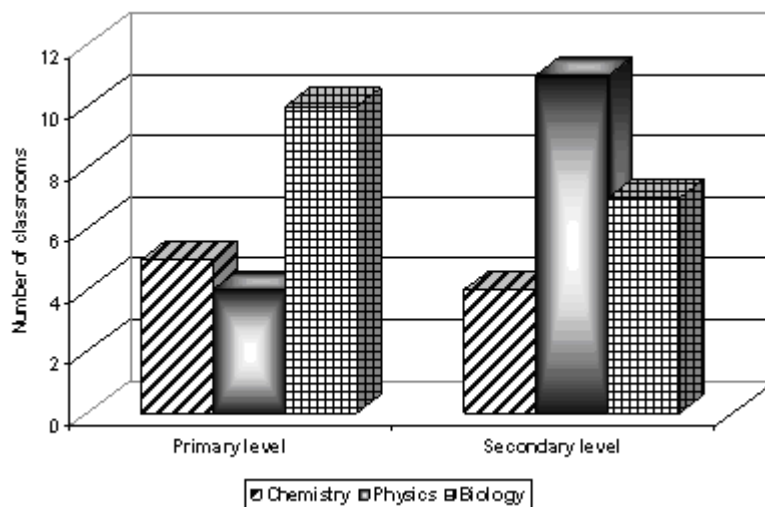


**Figure 1** Distribution of the target group involved in the “*PROFILES - Education through Sciences*” training program

Related to the implementation of the *PROFILES Modules*, there were involved 1100 (initially) and 1022 (finally) questioned pupils; the initial and final questionnaires were designed to obtain - among other issues - pupils’ views on the “ideal” lessons which they like to attend in the area of Science respectively



their views on the “actual” or “real” lessons in the same area [7]. The implementation was made on 41 classrooms: 22 from primary level 19 from secondary level, as is shown in figure 2.



**Figure 2** Implementation of the PROFILES Modules at various educational levels

#### 4. Conclusions

The “*PROFILES - Education through Sciences*” training program has proved to be - from the beginning - an essential training program for the professional development of Sciences’ teachers in the actual Romanian context. As results, successful implementations with positive pupils’ feedback were achieved. In the end, it was noticed a high interest regarding the teaching / learning process approach from Sciences’ teachers and pupils, especially.

#### Acknowledgments

This work was funded through the Seventh Framework Programme “*PROFILES - Professional Reflection Oriented Focus on Inquiry-based Learning and Education through Science*” No. 5.2.2.1 - SiS-2010-2.2.1, Grant Agreement No. 266589, *Supporting and coordinating actions on innovative methods in Science education: teacher training on inquiry based teaching methods on a large scale in Europe*. The support offered by the European Commission as well as the Community Research and Development Information Service as responsible for the management of EU’s programmes in the fields of research and innovation, through the project mentioned above, is gratefully acknowledged.

#### References

1. Eurydice, 2011. Science Education in Europe: National Policies, Practices and Research. Brussels: Eurydice, Romanian translation. [http://eacea.ec.europa.eu/education/eurydice/documents/thematic\\_reports/133RO\\_HI.pdf](http://eacea.ec.europa.eu/education/eurydice/documents/thematic_reports/133RO_HI.pdf). Accessed 10 June 2012
2. H.A. Linstone & M. Turoff (Hrsg.), *The Delphi Method: Techniques and Applications*, Reading, Mass. u.a: Addison-Wesley, 1975
3. C. Bolte, *A Conceptual Framework for the Enhancement of Popularity and Relevance of Science Education for Scientific Literacy, based on Stakeholders’ Views by Means of a Curricular Delphi Study in Chemistry*, *Science Education International*, 2008, 19(3), 331-350
4. J. Osborne, J. F. Ratcliffe, M. Collins, R. Millar & R. Dusch, *What “Ideas about-Science” Should Be Taught in School Science? A Delphi Study of the Expert Community*, *Journal of Research in Science Teaching*, 2003, 40(7), 692-720
5. C. Bolte, S. Streller, J. Holbrook, M. Rannikmae, R. Mamlok Naaman, A. Hofstein, F. Rauch, *Profiles: Professional Reflection-Oriented Focus on Inquiry based Learning and Education through Science*, *Proceedings of the European Science Educational Research Association (ESERA), Lyon, France, 2011*, (in press)
6. C. Bolte, S. Streller, M. Rannikmae, J. Holbrook, A. Hofstein, R. Mamlok Naaman, F. Rauch, *Profiles Projekt erfolgreich gestartet. In S. Unterricht. Zur Didaktik der Physik und Chemie. Probleme und Perspektiven*, Münster: Lit-Verlag, 2012, (in press)
7. C. Bolte, S. Streller, *Evaluating Student Gains in the PROFILES Project*, *Proceedings of the European Science Educational Research Association (ESERA), Lyon, France, 2011*, (in press)

## The Experiments with Isoprenoids in Chemical Education

Michala OPATOVA, Simona HYBELBAUEROVA

*Department of Teaching and Didactics of Chemistry, Faculty of Science, Charles University in Prague,  
Albertov 3, 128 43 Prague, Czech Republic  
E-mail: opatova.michala@gmail.com  
Tel: +420723435781*

### Abstract

*Isoprenoids are compounds often found in nature and can be divided into 2 groups, terpenoids (i.e. menthol,  $\beta$ -carotene, vitamin A, betulin) and steroids (i.e. cholesterol). They are used as an additive ( $\beta$ -carotene as substance to colour products, menthol for cooling effects) in food industry. Isoprenoids are also used in care products (menthol in toothpaste and shampoo, limonene in the beauty care) and medicine (steroids for eczema problems).*

*Frequent use of these compounds in common life is the reason why we introduce them and their properties to pupils. The chemical experiments are the best way how to learn about these compounds and their properties (solubility, reactivity, ability to crystallize, and polarity). During these activities the pupils practice basic laboratory techniques - extraction, crystallization, detection, isolation of isoprenoid from the natural materials or from food in supermarket, thin layer chromatography, column chromatography, using UV light, simple organic reaction and other techniques.*

*We prepared innovated experiments which demonstrate that different isoprenoids have similar properties. Other experiments exploit the similarity of isoprenoids with different types of compounds. In our article we mention experiments with menthol in candies, cholesterol from egg yolk, ester with menthol aroma (ethyl benzoate) and menthyl ester with floral aroma and other experiments.*

**Keywords:** isoprenoids, menthol, betulin, school experiments, chromatography

### 1. Isoprenoids in High School Chemical Education

The topic *isoprenoids* is discussed in high school in Czech Republic in the last year of chemical education. The pupil shall explain the structure and function of compounds [1]. According to the most often used textbook of chemistry in Czech Republic [2] there is focus on the basic unit – isoprene (2-methylbuta-1,3-diene) at first. These natural compounds are dividing into two groups, terpenes and steroids. The terpenes are divided into subgroups according to the number of basic units in the molecule and each group is described (important representatives, their structure, properties and presence). Steroids, derivatives of steran, are discussed less, teachers mention only the most significant examples of steroids such as cholesterol and steroid hormones, their structure and their effect on human health.

### 2. The Experiments with Isoprenoids in High School

The experiments with isoprenoids are not widely used in high school. One reason is short period of time given to this theme and that's why teachers don't have enough time to realize the experiments. Another reason is lack of laboratory work. Some high schools have only 4 hours of laboratory work during whole school year. Then the teachers choose experiments focused on other themes of organic chemistry or biochemistry. On the other hand experiments with isoprenoids can be integrated in the themes of general chemistry, i.e. in separating methods (chromatography, extraction, crystallization), solutions (solubility of isoprenoids, decolorize the solution) or the topic using nontraditional aids (UV light). Common experiments in this part of chemistry education which are realized in high school are distillation of essential oil (i.e. from citrus) and chromatography of plant's dyes.

#### 2.1 Experiments with Isoprenoids

Following five experiments are focused on isoprenoids which can be isolated from natural material and

can be used as substrate in chemical reaction. Some material containing isoprenoids can be bought in the supermarket (menthol candies) or it can be found in nature (betulin).

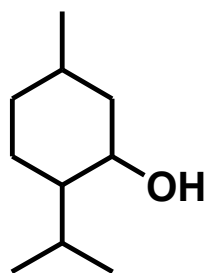
During laboratory work students can practice these methods: thin layer chromatography (TLC) or column chromatography (CC), extraction, crystallization, detection with chemical agent such as 10% sulphuric acid or with UV light. The first three experiments take more time (more than two hours) but the teacher can prepare part of the experiment during theoretical lesson in the class before planned laboratory work (i.e. extraction of natural material). The crystallization can be watched in class during week. The last two experiments are quick and easy, the teacher can show them in class to motivate students or add them to another experiment during the laboratory work.

### 2.1.1 Isolation of Menthol and its Detection

Menthol is monoterpene (Structure 1) with nice smell, it occurs in nature in plant peppermint *Mentha piperita* [3]. It is added to food or cosmetics for its cooling effect. Menthol creates white or colorless crystals (Figure 1). Menthol aroma can be prepared by esterification of benzoic acid with ethanol in presence of sulphuric acid. Menthol can be used as secondary alcohol in esterification to give menthylesters which give floral aroma.

Procedure: Five candies containing menthol were fractionated between water and 1,2-dichloroethane. The dichloroethane fraction was used for free crystallization of menthol.

Detection of menthol by TLC: mobile phase: hexane/ethyl-acetate 2/1, detection by phosphomolybdic acid or 10% solution of sulfuric acid with heat. Retention factor  $R_f$  is 0.8.



Structure 1 Menthol



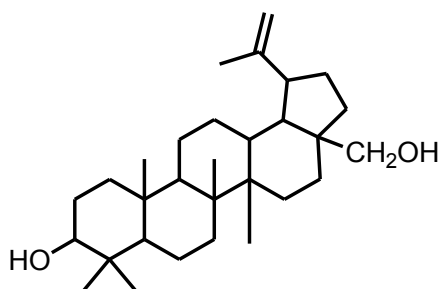
Figure 1 Crystals of menthol, source: author

### 2.1.2 Isolation of Betulin and its Detection

Betulin is triterpene (Structure 2), occurring in the birch bark (broad-leaved birch tree *Betula pendula*) which contain up to 30% of the dry weight of the extract. It creates white crystals (Figure 2). Betulin and its derivatives are used for biological activity (against a variety of tumors).

Procedure: 5 grams of birch bark was extracted by ethanol under reflux at 60°C for two hours. The ethanol extract was filtrated and evaporated under reduced pressure. The CC of the residue (mobile phase: hexane/ethyl-acetate 5/1 and solid phase: silica gel) afforded the pure betulin.

Detection of betulin by TLC: mobile phase: hexane/ethyl acetate 5/1, detection by phosphomolybdic acid or 10% solution of sulfuric acid with heat.  $R_f = 0.25$ .



Structure 2 Betulin



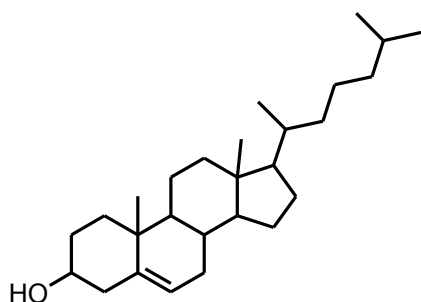
Figure 2 Crystals of betuline, source: author

### 2.1.3 Isolation of Cholesterol and its Detection

Cholesterol is steroid (Structure 3), which occurs in many foods. It can be isolated from egg yolk [4] and creates colorless crystals (Figure 3). It is famous for its unhealthy effect on human body.

Procedure: Two boiled egg yolks were extracted by acetone and 1,2-dichlorethan. The extract was filtrated and evaporated. The residue was fractioned by CC (hexane/diethylether 3/1, silica gel). The cholesterol was crystallized from one fraction.

Detection of cholesterol by TLC: mobile phase hexane/diethylether 3/1, detection by fosfomolybdenic acid or 10% solution of sulfuric acid with heat.  $R_f = 0.2$ .



Structure 3 Cholesterol

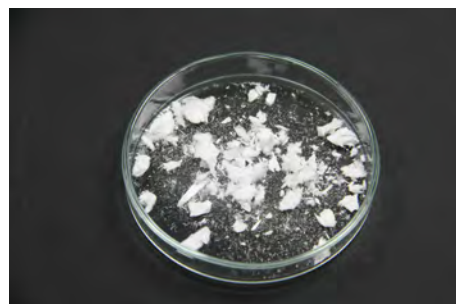


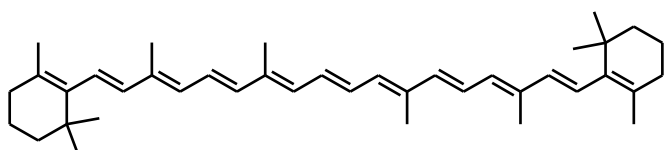
Figure 3 Crystals of cholesterol, source: author

### 2.1.4 Decolorize $\beta$ -carotene

$\beta$ -carotene is tetraterpene (Structure 4), it is red-orange pigment occurring in plants (fruits, vegetables, leaves). Its importance is as a precursor of vitamin A, it is added to sun cream for healthy skin and added to food for its colour (E160).

Procedure: The carrot was cut into small pieces and crushed. Chloroform was added to the carrot. The mixture was filtrated. Solution of potassium permanganate with sulfuric acid was added to a filtrate (2mL). The mixture was without colour (Figure 4) after five minutes.

The carrot obtains  $\beta$ -carotene which was oxidized by these reagents.



Structure 4  $\beta$ -carotene

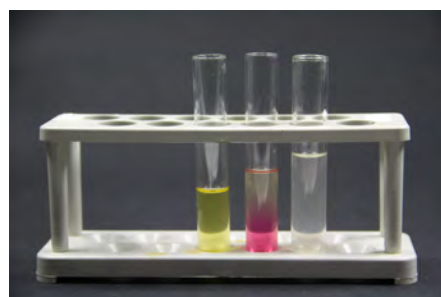


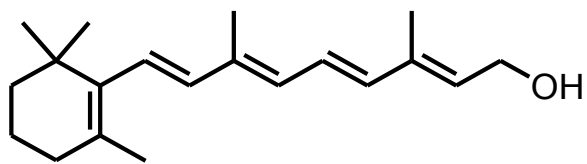
Figure 4 Decolorize  $\beta$ -carotene, source: author

### 2.1.5 The detection of vitamin A

Vitamin A is a diterpene (Structure 5) soluble in lipids and it is important for our eyes.

Procedure: Vitamin A (in the capsule) was proved under UV light, it fluoresced (Figure 5). It is distinctively different from vitamin C which cannot be proved under UV light.

Another experiment: Vitamin A reacted with antimony trichloride. After while it is going to be dark blue.



Structure 5 Vitamin A

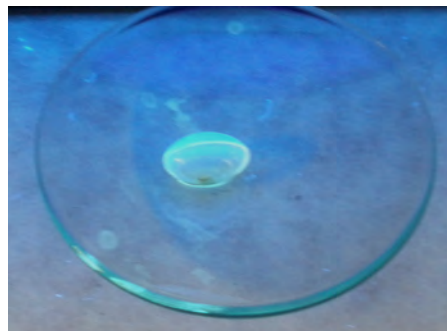


Figure 5 Vitamin A under UV light, source: author

### Acknowledgment

Supported by research project MSMT 0021620857.

### Reference list

- [1] Framework education programme for secondary general education, VÚP, Prague 2007
- [2] Marecek A., Honza J. Chemie pro čtyřletá gymnázia 3.díl. Olomouc 2005 (Marecek A., Honza J. Chemistry for High School 3, part. Olomouc 2005)
- [3] L. S. W. Pelter, A. Amico, N. Gordon, Ch. Martin, D. Sandifer, and M. W. Peter, J. Chem. Edu., 2008, 85 (1), 133
- [4] F. Douglass, Taber, Rui Li, M. A. Cory, J. Chem. Edu., 2011, 88 (11), 1580

## Thematic content and a draft proposal concerning the interdisciplinary implementation of the topic “municipal solid waste” into college class

**Charles Estay OSSANDÓN, Hans-Dieter BARKE**

*Faculty of Economy and Business Administration, University of Las Palmas de Gran Canaria, Spain*

*Institute for Chemistry Didactics, Fliednerstraße 21, 48149 Münster, Germany*

*E-mail: charles.estay101@doctorandos.ulpgc.es Phone: 0049-251-8339467 Fax: 0049-251-8338313*

### Abstract

The correct estimation of the accumulation of urban solid waste is an essential feature in the planning process of an efficient waste management system. Misjudgements have effect on the positioning as well as quantities of the supplied containers. This may lead to elevated costs and negative influences upon quality of life and environment. In order to limit this, the influencing factors of the urban solid waste arisings must be sufficiently known.

The first part of this paper examines the development of urban solid waste management in Europe, pointing out particular differences in quantities and treatment methods. That is, e.g. in 2010, each Danish citizen produced a mean of over 800 kg of waste per year, while this value decreases to a mere 300 kg in Poland. And concerning treatment methods, the nearly 100% landfill waste deposition applied in most eastern European countries stands in clear contrast to the fifty-fifty recycling and waste combustion methods implemented in countries like Germany, Switzerland and Austria.

To explain these differences, the second part of this paper takes a closer look at the different control parameters of waste accumulation. Those are mainly socio-economic and comprise, amongst others, the level of production, the gross domestic product, the level of education, the per-capita income and the consumer habits.

Due their growing global relevance, the topics „waste“ and „waste management“ should also be a subject in class. The third part of the paper accordingly outlines the structure of a possible teaching concept of these topics, whereas their multidisciplinaryity represents a special challenge. This is taken into account through the transversal incorporation of chemistry, geography, mathematics and economy class, amongst others, into the teaching concept.

**Keywords:** Municipal solid waste, waste production, waste management, waste treatment, interdisciplinary teaching concept.

### 1. Introduction

Due to the fast growing population and the tendency towards a society characterized by its consumer culture, the production rate of municipal solid waste (MSW) is increasing more and more and so does the global relevance of this topic.

This paper intends to explain the importance and the current situation of the subject “waste and waste management” on the one hand, and wants to give a suggestion for its implementation in college class on the other hand. A special challenge consists in the interdisciplinarity of the topic. This should be taken into account by the transversal incorporation into the classes of chemistry, physics, biology, geography and mathematics, as well as economical, political and social sciences (where applicable).

All numerical data concerning MSW in this paper is taken from [1].

### 2. Distribution of MSW generation

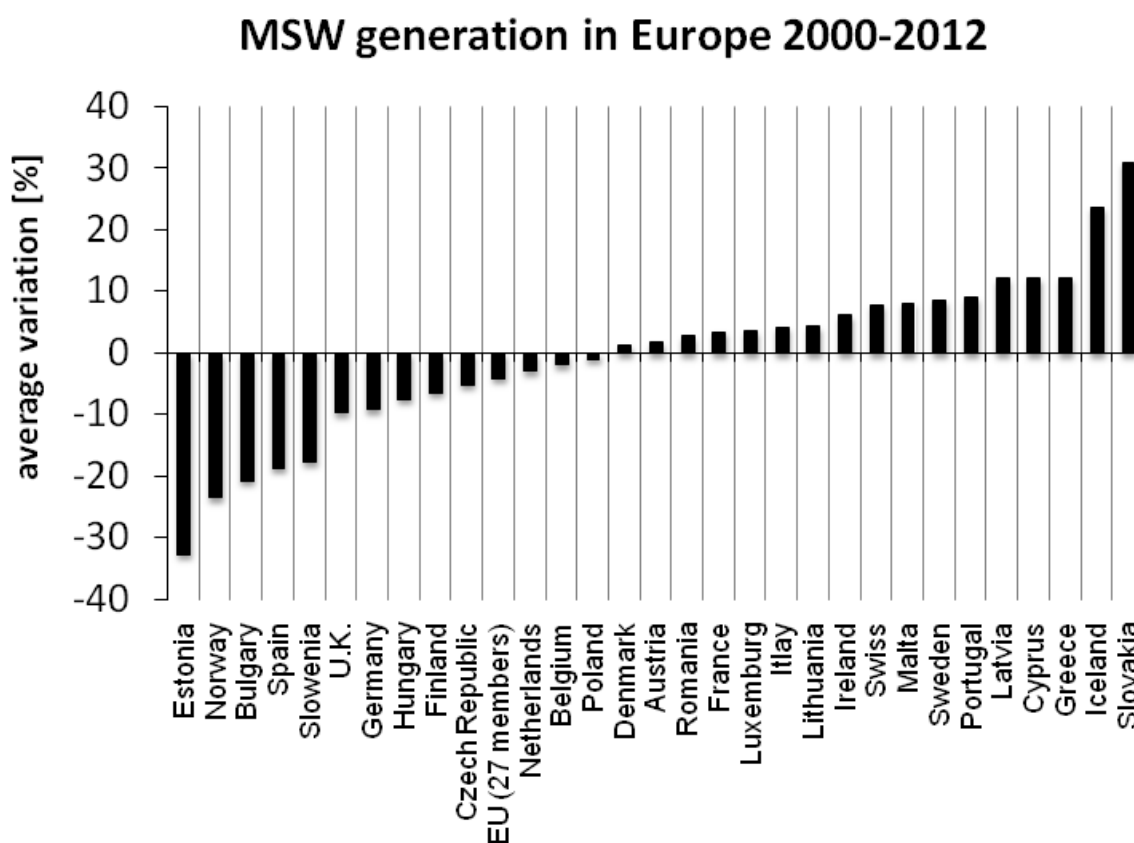
#### 2.1 Global MSW generation

Nowadays, the global population generates approximately 7 million tons of waste per day. If we biologically reduce and compact these wastes to their final volume, they can still fill an entire football sta-

dium per day. The waste production rate has grown more than twice as much as the global human pressure rate during the past 100 years. Reasons for this are the tendency towards consumption, the throw-away-mentality and the introduction of new materials and recipients. The latter are the consequence of a linear mode of both life and economy, both of which depend on consumer habits. Due to the ever changing consumer habits, it is still difficult to predict the quantity of generated MSW.

### 2.1 MSW generation in Europe

Figure 1 depicts the situation in Europe (EU-27) from 2000 to 2012, comparing the average variations in MSW generation per country. While the total EU mean shows a decrease of 4 %, the country means range from decreases of 20 to 30 % in the cases of Estonia, Norway and Bulgaria to increases of 10 to 31 % in the cases of Latvia, Cyprus, Greece, Iceland and Slovakia.



**Figure 1** Average variation rates of MSW generation in Europe between 2000 and 2012 (data taken from [1])

According to current calculations and predictions, in the year 2000 each European citizen produced an average quantity of 680 kg of MSW.

The total annual MSW amount of Europe would serve to cover the entire surface of the isle of Malta with a layer of a thickness of 2,5 m (once compacted, the MSW have a maximum density of 550 to 700 kg per m<sup>3</sup>). The growing tendency in MSW generation is just a direct consequence of a socio-economic model according to the necessities connected with the different consumer habits selected by ourselves.

### 2.2 MSW generation of industrialized vs. developing countries

Normally, the composition of MSW depends on the capacity of consumption (that is, consumption habits) of the population of the respective country. Table 1 compares the MSW composition of industrialized and developing countries.

**Table 1** Average MSW composition in industrialized and developing countries (data taken from [1])

Material	Industrialized Countries	Developing Countries
Metal	4 - 8 %	1 - 2 %
Glass	6 - 17 %	1 - 4 %
Sand & Ashes	0 - 5 %	6 - 16 %
Paper	14 - 32 %	3 - 5 %
Carton	5 - 10 %	1 - 5 %
Wood	0 - 1 %	0 - 1 %
Plastics	10 - 16 %	4 - 7 %
Rubber & leather	0 - 1 %	0 - 1 %
Textiles	3 - 6 %	2 - 4 %
Organics	40 - 55 %	58 - 80 %

It is evident that the more developed a country, the larger its tendency towards consumption of goods and services. In this way, developed countries produce less organic waste and more synthetic trash, such as plastics, glass and metals. The same tendency can be found comparing large cities and rural surrounding areas.

This allows the affirmation that the MSW generation is directly related to economical, social and cultural factors. The analysis of the MSW composition is therefore a useful index of the social reality of a country, its cities and the characteristics of its inhabitants.

### 3. Estimation and modelling of MSW generation

The knowledge of the origins and types of MSW, in addition to data on its composition and generation rates, as well as factors like the current and future population are the basis for the planning and design of facilities and operational systems, which in turn are associated with an optimal management of MSW.

In order to estimate the time vector of the MSW development in a city, it is necessary to get to know both the factors that control its per capita production and composition, and the socio-economic factors, including cultural consumption habits, indicators of human development and other indicators, such as political constraints, laws and public attitudes. Furthermore, there are geographic factors, such as population growth and type of climate, and other factors, such as lifestyle, the development status of the area and seasonal variations.

#### 3.1 Mass-Balance-Analysis

For decades, experts have attempted to estimate the generation of MSW through methods like the number-of-loads-analysis, the weight-volume-analysis or the mass-balance-analysis (MBA), whereas the latter is the most commonly used and has the highest reliability level in the estimation, because it incorporates mathematical relationships.

The mathematical equation of the MBA is:

$$\frac{d_{MSW}}{dt} = \sum MSW_{in} + \sum MSW_{out} \quad (\text{Eq. 1})$$

$\frac{d_{MSW}}{dt}$

is the alteration rate of the weight [kg] of the accumulated MSW material within the study unit per time [day]

$\sum MSW_{in}$  is the sum of all the MSW material that enters the study unit [kg/day]

$\sum MSW_{out}$  is the sum of all the MSW material that leaves the study unit [kg/day]

$r_c$  represents the total of the so-called confounding factors

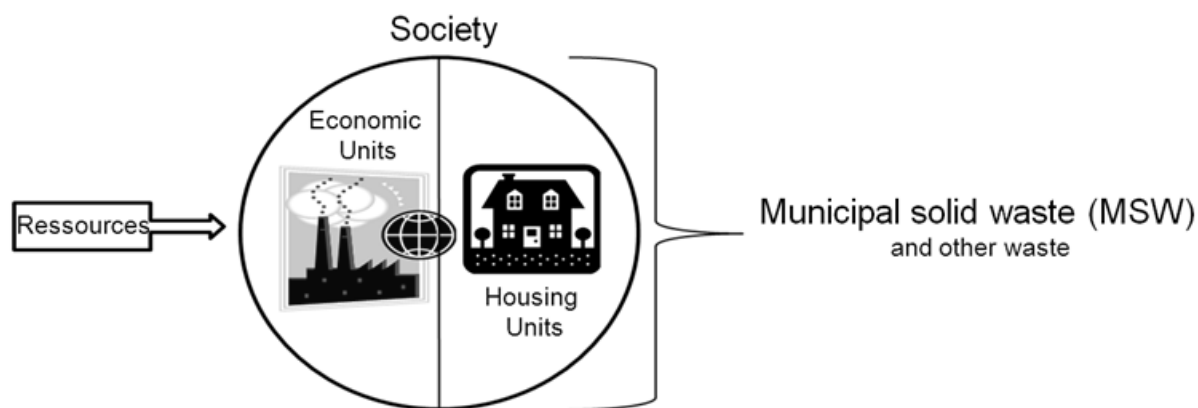
The problem: These measured rates hardly reflect the true rates, because the confounding factors ( $r_c$ ),



such as in-situ-storage and the use of alternative evacuation sites (typical deviation), are very hard to estimate.

### 3.2 An option: Relationship society - environment

The proposed hypothesis of the present study is that it is possible to reliably estimate the generation index of MSW ( $GI_{MSW}$ ) in a community, considering its division into two involved agents. These agents are: Housing units (HU) and economic units (EU). The basic premise is that the agents (or factors) HU and EU are interacting within the same system. Thus, this system comprises the relationship between society and environment.



**Figure 2** Relationship between resources, society and MSW

One can relate the MSW generated by each source (HU and EU) by assigning them the variables  $MSW_{HU}$  and  $MSW_{EU}$  respectively. The sum of both variables represents the total MSW generated. In turn, the MSW generated by the housing and economic units are directly related to the so-called generational indexes (GI) through the acronyms  $GI_{HU}$  and  $GI_{EU}$  respectively, which on their part are controlled by the own subsystems (HU and EU).

In other words: Each subsystem (HU and EU) has its own generational index ( $GI_{HU}$  and  $GI_{EU}$ ). These indexes depend on their own properties and/or associated variables. The  $GI_{EU}$  relates to the amount of MSW related to the number of companies, employees, gross production and gross domestic product amongst others, and the  $GI_{HU}$  does the same with variables such as number of inhabitants, level of education and level of income per capita, etc..

To simplify this, the following mathematical equation can be observed:

$$G_{MSW} = MSW_{GI_{HU}} + MSW_{GI_{EU}} \quad (\text{Eq. 2})$$

Where

$$MSW_{GI_{HU}} = GI_{HU} * HU$$

$$MSW_{GI_{EU}} = GI_{EU} * EU$$

That is

$$G_{MSW} = f(GI_{HU} * HU + GI_{EU} * EU) \quad (\text{Eq. 3})$$

This is a way to get closer to estimate the generation rate of MSW based on the available information. In order to increase the reliability of the estimate, other properties or variables can be included into the equation. As the  $GI_{HU}$  and the  $GI_{EU}$  depend each on their own operators, the terms of the mathematic

model can be rearranged in the following manner:

$$GI_{HU} = b_{edu} \frac{edu}{HU} + b_{inc} \frac{inc}{HU} + \dots + b_n \frac{n}{HU} ; \quad GI_{EU} = b_{emp} \frac{emp}{EU} + b_{prd} \frac{prd}{EU} + \dots + b_n \frac{n}{EU}$$

(Eq. 4) (Eq. 5)

with:  $GI$  = MSW generation index  $b$  = weighting coefficient  
 $edu$  = level of education  $inc$  = level of income  
 $emp$  = number of employees  $prd$  = gross production

Then the equation for the estimate would be given by:

$$G_{MSW} = \left( b_{edu} \frac{edu}{HU} + b_{inc} \frac{inc}{HU} + \dots + b_n \frac{n}{HU} \right) * HU + \left( b_{emp} \frac{emp}{EU} + b_{prd} \frac{prd}{EU} + \dots + b_n \frac{n}{EU} \right) * EU \quad (\text{Eq. 6})$$

The terms and variables associated with each index depend on the information collected on the study area. This equation can be extrapolated to other communities and determine, with a certain degree of reliability, their generation of MSW without knowing other statistical data.

### 3.3 Verification methodology

In order to verify the abovementioned equations, socio-economic statistics of the year 2009, as well as data on MSW generation until the year 2000 and projections up to 2015 from a Spanish community with 21 municipalities were used. The contrast for the verification of the hypothesis was done with a data sample of 5 of the mentioned municipalities in the year 2010. The applied variables include: socio-economic type, structural and internal waste management, level of employment, level of education, consumer habits, market share, number of tourists, index of tourism, commercial rate, industrial index, housing units and economic units amongst others.

The results of the statistical tests indicate the validation and verification of the hypothesis. The reliability of the abovementioned equations shows a high statistical significance (sig 90 %), which means that it is possible to generate a mathematic model with the variables that influence and explain the generation of MSW in a community and thus it is possible to optimize the waste management planning via statistical evaluation.

## 4. From the educational point of view: Education as a management tool

### 4.1 Subject area “municipal solid waste”

The interdisciplinarity of environmental topics requires the interaction of miscellaneous disciplines and institutions. From the educational point of view, it is beneficial that the MSW topic represents a day-to-day issue affecting the entire humanity. A detailed comprehension of this matter promotes a positive attitude towards environmental protection. This justifies the incorporation of the MSW topic into different school subjects, such as e.g. chemistry, physics, biology, geography and mathematics, as well as economical, political and social sciences.

Nowadays, the MSW topic is not only of an engineer character, but also incorporates more and more research facilities specialized in other areas.

### 4.2 A cross-curricular teaching concept

Due its growing global relevance, the topic „municipal solid waste“ should be treated in college class. As MSW has multidisciplinary aspects, a possible teaching concept should be cross-curricular, that is, it should transversally incorporate both natural, political, economical and social sciences. Potential contents of the concept for each subject may be as follows:

- Chemistry: Chemical characteristics of the different MSW fractions; effects of toxic compounds; recycling and waste combustion
- Physics: Physical properties of the different MSW fractions; waste treatment plants
- Biology: Organic MSW cycle; determination of the influence of MSW on the ecosystem
- Geography: Design of an efficient MSW management system (itineraries, containers, etc.)
- Mathematics: Estimation of daily MSW generation rates (see chapter 3); determination of optimal itineraries
- Political Sciences: MSW legislation - global comparison, possibilities and constraints
- Economical Sciences: Cost optimization in treatment and management of MSW
- Social Sciences: Analysis of consumer habits; throwaway society

### **Conclusion**

Although the interdisciplinarity of the MSW topic is a challenge for education, it also entails the opportunity to increase the interest in the thematic interrelations and thereby promote a positive attitude towards environmental protection. Furthermore, the rising global relevance of this topic makes it almost obligatory to transmit it in class. It has to be taken in mind that the activation and education of the young generation is a vital step towards a sustainable future.

### **Reference list**

[1] European Commission: Eurostat Data Base, 2010 Waste Statistics.  
[http://epp.eurostat.ec.europa.eu/statistics\\_explained/index.php/Waste\\_statistics](http://epp.eurostat.ec.europa.eu/statistics_explained/index.php/Waste_statistics). Accessed 15 June 2012

## The Diamonds of Lavoisier in the teaching of the concept of combustion in Low-Secondary Education

Fátima PAIXÃO

*Research Centre of Didactics and Technology in the Education of Trainers, University of Aveiro, Aveiro, Portugal  
and Polytechnic Institute of Castelo Branco, Castelo Branco, Portugal.  
Escola Superior de Educação, Instituto Politécnico de Castelo Branco.  
Rua Faria Vasconcelos, 6000-266 Castelo Branco, Portugal  
E-mail: mfpaixao@ipcb.pt Teleph: +351 272 339100; Fax: +351 272 343497*

### Abstract

*Various answers have been given when questioned why the history of science should be an important part of the education in chemistry. Two of the aspects we want to highlight here and which are goals of education in chemistry are: To promote better and more complete understanding of scientific concepts giving an account of their construction and development; to increase the interest and motivation in learning chemistry.*

*With this study we have as central objective to show that the original sources of the history of science are a valuable resource for achieving such goals in chemistry teaching.*

*The Lavoisier's Elementary Treatise of Chemistry is a work which, by its emphasis on the construction of the theory of the New Chemistry, has been translated into many languages, establishing itself as a precious educational resource. It is known that Lavoisier was a man with a multidisciplinary vision and formation and also very rich and powerful and that a great amount of his fortune was devoted to the development of chemistry. Using an experimental approach and excerpts from his texts and also from the texts of the Portuguese earlier supporter of his theory, Vicente Coelho de Seabra, we present a teaching strategy to the low secondary education for teaching the concept of combustion.*

*Beyond the texts and the experimental situations, the strategy includes as motivation, reading the part of the text of Lavoisier on the combustion of diamonds.*

**Keywords:** Education in Chemistry; Secondary Education; History of Chemistry; Combustion; Lavoisier; Vicente Coelho de Seabra.

### Introduction

Scientific ideas have a history and sometimes many associated stories. The history of science helps us to better understand the science, the scientific knowledge, scientists and also our society that is immersed in science and technology, and that these three components are, and have been in the past, closely related [1-2]. The model is an equilateral triangle representing the history of scientific ideas and in each vertices science, society and technology, showing that this three aspects are equidistant and are the pillars for the understanding, in the past as well as in the present, of the scientific ideas and of the construction of a more realistic and desirable History of Science [3].

Several researchers have reflected on the relevance of the use of the history of science in science education being its importance well recognized [4-7]. One of the valued aspects is their own use as a way of presenting science as a human activity with strong cultural and social meaning, allowing a deeper understanding of the nature of science and scientific knowledge and of the work of scientists and scientific communities. Also the study of scientific ideas in their context of discovery helps to develop students' conceptual understanding [8-9].

Various answers have been given when questioned why the history of science should be an important part of the education in chemistry [10-11]. Two of the aspects we want to highlight and which are goals of education in chemistry are: To promote better and more complete understanding of scientific concepts giving an account of their construction and development; to increase the interest and motivation in learning chemistry [12-13].

With this study we had as central goal to show that the original sources of the history of science are valuable resources for achieving such goals in chemistry teaching.

The Lavoisier's *Elementary Treatise of Chemistry* is a work which, by its emphasis on the construction of the theory of the New Chemistry, has been translated into many languages, establishing itself as a precious pedagogical resource. It is well known that Lavoisier was a man with a multidisciplinary vision and formation and also very rich and powerful and that a great amount of his fortune was devoted to the development of chemistry.

The concept of combustion is directly associated with the principle of mass conservation and its scientific understanding is associated to the construction of the New Chemistry in the 18<sup>th</sup> century. This is not an easy concept to the students despite many secondary teachers do not admit it [14]. The idea of conservation is acquired near 11/12 years. However, the students must be confronted with specific situations.

Using an experimental approach and excerpts from the texts of Lavoisier [15], directly or from the texts of his contemporaneous, the Portuguese Vicente Coelho de Seabra [16], we developed a strategy to the low secondary education for the teaching of the combustion.

Beyond the texts and the specific experimental situations, the teaching strategy includes as motivation, reading part of the texts of Lavoisier and of Coelho de Seabra concerning the combustion in general and the combustion of diamonds.

The teaching strategy we present here is part of a greater teaching proposal centred in the use of historical experiments and several fragments of historical texts [10,16]. However, we tried to organize and use in the teaching of chemistry in low secondary education some coherent aspects reorganized from the initial proposal, offering to the teachers the possibility of introduce little pieces of the history of chemistry for relevant subjects without deeply change their whole and usual teaching. This way used in in-service teacher education programs highlights for the more septic teachers the relevance of the history of science in the teaching of chemistry.

The main aim of this study was to emphasize that the original fonts of the history of science are rich pedagogical resources for teaching the concept of combustion in low secondary education in chemistry teaching.

### **Teaching the concept of combustion**

The proposed strategy was designed for two lessons (two hours) for the low secondary education (13-14 years old students).

The development of the strategy implies three articulated phases and it had the following curricular objectives: (1) Identify the difficulties of the phlogiston theory to explain the combustion reactions and recognize the need for a new theory to guide the experience; (2) Understand the concept of combustion under the principle of mass conservation in chemical reactions; and (3) Recognize that the history of chemistry helps to understand the construction of the scientific knowledge.

The starting point centres in some questions functioning as contextualization, like: What we think that happens to the mass of a piece of wood when it burns? What we think that happens to the mass of a piece of steel wood when it burns?...

The teacher and students register the answers as previous ideas about the subject. Subsequently, the students read a constructed text about the Sthal's theory of the phlogiston. We prepared a document entitled "A theory for interpreting the chemical reactions of combustion"<sup>16</sup> with some final questions helping students to organize the principles of this theory. Some students could change their initial ideas about the behaviour of substances and corresponding mass change in combustions, now supported by a theory that had the phlogiston as a principle of combustibility disappearing when the material burns, conducting to a mass increasing after the combustion.

The second part of the strategy initiate by the explicit question in order to develop experimental tests: when a material burns (combustion reaction) the mass (amount of matter determined by the balance) maintains, increase or decrease? The experimental test includes the combustion on a balance of three ma-

materials: ethanol; cotton wool and steel wool (iron). Prior to the combustions, students predict the result in each concrete situation, if mass increase, remains or decrease, and register their predictions.

In group, under the surveillance of the teacher, students carry out each combustion on the balance, registering the mass in each case, before and after the combustion, comparing and confronting the results with the predictions and interpreting the differences between the three different situations. The ethanol is a liquid and it has a behaviour similar to the cotton (the mass decreases, because both are hydrocarbon compounds) which is a solid like the iron (whose mass increase because it is a metal).

After the tentative interpretation of the experimental situations under the light of Sthal's theory of the phlogiston, students feel the need of a new and different theory which involves the role of the oxygen of the air and they arrive to the concept of combustion under the theoretical principle of mass conservation.

The third phase of the proposed strategy considers the historical way made by Lavoisier and their collaborators and supporters, among them was his wife, Marie-Anne Paultze. This part helps the students to understand and consolidate the concept of combustion. The *Elementary Treatise of Chemistry* by Lavoisier (1789) as well as the *Elements of Chemistry* by the Portuguese Vicente Coelho de Seabra (1788) helps the students to understand the construction of the theory of the new chemistry (theory of the oxygen) with excellent and explicit historical excerpts.

In the laboratory of Lavoisier lots of materials were burned, among them the famous diamonds. Only the richness of the French chemist permitted to make the great amount of experiences made with sophisticated technology including the use of diamonds as well as other precious gems.

This last aspect was associated to the strategy after the experimental tests and discussion about the idea of mass conservation and of the concept of combustion, for the consolidation of these concepts and at the same time for learning about chemistry and its construction, through the history of science.

In the former Library of the University of Coimbra there are the book with the works of Lavoisier [15] which first tome includes the *Elementary Treatise of Chemistry*, yet referred. In the same Library there are also the *Elements of Chemistry*, published one year before the publication of the *Treatise*, by the Vicente Coelho de Seabra [16], an immediate and acutely supporter of the new theory. Both books consider the principle of mass conservation and explain the idea of combustion. This concept was given by Lavoisier as *combustion is the combination of oxygen with the bodies* and he considered that *the class of combustibles bodies is very extensive and among these bodies there are some of them that burn rapidly with a shining bright flame as the oils, sticks, resins, &c. other without sensitive flames, like many metals. (...) The burned bodies after the combustion become non-combustible and the limes of metals weight more than before they were burned and this gained weight is equal to the weight of the combined air* [16]. The end of the third phase of the teaching strategy includes questions like the followings: Do you think that a diamond can burn? And what do you think that happens to the mass of a piece of diamond when it burns?

In the words of Lavoisier, *in respect of the diamond, it has a property which is very special; that of burning like fuels and dissipate entirely.*

Vicente Coelho de Seabra also wrote about the diamonds, despite he did not make the experiments but referring the French chemists: *after the experiments of Macquer, Cadet, Lavoisier and others, it is known that it is a combustible substance and it burns with the air, making red. We do not know until now what its residue, but whatever is, it is not fixed and in a certain portion of air appears a certain amount of carbonaceous acid, according to Lavoisier* [16].

### Final remarks

As concluding remarks we can note that some in-service teachers who never accepted to adopt the large strategy referred above about mass conservation and combustion reactions saying that it was very exigent and that it consumed lots of time, adopted this proposal. They recognized its great value in the motivation of the students and in the consolidation of the learning of the principle of mass conservation and of the concept of combustion. The teachers highlighted the pedagogical relevance of the conjugation of the experimental approach with the history of chemistry. In their opinions, a very positive aspect was the use

of original fonts, the texts of Lavoisier and the texts of Vicente Coelho de Seabra existing in the well known university of Coimbra.

Effectively, chemistry is an experimental science and this character should be used in teaching. At the same time with the use of the history of chemistry students can build a better picture of chemistry and how its knowledge was being built.

## References

1. S.Y. Kim, K.E. Irving, *Science & Education*, **2010**, 19, 187-215.
2. R. T. Cross, *Australian Science Teachers Journal*, **1990**, 36, 33-38.
3. M. P. Clough, *Science & Education*, **2011**, 20, 701-717.
4. R. L. Coelho, *Science & Education*, **2010**, 19, 91-113.
5. D. Gil-Pérez, *Enseñanza de las Ciencias*, **1993**, 11, 197-212.
6. M. R. Matthews, *Science & Education*, **1992**, 1: 11-47.
7. F. Paixão, *História da Ciência na Educação em Ciência*, IPCB, Castelo Branco **2011**.
8. H. E. B. Viana, P. A. Porto, *Science & Education*, **2010**, 19, 75-90.
9. M. Monk, J. Osborne, *Science Education*, **1997**, 81, 405-423.
10. A. F. Cachapuz, M. F. Paixão, *School Science Review*, **2005**, 86, 91-94.
11. T. Sprod, *The Australian Science Teachers Journal*, **1993**, 39, 14-20.
12. S. Y. Kim, K. E. Irving, *Science & Education*, **2010**, 19, 187-215.
13. M. Matthews, *Science & Education*, **1992**, 1, 11-47.
14. F. Paixão, A. Cachapuz, *Química Nova na Escola*, 2003, 18, 31-36.
15. A. L. Lavoisier, *Ouvres de Lavoisier*, Imprimerie Impériale, Paris **1864**.
16. V. Coelho de Seabra, *Elementos de Chimica*, Real Oficina da Universidade, Coimbra **1788**.

## The colours of chemistry: There's a new scent in the air, or old perchance?

Sergio PALAZZI

ISIS di Setificio "Paolo Carcano", via Castelnuovo 3, 22100 Como  
E-mail: sergio@kemia.it

### Abstract

*Chemical competence and awareness are not only scientific but also ethical topics. To fight chemophobia and have young people involved in chemistry courses, chemistry teachers and communicators should think not only about new techniques or devices, but also at the inner structure of their syllabi. On the ground of concrete experiences some hints are given, to link the topics we usually teach to tailored experimental work on colour and fibre chemistry. It is suggested to reboot the teaching approaches, rediscovering some ideas from the early dawn of modern applied chemistry.*

**Keywords:** Colour; dyeing; experimental teaching; chemophobia.

We all know it: chemistry is boring, dangerous, difficult, cold, useless. Everybody says it, writes it, shows it everywhere. We have been talking about it all along 2011 IYC. We even invented the word *chemophobia*.

Of course, to change this opinion, as chemistry teachers we know we have to change something in our way to communicate chemistry. To show people that sciences in general, and chemistry in the first place, are of foremost relevance even for a free democracy in which aware people are free to choose, and in the largest sense for human growth - as we have heard for instance in the passionate lecture by Bassam Shakashiri [1].

The discussion is very often about new tools which can be useful to teach and to motivate young and not-so-young people. Many are suggesting, for instance, a massive introduction of a lot of new technological supports, interactive whiteboards, tablet PCs, dedicated software and so on, at the risk of putting into new containers just the same old stuff, that has lost any flavour.

Less reflection is concerning *which kind* of chemistry we teach, and why.

*Could we start again, please?* We can imagine to reboot our teaching procedures, as if we were pressing some *Ctrl-alt-del*, and loading a previous release of our operating system, taken from an age in which chemistry was fresh and appealing. Maybe a *colourful* chemistry.

Let's go back to about the mid of 19<sup>th</sup> century.

It was the moment in which a young man like "Stan" Cannizzaro had been redefining the perspectives of chemistry, as he was thinking about how to define a new chemistry programme [2]. So, changing a teaching habit had been an important trigger to start a new scientific thought.

More or less at the same time, a boy, the just 18-year-old "Billy" Perkin, was discovering the new fundamental technology of synthetic dyestuffs, because of his ability to find something new where another would have seen only rubbish. And, as we know, he was first interested in the industrial transfer of a new business, and *only later* did he turn back to academic research, to become the white-bearded and honoured Sir William Perkin in his later pictures.

At that time, young people were thrilled by the magic of chemistry, which was the newest and more hi-tech fashionable topic. It *smelled like progress*.

In most advanced countries, many schools were established to teach the new technologies, to sustain several growing industrial sectors which were improving the quality of life for millions. Among them, the Technical School for Silk Technologies "Paolo Carcano" of Como, the *Setificio*, where I once studied and where now I'm proud to teach. Until now, a core component of the "Como silk district". Those schools mostly had their own, peculiar curricula.



So, I'm trying to show how the format of a chemistry course can be redesigned thinking of colour and dyeing technology, or in a wider sense of fibre and textile finishing.

We have to think that this is maybe the oldest sector of industrial production which is still performing more or less the same activities after thousands of years, to achieve more or less the same aims. Still pervasive in any society, after the innovations that were introduced by the chemical revolution which started in the second half of 19<sup>th</sup> century, from the enthusiastic work of those pioneers.

In every age it has been boosting researches, whose fallout has enriched every sector of human society, although common audience could hardly see them, just like most mainframe programmers around 1980 did not know that their perforated cardboards-operated computers were close relatives of the Jacquard loom (ca. 1800).

Theoretical principles and working methods from the science of colour and dyeing are at the base of an incredible number of unexpected and growing sectors. They are backing imaging technology, DVDs, drug delivery, lasers, artificial photosynthesis, microelectronics, food packaging, surfactants, conductive polymers, functional coatings, and so many other amazing things of our age.

Students in our classes may be shaken from their slumbers, if we show them that we are speaking of so many things which they feel relevant for their identities and lifestyle, including sweatshirts, sneakers, trousers, but also skin, nail and hair cosmetics (yes, unfortunately also synthetic drugs, but you can't have it all).

Why should we think they are not interested in such a chemistry, if along our lessons they have clear that we're dealing with this, and not with alien oddities? We could use this old but still new approach to teach them in a more attractive way. Of course not forgetting what happened in so many decades: we are supposed to have plenty of materials and ideas to start from, to be at least *creative* like those guys in 19<sup>th</sup> century.

And colour itself is so attractive, so pervasive. We are an uncommon kind of mammals, more relying on vision than on any other sense, and we use colours as a real or symbolic communication code in any sector of our life. Even if we think that during the present conference we mourned a hero of our youth, the *deep purple* Jon Lord.

But, after all, colour is in most cases quite a typical chemical phenomenon: of the classical "15 causes of colours" outlined by Kurt Nassau [3], 11 are of chemical origin, although in most undergraduate teaching programmes we are speaking just about the interaction of light with delocalized organic  $\pi$  systems, and maybe about d-d transition and some charge-transfer adducts.

Recently I found it really intriguing that to celebrate the career of Harry Gray, one of the greatest chemists of our days, some of his students decided to characterize every field of his incredibly wide research with the *colour* associated with certain light-interacting chemical group he had been studying [4].

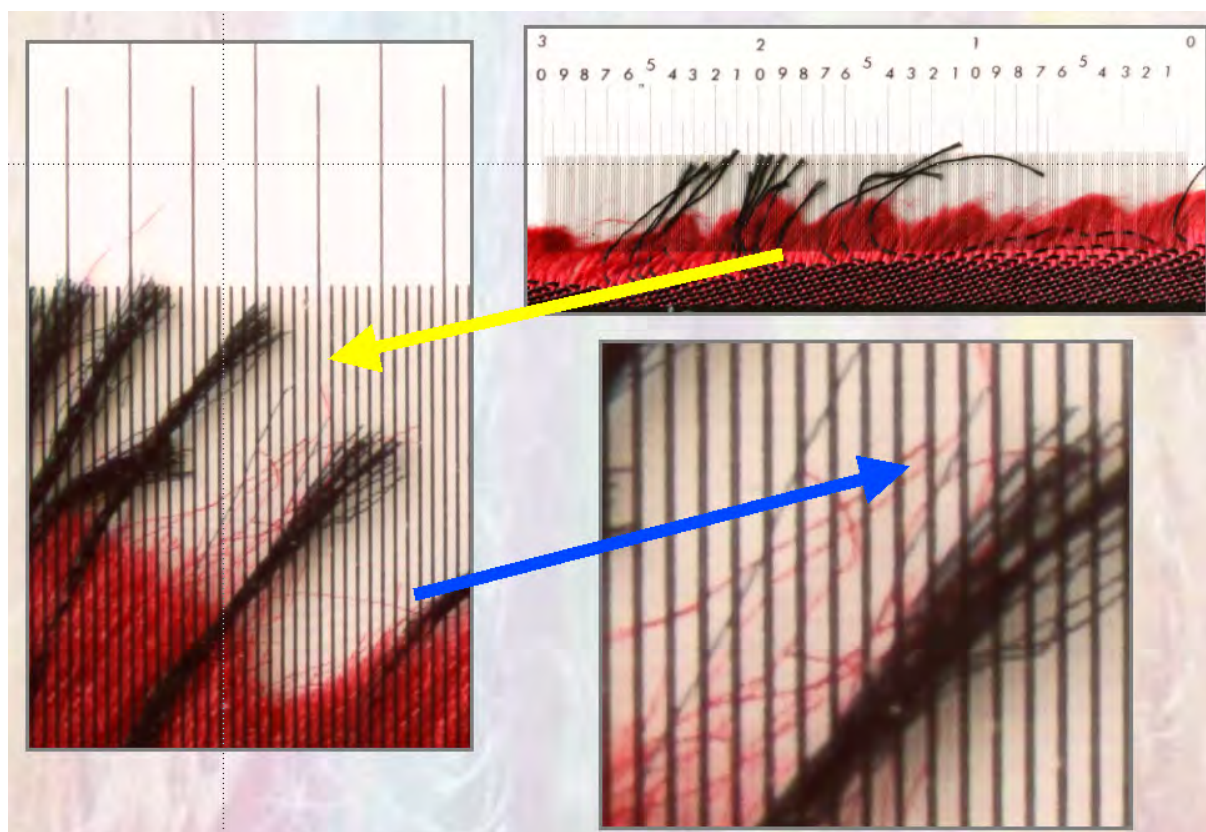
On the other side, textile products are made of fibres, and also thinking to fibres as *materials* we can find so many hints to teach chemistry in a fascinating way.

We could think, indeed, that materials science *and* chromatic models were *both* pioneered by Thomas Young, when scientific overspecialisation had not yet narrowed our sight.

As Kristen Murphy has shown in her lecture [5], one of the more relevant issues to a good understanding of chemistry is the ability to have a perception of the scale of objects, zooming from the macro to the micro. In my experience, a correct use of SI formalisms is a powerful tool to help this understanding.

But coping with the scale of objects is exactly the way that fabrics, fibres, macromolecules inside them, and their interaction with microscopic and macroscopic systems, have been taught for at least half a century. Even the famous exploded graph of the most complex fibre, wool, is a common picture since the early '70s [6].

If a certain fibre is 15  $\mu\text{m}$  wide, and you can hardly observe it without a lens, you have to think that its single molecules must be really thinner, although their length may reach the level of visible objects, and that a dyestuff molecule has to be three or four orders of magnitude smaller of the fibre's width, to move freely inside its amorphous regions.



**Figure 1:** Zooming from macro to micro: opportunities given by fibre material

The supramolecular approach to complex system and material science appeared rather straightforward to junior students of textile chemistry, well before that same word, *supramolecular*, was invented!

Along two decades, I have been observing that a *colourful approach* is very useful to teach chemistry at any level [7], and now I even believe that it could be possible to sketch a brand new syllabus for *every* chemistry course, from elementary to at least undergraduate level, taking most of the examples from fibre dyeing and finishing chemistry.

We can include general, organic, inorganic, analytical and physical chemistry; from stoichiometry to reaction mechanisms and to material characterisation, but also ethics, health, environment, sustainability (if I had said twenty years ago that the more promising and sustainable fibres for the future were the cellulosic artificial ones, I would have expected most people to laugh at me; now it is precisely what I think, because of *then* unforeseeable improvements in technologies).

In recent years, at the “Setificio” we have been performing workshops for kids of middle school, in which our slightly older students are introducing *The Colours of Chemistry*.

In a hands-on, peer-education context, they show how to extract the colour of vegetables with the oily and the acidic aqueous phase of a salad dressing; to perform flame tests and discover the way they are used in forensic analysis; to selectively dye or stain different fibres with plant colours or with the synthetic indigo of their jeans, and so on.

It is worth noting that more than 80% of those visiting boys and girls subsequently decided to study chemistry by us, with a clear motivation improvement of our classes.

A huge and exciting experience has derived from the chance I had this year, teaching chemistry at a 5<sup>th</sup> class of weaving designers, two 4<sup>th</sup> classes of dyeing chemists and a 2<sup>nd</sup> class of beginners. They alternated in performing laboratory experiments, in which the same works about fibres and colours were used to show topics that are, at first sight, completely different: solution stoichiometry, acid/base and

redox equilibria, colorimetry, kinetics, material science, data processing and so on.

Every experience was always intended primarily for theoretical teaching, rather than for practical training, and the lab has always been the main teaching space, according to a sound tradition that has been so deeply explored and enhanced in recent years by Brian Coppola [8-10].

One sub-project included in this work was called *Melting Colours*.

The 2<sup>nd</sup> year students were involved in a two-year-Comenius experience, having inter-exchanges with schools from Andalusia, Alsace and Poland.

Having to receive their Alsatian friends, they asked their senior colleagues to weave a Jacquard fabric showing a “postcard from Como”, made of a white PET warp and white rayon weft. Dyeing the white fabric at 130°C in an automatic test machine, with a mixed liquor containing selected disperse and/or direct dyestuffs, it is possible to obtain two completely different colours on the fibres, making the photographic elaboration of the weaving visible.



**Figure 2:** Differential dyeing: why materials behave differently in the same chemical environment?

After having worked for more than two months at the whole design of the workshop day, including not only preparative chemistry, logistic and written instructions, but also theatrical aspects, the students asked their guests - teachers included - to choose the couple of shades that everyone desired for his or her own “postcard”, then to compose their own “colour menu” like at a self-service restaurant, and then to operate the machines and look at their results.

For our students, it meant using and improving their knowledge about the majority of their programme for the 1<sup>st</sup> and 2<sup>nd</sup> year, in an unexpected and surely not too boring way.

Meanwhile, the weavers of the 5<sup>th</sup> class used these experiences to work at their own materials, weaved in PET and silk, in order to prepare their final state exams (by the way, they got very good grades!).

So, what can we learn from these examples?

Most of us are complaining about our syllabi, which have been more or less always the same for decades; about our textbooks, so often stereotyped from older and older books; and about the trouble we have to reach our present day students.

If we perform that *Ctrl-alt-del* on our minds, on our programmes, on our textbooks, we can find new inspirations (also) looking at our past.

Chemistry is fun, easy, reasonable, rich, amazing, exciting and *alive*. We can show it under a new light if we try to change our perspectives from what is being done all around us.

From the lessons we had by our teachers, we should not reproduce the sequence of words or reactions they wrote on the blackboard in some past time, but their human experience in the flow of knowledge.

I'm not saying, of course, that every teacher has now to follow this thread and change his or her teaching, in order to speak only about colours and fibres, but exactly the opposite: *if it is possible* to follow such a thread to renovate our teaching habits, it means that *a lot of different threads* may guide *my own* lessons with *these* students that *now* I have in front of me.

Any class is living in *its own* peculiar context, has *its own* experiences and expectations, is working for *its own* personal and professional future. It would be absolutely surprising that a programme written twenty or sixty years ago for a completely different context could be satisfactory for *this* class, *now*.

Don't forget the sentence by Max Planck autobiography, and try to behave consequently:

*Eine neue wissenschaftliche Wahrheit pflegt sich nicht in der Weise durchzusetzen, daß ihre Gegner überzeugt werden und sich als belehrt erklären, sondern vielmehr dadurch, daß ihre Gegner allmählich aussterben und daß die heranwachsende Generation von vornherein mit der Wahrheit vertraut geworden ist.*

Or: *A new scientific truth does not triumph by convincing its opponents and making them see the light, but rather because its opponents eventually die, and a new generation grows up that is familiar with it* [11].

After all, most of us feel very young, and really don't like the idea to be a species awaiting for our own extinction: let's discover some new ecological niches in which our specialisation can make us a winning competitor, and *evolve*.

This requires a strong sensitivity, to understand what kind of future is open in front of the students we are working *with* and *for*. Let's put some colour in our and their chemistry.

One last remark: *dyeing* chemistry schools, in Italy, are *dying* schools. Even the oldest and most renowned.

The current trend is to cut away specialized courses that have grown from very long traditions, in peculiar social and economical contexts, which are the heritage of our country's creativity. We are facing a homologation process that is likely to lead to a further decay of our future citizens' chemistry knowledge and awareness. It is just the case to observe, although it seems hard to believe, that in force of current laws the large majority of our high school students are not entitled to have chemistry lessons by teachers who have a sound and guaranteed, university-level chemistry background.

Too easy to feel a little uncomfortable.

### **Acknowledgements.**

Many thanks to head of ISIS "Paolo Carcano" Anna Cornaggia, to colleagues and personnel who are supporting my didactic work, and to Claudia Cantaluppi who, once more, has reviewed my paper.

### **My special appreciation:**

- to my first chemistry teacher, Annamaria Lisdero, who showed me that you can learn from your younger students more than from many textbooks, if you're not afraid of asking their opinions;

- to my students along many years, in schools, universities or industries; especially my 2011/2012 classes at Setificio, 4C1, 4C2 and, above all, 2C2 and 5T: for their enthusiasm and patience in trying to make something new - or old perchance.

-

### **Reference list**

[1] Shakashiri, B. "Communicating Chemistry Via Demonstrations", *this Conference*.

[2] Cannizzaro, S. "Sunto di un corso di filosofia chimica", Genova, **1858**

[3] Nassau, K. "The Physics and Chemistry of Color", 1<sup>st</sup> ed., Wiley, **1983**

- [4] an., “A Career in Colors”, URL: <http://sciencegeist.net/a-career-in-colors/>
- [5] Murphy, K. L. “Scale literacy of students in foundation-level chemistry courses”, *this Conference*.
- [6] an., “Unravelling the structure of the wool fibre and other keratins”  
<http://www.csiropedia.csiro.au/display/CSIROPedia/Wool+fibres+structure>,
- [7] Palazzi, S. “Origine e metrica del colore - spunti didattici”, X congresso nazionale DD-SCI, Verbania, **1996**. URL: <http://www.kemia.it/testipdf/ORIGINE%20E%20METRICA%20DEL%20COLORE%20web.pdf>
- [8] Coppola, B. P. “The Most Beautiful Theories...” *Journal of Chemical Education* **2007**, *84*, 1902-1911. URL: [http://www-personal.umich.edu/~bcoppola/publications/p\\_1902.pdf](http://www-personal.umich.edu/~bcoppola/publications/p_1902.pdf)
- [9] Coppola, B. P. “Full human presence: the uncut version”, <http://www-personal.umich.edu/~bcoppola/publications/42A.%20Human.pdf>
- [10] Coppola, B. P., “Do real work, not homework”, *this Conference*.
- [11] Planck, M., quoted in [8]
- All web references has been accessed in August, 2012.

## Successful Chemistry Education

Norman REID

University of Glasgow, Scotland; Eldon Street, Glasgow, G3 6NH  
Email: dr\_n@btinternet.com

### Abstract

Published research has indicated several key ways by which we can make chemistry education successful and exciting for all levels of learners. The curriculum aims have been described and the reasons for learner difficulties have been identified and some ways forward tested and found to be highly effective in making chemistry more accessible. The reasons that encourage positive attitudes are known and the ways to encourage positive attitudes demonstrated.

This paper will summarise a few of the key findings and these will point forward to ways to improve chemistry education, especially at school level. Past research also defines the agenda for future enquiry.

It is important that the curriculum for school chemistry meets the needs and aspirations of the majority of learners. To reduce difficulties, the evidence shows clearly that the key lies in appreciating the controlling influence of limited working memory capacity. Research is described where very large improvements in performance can be achieved simply by re-casting the written materials used by the learners in order to minimize mental overload.

The key to positive attitudes lies in curriculum design, quality teaching and making the learners aware of the importance of chemistry as basis for exiting careers. Activity outside the school has almost no effect in encouraging young people to continue their studies in chemistry.

The argument here is that there is sufficient clear, confirmed evidence from quality research to indicate how to move chemistry education forward so that more learners can be released to find chemistry an exciting and fulfilling subject, a goal we all share.

### Introduction

It is sad that, in chemistry education, we so often do not respect the research in the field and are happy to move forward on the basis of opinion, assertions, speculations. Indeed, chemistry education, like other areas of education, is full of 'bandwagons', based on little more than opinion, which are used to plan and develop curricula and teaching. History is littered with the failures arising from these developments.

In order to move chemistry education forward, it is essential to base all our developments on clear evidence from research but research is very variable in usefulness (table 1).

Table 1 - Types of research

Types of Research in Chemistry Education			
1	Post hoc	Looks back at some development and comments sagely	Descriptive research has its place but is very limited
2	Brainchild	Develop a new way to teach, gaining evidence to show it is better	It is <i>always</i> better for the development changes the advocates - very limited value
3	Innovative	Develop a new way based on past evidence and explore its effectiveness	This is part of how the sciences always work. New research builds on past evidence
4	Fundamental	Ask why things work as they do and look for fundamental principles	This is the key: if we know 'why', we can predict and then test the predictions

Sadly, educational research is full with examples of the first two and, as a result, we do not move forward coherently and usefully. This paper seeks to summarise some of the key findings from research in categories 3 and 4. It derives from reviews already published [1-3].

### Some Key Questions

Chemistry education has faced a small number of critical issues in recent decades:

- Knowledge in chemistry is expanding exponentially. At the same time, chemistry is under threat in terms of status and time allocations, especially at school levels. Can we justify its place in the curriculum?
- Why is chemistry often seen as difficult by learners and what can we do to reduce the problems?
- In many (but not all) countries, chemistry is unpopular at senior school and university levels. What causes this and what can we do to improve the situation?

#### (a) *Why study chemistry*

The proportion of the intake in a typical secondary school that will ever study chemistry at university in a serious way is, perhaps, as low as 2% but certainly not more than 5%. Designing the school curriculum to lead to university chemistry means we are failing the needs of the vast majority. Here are some better aims (figure 1):

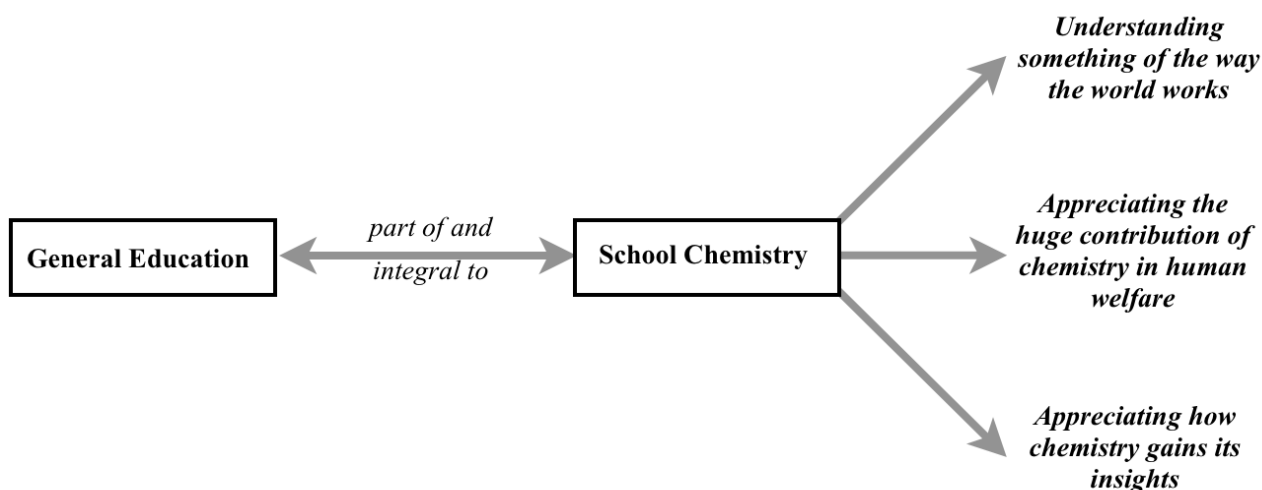


Figure 1 - The Role of School Chemistry

Harvey and Green looked at what employers wished from the graduates they employed (in all disciplines). Knowledge and skills had their place but the employers really wanted some graduates who had the skills and abilities to transform the organization, with more emphasis on specific skills like team-working, report writing, making oral presentations [4].

In another study, chemistry graduates were approached two years after completing their first degree to see how they thought their undergraduate experiences had prepared them for work. The graduates were positive but they also wanted more emphasis on the generic skills the employers had identified [5].

We need to look at the world into which our students move and ask if their experiences in chemistry are preparing them well. This is a key future research area.

#### (b) *What Makes Chemistry Difficult?*

The work started in the late 1960s after the introduction of new curricula in schools in many countries. The areas of difficulty were quickly identified and researchers started to explore the nature of the problems and how they might be resolved.

In the 1950s, a study in psychology led to the paper with the amazing title: 'The magical number  $7 \pm 2$ '. Published in a prestigious psychology journal, this quickly became one of the most quoted papers of all time. Miller had developed reliable ways to measure the capacity of what he called 'short-term memory' [6]. In a moment of inspiration, Johnstone and Kellett [7] connected the findings of Miller to work on dif-

difficulties in understanding chemistry. In simple terms, they hypothesized that difficulties in understanding arose when the human brain was asked to handle too many ideas at the same time.

In a rigorous experiment, this hypothesis was tested by Johnstone and Elbanna [8,9]. They found that the capacity of what is now known as ‘working memory’ was, indeed, the key factor determining success in much chemistry. Later, it was shown that this applied to all subject areas but the problems are most acute in highly conceptual areas [10]. To grasp a concept, the learner almost inevitably has to hold many ideas simultaneously. This may well overload the working memory and cause understanding to be more or less impossible.

The controlling effect of limited working memory capacity is considerable. The average adult can hold 7 ideas (Miller called them ‘chunks’) at the same time. Learners with small working memory capacities can often perform much less well (typically between 15% and 25%) in examination papers. The problem is that the capacity of working memory is determined genetically and cannot be expanded. It is simply a function of the way the brain is wired up and does not, of itself, determine ability.

Here is an extreme example of the kind of question which almost inevitably will overload the working memory: “If 20 ml of 0.02M potassium permanganate is acidified and treated with excess potassium iodide solution, iodine is released. When this iodine is titrated against 0.1M sodium thiosulfate solution, using starch indicator, what volume of thiosulfate would be used ?” However, there is a way to solve this without overloading the working memory [3].

The working memory is where we think, understand and solve problems. Much of the rest of the brain is simply a store for holding information, understandings, opinions, experiences and so on. In learning, if the capacity of the working memory is exceeded, understanding is more or less impossible.

The critical importance of working memory is stressed in a review by Kirschner et al. [11]. The paper is entitled: “Why minimal guidance during instruction does not work: An analysis of the failure of constructivist, discovery, problem-based, experiential, and inquiry-based learning”. They talk of FAILURE. They then list a whole number of fashionable approaches which can be seen commonly in much chemistry education today. The point they are making is this: NONE of these ways holds the key in solving the difficulty issue and they note:

‘Any instructional theory that ignores the limits of working memory when dealing with novel information or ignores the disappearance of these limits when dealing with familiar information is unlikely to be effective. (p. 77).

Constructivism has as its central tenet that learners construct their own understandings and that these may not be the same as the understandings provided by the teacher. The evidence for this is overwhelming. However, suggesting that we can teach constructivistically is simply a nonsense. All learners, all the time, are constructing their understandings. It does not matter what we do. Teaching constructivistically is meaningless in that constructing understanding takes place inside the head of each learner, inaccessible to the teacher.

Constructivism is an excellent description of what goes on naturally. It has little predictive value and cannot direct us to better teaching, simply because what happens overtly in the classroom has no direct bearing on a process which takes place naturally inside the head of each learner.

Kirschner et al. speak of discovery, problem-based, experiential, and inquiry-based learning.[11]. All these are what might be seen as trendy ‘bandwagons’ that have gained certain currency among certain educators. While all four possess positive features, none of them holds the answer. If they are implemented within the limitations of working memory capacity in mind, they may bring better learning. If they generate increased cognitive loads, then learning will deteriorate. It is nothing specifically to do with the type of learning. The research shows that they can sometimes bring benefit and sometimes bring disbenefit. That is simply because the fundamental issue of understanding is not being addressed.

It has been established for decades that measured working memory capacity correlates with performance. It was established incontrovertibly that this is cause-and-effect [8,9]. This leads to a simple prediction: restructuring the entire learning process to minimize possible working memory overload should lead to much better performance.



Danili took small sections of the Greek chemistry syllabus and re-cast the written materials used by the school students, deliberately seeking to minimize potential overload. She measured performance before and after, using an experimental group (that used her new materials) and a control group (that used the 'normal' materials). Nothing else was changed. 211 students were involved and one of her topics was the mole, known for its difficulty. The control group showed a gain of 13% in the test while the experimental group showed a gain of 22%, significant at  $p < 0.001$  [12].

Later, Hussein re-cast large sections of the school curriculum in chemistry in The Emirates for two year groups (aged about 16-17). Each of four groups undertook one major topic using his new materials and another major topic using the traditional materials. Thus, every group acted as both an experimental and a control group, ensuring that random sampling did not affect the outcomes. There were no changes in time allowed, content covered, and no school was visited and no training of teachers was offered at all.

His results (table 2) were very clear [13]:

**Table 2 - Performance Measurements [13]**

N = 800	Mean (%)	Gain	t-test	Probability
<b>Periodic Table (year 10)</b>				
<i>Experimental Group</i>	79.2	18.2	26.2	p < 0.001
<i>Control Group</i>	61.0			
<b>Chemical Equations (year 10)</b>				
<i>Experimental Group</i>	80.2	9.2	9.7	p < 0.001
<i>Control Group</i>	71.0			
<b>Organic (year 11)</b>				
<i>Experimental Group</i>	71.0	14.0	19.7	p < 0.001
<i>Control Group</i>	57.0			
<b>Acids and Alkalis (year 11)</b>				
<i>Experimental Group</i>	75.0	10.7	15.1	p < 0.001
<i>Control Group</i>	64.3			

The improvements are simply massive although only the written materials were re-cast. It is only possible to speculate what the outcomes might have been if the teaching itself had also reflected this approach or if previous learning of underpinning ideas had followed the same approach.

It has to be stressed that taking account of the limitations of limited working memory capacity does NOT imply reducing the demand level of the chemistry to be taught. It does mean changing the way that chemistry is presented, to bring it into line with the way the brain operates [14]. Indeed, there is considerable circumstantial evidence that more demanding chemistry can be made accessible.

### **(c) Attitudes towards chemistry**

In many countries learner attitudes towards their studies in chemistry are not very positive. Some work in physics has shown the key reasons [15], summarized in table 3.

**Table 3 - Factors attracting learners**

Factors	Description
The quality of the curriculum	Did what was taught allow the learners to make sense of their world?
The quality of the teacher	Was the teacher competent in the subject discipline, enthusiastic, committed and interested in the welfare of the learners?
The perceived career potential of physics	Did it lead to opportunities where there was a good livelihood.

The kind of curriculum which learners found really attractive has been analysed and exemplified [16,17]. However, the most important finding from Skryabina is the things that she found were of little influence [15]. It is fashionable to develop all kinds of exciting demonstrations and take these to primary schools or even shopping malls. Children are held spellbound. Sadly, there is more or less no lasting effect. Indeed, the children would be held just as spell-bound by a competent magician running a magic show. For chemistry, when not understood, can be just like magic. Indeed, most of such shows, while great fun, have the enormous potential to generate all kinds of misconceptions.

It is not surprising that what goes in schools holds the key influences that attract learners towards the sciences or otherwise. The lesson is that, if we want to improve attitudes towards chemistry, there are three areas needing attention (figure 2).

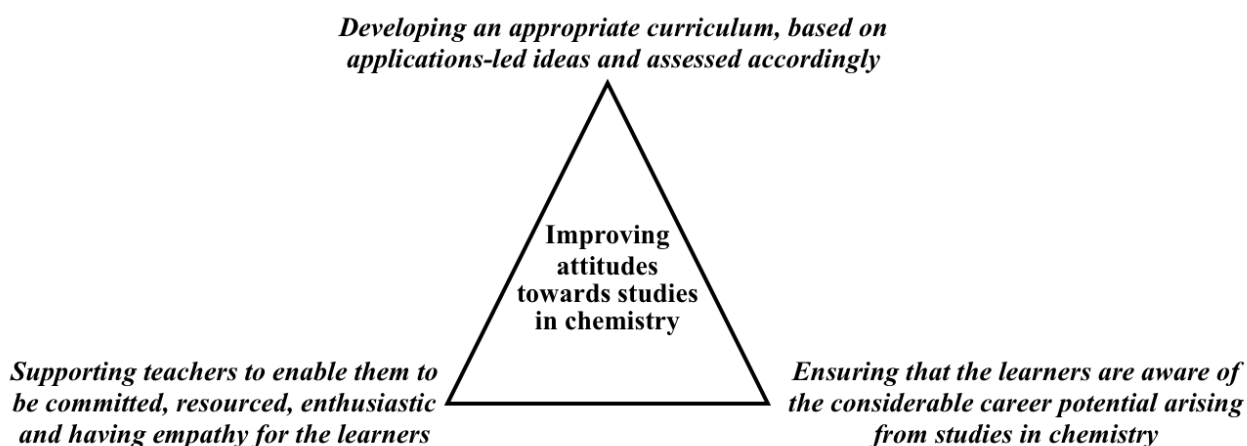


Figure 2 - Developing positive attitudes

It is interesting to note that working memory is also important with attitudes. This arose as a chance observation made in the experiment carried out by Hussein in The Emirates. He found that attitudes had changed quite dramatically when compared to groups who not undertaken any of his new materials. Table 4 shows three of his questions illustrating what he found [13]:

Table 4 - Some attitude changes [13]

N = 800		%						$\chi^2$ (p)
<i>I like chemistry lessons</i>	<i>Control</i>	40	17	11	10	12	10	<i>I do not like chemistry lessons</i> 36.7 (< 0.001)
	<i>Experimental</i>	70	10	3	2	3	12	
<i>I am enjoying the subject</i>	<i>Control</i>	15	24	13	25	9	14	<i>I am not enjoying the subject</i> 104.2 (< 0.001)
	<i>Experimental</i>	66	6	2	2	5	19	
<i>I am getting better at the subject</i>	<i>Control</i>	35	23	15	12	9	6	<i>I am not getting better at the subject</i> 67.5 (< 0.001)
	<i>Experimental</i>	68	6	2	1	7	16	

Overall, he found that he had turned a population which were fairly negatively disposed towards chemistry into a population which was very positive about all aspects of their learning in chemistry. Later, Jung measured the working memory capacity of over 700 young school learners in South Korea and then related the measured working memory capacity to their responses to some very pointed questions. She showed that those with lower working memory capacities tended to have much less interest in science [18]. This led her to ask another question about how they tried to learn in science (table 5).

Table 5 - Ways of Learning [18]

	Level 1 Age 12-13			Level 3 Age 14-15		
	<i>Working Memory Capacity</i>			<i>Working Memory Capacity</i>		
	High (N = 100)	Mid (N = 166)	Low (N = 98)	High (N = 95)	Mid (N = 172)	Low (N = 83)
<i>I have tried to understand science</i>	71%	54%	50%	70%	61%	37%
<i>I have tried to memorise science</i>	24%	34%	39%	21%	35%	45%

About 70% of those with above average working memory capacity said they are trying to understanding. However, with lower working memory capacity, they tended to resort to memorization. The likely reason for this is that the lower capacity working memory simply does not allow understanding [18]. It is well established that understanding is the natural way to learn [19]. Thus, the demands on working memory are forcing learners towards memorization as the only way to pass examinations. This leads to less positive attitudes towards learning in the sciences.

### Conclusions

There is now a very considerable research literature in science education, a little of which has been summarized here. Much of the literature simply describes things that are happening and problems that are apparent. Some describes the inevitable 'success' of novel ways of teaching suggested by enthusiastic teachers, with little evidence of transferability. The most useful literature shows how understandings have developed by means of series of experiments that build on each other while a few papers have explored the reasons why such patterns are observed.

Around 1992, Johnstone developed a set of ten principles that outlined what was known at that time which could act as a guide for university lecturers in developing suitable learning experiences at first year university level [20]. These principles probably apply to much wider situations. Here is my own summary (figure 3):

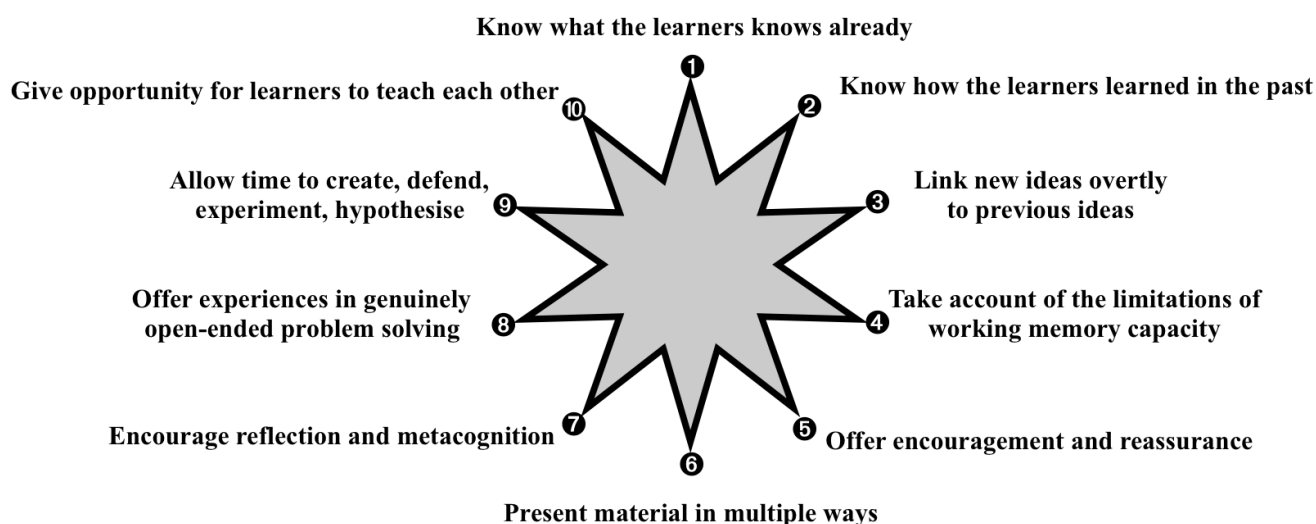


Figure 3 - Ten Principles

There is much to help us here.

Endpiece

There are, perhaps six broad areas where chemistry faces issues (table 6):

**Table 6 - Key Findings**

Area of Concern	Key Findings	Key References
Curriculum Design	Design around the needs of the learner, enabling them to make sense of their world	[16,17,21]
Gaining Understanding	All teaching materials and approaches must take account of the limitations of limited working memory capacity	[11,20,22,23]
Problem-solving	Most problems are simply algorithmic exercises. The range needs widened.	[24-27]
Attitudes	The only important factors are the curriculum quality, the teacher quality, perceptions of earning potential	[15]
Assessment	Most assessment only measures recall no matter how hard we try. Totally new approaches are needed as assessment distorts the learning	[28-30]
Thinking	There are some recent studies on aspects of thinking that need followed up and applied	[31-36]

If we simply applied what is already well established through research, then many of the current problems would be reduced considerably. If we build our future research on the issues raised by these studies, then the next stage of findings will be valuable. More learners can be released to find chemistry an exciting and fulfilling subject, a goal we all share.

## References

- [1] N. Reid, Chem. Ed. Res. Pract., 2008, 9(1), 51-9.
- [2] N. Reid, J. Sci. Ed., 2009, 10(1), 43-44.
- [3] N. Reid, Chem. in Action, 2010, 90, 29-44.
- [4] L. Harvey and D. Green, Quality in Higher Education: Employer Satisfaction, Report, Birmingham: UK, 1980.
- [5] S. Hanson and T.I. Overton, Graduate Survey, Hull: The Higher Education Academy, Physical Sciences, 2010.
- [6] G. Miller, Psy. Rev., 1956, 63(2), 81-97.
- [7] A.H. Johnstone and N.C. Kellet, Eur. J. Sc. Ed. 1980, 2(2), 175-81.
- [8] Johnstone, A.H. and H. El-Banna, Educ. in Chem., 1986, 23(3), 80-84.
- [9] Johnstone, A.H. and H. El-Banna, Stud. in Higher Ed., 1989, 14(2), 159-168.
- [10] H. Hindal, N. Reid and M. Badgaish, Res. in Sc. and Tech. Ed., 2009, 27(2), 187-204.
- [11] P.A. Kirschner, J. Sweller and R.E. Clark, Educ. Psy., 2006, 41(2), 75-86.
- [12] E. Danili and N. Reid, Res. in Sc. and Tech. Ed., 2004, 22(2), 203-226.
- [13] F. Hussein and N. Reid, Res. in Sc. and Tech. Ed., 2009, 27(2), 161-186.
- [14] A.H. Johnstone, Chem. Ed. Res. Pract., 2000, 1(1), 9-15
- [15] N. Reid, and E. Skryabina, Res. in Sc. and Tech. Ed., 2002, 20(1), 67-81.
- [16] N. Reid, Staff and Educ. Dev. Int., 1999, 3(1), 71-84.
- [17] N. Reid, Chem. Ed. Res. Pract., 2000, 1(3), 381-39.
- [18] E-S Jung and N. Reid, Res. in Sc. and Tech. Ed., 2009, 27(2), 205-224.
- [19] B.J. Wadsworth, Piaget's theory of cognitive development. New York: D. McKay, 1971.
- [20] A.H. Johnstone, J. Chem. Ed., 1997, 74(3), 262-268.
- [21] N. Mbajjorgu and N. Reid, Factors Influencing Curriculum Development in Chemistry, Higher Education Academy, Hull, ISBN 1-903815-16-9, 2006.
- [22] N. Reid, Res. in Sc. and Tech. Ed., 2009, 27(2), 131-138.
- [23] N. Reid Res. in Sc. and Tech. Ed., 2009, 27(2), 245-250.
- [24] G. Bonder, Purdue University department of Chemistry, [http://www.chem.purdue.edu/people/faculty/PubList.asp?faculty\\_id=27](http://www.chem.purdue.edu/people/faculty/PubList.asp?faculty_id=27). Accessed 19 August 2012
- [25] N. Reid and M-J. Yang, Res. in Sc. and Tech. Ed., 2002, 20(1), 83-98.
- [26] N. Reid and M-J. Yang, Int. J. Sc. Ed., 2002, 24(12), 1313-1332.
- [27] C.A. Wood, Creative Problem Solving in Chemistry, London, Royal Society of Chemistry, ISBN 1-870343-28-X, 1993.
- [28] K. Almadani, N. Reid and S. Rodrigues, Prob. in Educ. in 21st cent., 2011, 32, 9-22.

- [29] A. Ambusaidi and A.H. Johnstone, Chem. Ed. Res. Pract., 2000, 1(3), 323-328.
- [30] A. Ambusaidi and A.H. Johnstone, Chem. Ed. Res. Pract., 2001, 2(3), 313-327.
- [31] N. Reid and L. Serumola, J. Sci. Ed., 2006, 7(1), 1-15.
- [32] N. Reid and L. Serumola, J. Sci. Ed., 2007, 7(2), 88-94.
- [33] F. Al-Ahmadi and N. Reid, J. Sci. Ed., 2011, 11(2), 53-59.
- [34] F. Al-Ahmadi and N. Reid, J. Sci. Ed., 2012, 13(1), 18-23.
- [35] J. Garratt, T.I. Overton and T. Threlfall (1999) A question of chemistry : creative problems for critical thinkers, Harlow : Longman, 1999.
- [36] K. Robinson, Out of our Minds - Learning to be Creative, Chichester, Capstone Publishing Ltd, 2010.

## Learning to Teach Nature of Science - The Impact of an Explicit Approach

Christiane S. REINERS

*Institute of Chemistry Education, University of Cologne, Germany  
Herbert-Lewin-Straße 2, D-50931 Cologne  
E-mail: christiane.reiners@uni-koeln.de*

### Abstract

*Though there is an overall agreement that students have to be taught about Nature of Science there is a considerable disagreement on what version.*

*This study explores the impact of an explicit approach on pre-service chemistry teachers' understanding of Nature of Science. In order to enable them to address Nature of Science aspects in their future teaching a contextualized and functionalized explicit instruction was used. Data were collected by an open-ended questionnaire in conjunction with semi-structured individual interviews before, during and after the course, and portfolios in order to generate in-depth-profiles and their development.*

*Results and implications for developing a sustainable understanding of Nature of Science that enables teacher students to put it into practice are discussed.*

**Keywords:** Nature of Science (NOS), contextualization, functionalization, chemistry teacher education.

### 1 Strategies for Teaching Nature of Science

Though the discussion about NOS has lasted for many years, involving many different people (historians, scientists, philosophers, science educators) it is still difficult to arrive at a precise definition. But by bearing in mind that students and teachers are addressed there is a certain level of acceptance described by Lederman: "NOS typically refers to the epistemology of science, science as a way of knowing, or the values and beliefs inherent to scientific knowledge and its development" [1]. But "although almost everyone agrees that we ought to teach students about the nature of science, there is considerable disagreement on what version ought to be taught" [2].

Over the past decades many strategies to teaching NOS have been developed [3] which can be roughly categorized as implicit and explicit approaches. "Implicit attempts utilized science process-skills instruction or engagement in science-based inquiry activities...explicit attempts used instruction geared towards various aspects of NOS and/ or instruction that utilized elements from history and philosophy of science" [3]. In their critical review of the studies undertaken to improve science teachers' conceptions of NOS, Abd-El-Khalick and Lederman concluded that "an explicit approach was generally more 'effective' in fostering 'appropriate' conceptions of NOS among prospective and practising science teachers" [3]. But even the success of explicit approaches seems to be limited [4]. Recently further aspects of instruction have turned out to be necessary conditions for an effective instruction: contextualization and functionalization.

„In contextualized instruction, the nature of science is integrated within specific science content. Specific examples of such integration include embedding nature of science concepts within (a) instruction about the development or modern conceptions of the structure of the atom, (b) argumentation and debate concerning socioscientific issues, and (c) developing process skills" [5]. The aspect of functionalization stresses the fact, that understanding NOS is not just declarative knowledge, but the competence for applying NOS understanding in a certain context. "NOS is not a philosophy of science... Labels and formal definitions must yield to a practical and functional understanding" [6]. In order to assess NOS understanding as a competence it should be embedded in a content. In accordance with recent studies intertwining NOS and content instruction has several advantages: It makes learning about NOS more meaningful to the students, NOS becomes an integral instead of an additional part of teaching and with it helps to overcome time constraints which are often an excuse for teachers for not dealing with NOS [7].

## 2 Purpose and content of the study

The present study tries to consider both aspects, contextualization and functionalization and to find answers to the following research questions:

- What is the impact of contextualized and functionalized instruction on pre-service chemistry teachers' understanding of NOS?
- How do their understandings of NOS develop from pre-, mid- to post-instruction?

After an initial instruction to important NOS aspects along the book of Chalmers [8] these aspects were embedded and applied to chemistry content. With respect to results of a previous study which revealed students' difficulties especially in recognizing the nature of laws and theories [9] the research focus in the second step was on theories and laws in chemistry (e.g. atomic theories, valence bond theory, ideal gas law, active mass law stoichiometrical laws, law of crystallography). For instance: In order to apply the notion of a scientific law to a chemical content the students attended an interview by D. Shechtman [10] who was asked: "What was the accepted scientific paradigm about the structure & symmetry of crystals at the time of your discovery?" Shechtman answered that the paradigm or law of crystallography comes from the observation that crystals are ordered periodically and his discovery of 5-fold symmetry was forbidden. Apart from the fact that Shechtman also describes his struggle until the final acceptance of his results the students could learn from this interview that laws are not absolute but principally hypothetical and constructed. In the third step NOS aspects were embedded within instruction about the development of oxidation theories).

## 3 Methodology

The study was conducted in two parallel seminars for pre-service chemistry teachers at the end of their studies. Every chemistry teacher in Germany has to study two subjects, i.e. chemistry and any other subject. Each seminar lasted 14 weeks with 2 hours per week. In total the participants numbered 42 participants (19 female, 23 male).

The improvement of the teachers' NOS views was based on the analysis of responses to a semi-structured questionnaire. The items of the questionnaire were developed by the researcher and addressed problems which have emerged again and again in 20 years of teaching chemistry. The questionnaire was followed by semi-structured interviews with a randomly selected set of four students during which they were asked to clarify their responses and give more examples. The interviews also aimed to generate in-depth profiles of participants' views. They lasted 20-30 minutes and were conducted by the author and another chemistry education researcher familiar with NOS aspects. The results were transcribed verbatim and translated by the author. Questionnaire as well as interviews were administered before, during and after the courses.

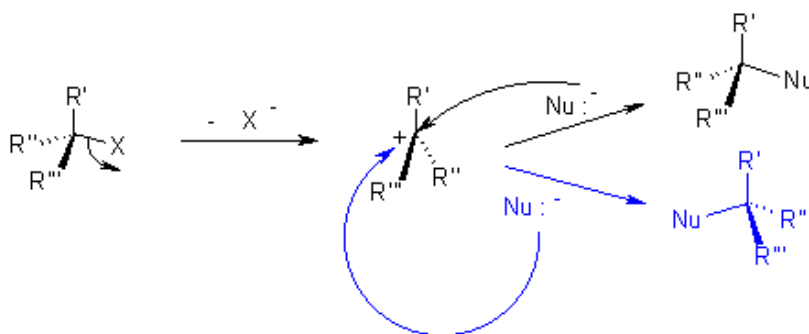
Data Analysis occurred at two levels. On the one hand the analysis of the pre-, mid- and post-instruction provides classification of the participants' views as naïve, informed and no answer. Additionally the participants' justifications were analyzed and the "informed" answers were related to adequate, not adequate and no justification. All data were analyzed by the author. A blind round of analysis was conducted by a further science researcher. Blind analysis and analysis of the author were compared and showed relatively high agreement. A few differences were resolved by further consultation of the data.

The interviews and the questionnaire were analyzed in accordance with the content analysis presented by Mayring [11].

## 4 Results

On the whole we could make some general observations, e.g. an increasing participation in the discussion towards the end of the courses, especially when NOS aspects were applied to chemical content. Furthermore the results reveal how important it was to analyze their justifications as well. For instance the students were asked:

Question 2: The following reaction mechanism describes a nucleophilic substitution.



Do you think that scientists are sure that the reaction runs like that? Please explain.

The postinstruction responses (Fig. 1) indicated some important shifts from their naïve views to more informed views. But looking at the “informed” views” more precisely it turned out that nearly half of them were not able to justify their answer adequately in the pre-test (Fig. 2).

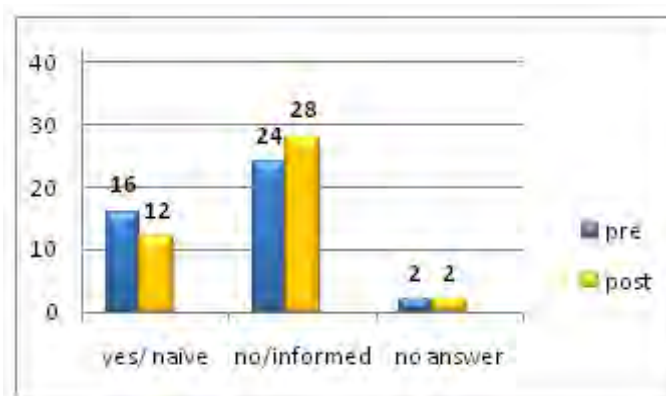


Fig 1 Pre- and post instruction responses

This changed dramatically in the post-test. Nearly everyone with an informed view was able to give an adequate justification (Fig. 2).

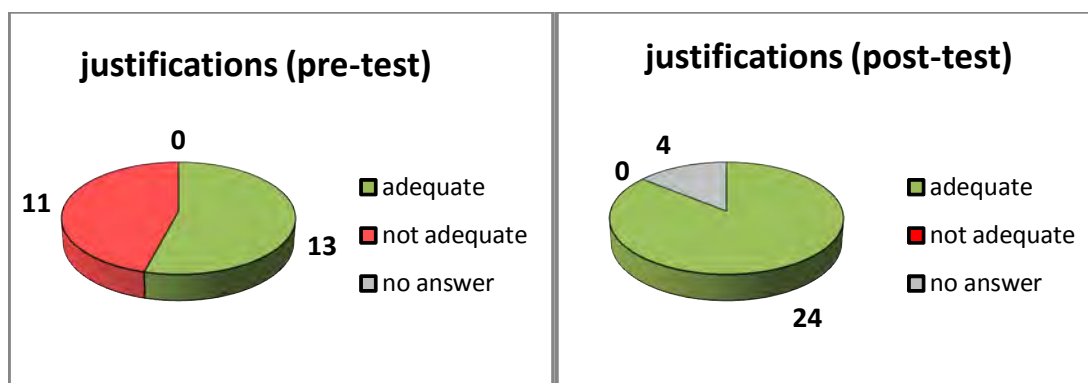


Fig 2 Pre- and post-instruction justifications

An adequate answer was: *No, they cannot be sure because the reaction mechanism is only a model which can explain the properties (racemic mixture) of the product.*

An example of a not adequate answer is: *No, but scientists believe in it.*



The analysis of the interviews as well as the portfolios offered the opportunity to have a closer look on the individual development:

I: „Did your notion of laws and theories change during the seminar and how?

„If a theory has been proven very often, it becomes a law.“ (S3 pre)

„I have never thought about terms like laws and theories before. I just adopted them without reflection.“ (S3 post)

„The only difference between theories and laws is that I can describe a theory with words and a law is always something mathematical, something with numbers which result from measurements (S1/ pre)

„I would not say that my notion of laws has changed but that it has been formed for the first time“(S1 post)

The pre-service teacher students showed marked improvement in their understandings of the nature of laws and theories. Furthermore their responses reveal that they reflect of NOS aspects for the first time.

## 5 Summary and Implications

On the whole the students' views on NOS aspects changed during the course. Especially their justifications became more adequate when NOS aspects are applied to chemical content. But it also turned out that the character of laws and theories seems to be domain specific which can cause “new “ problems expressed by one of the students during the interview:

S4: “Now I have problems that I did not have before.”

I: “Why?”

S4: “... because in biology we were taught that a law is above all, especially above theory.”

Though this answer is not representative it gives cause to conclude that NOS instruction should not only be contextualized and functionalized, but also taught interdisciplinary.

## 6 References

- [1] N. G. Lederman: Nature of Science: Past, Present, and Future. In: S.K. Abell, N.G. Lederman (eds.) Handbook of Research on Science Education, 2007, p. 831–879. Lawrence Erlbaum, New Jersey, London, 2007.
- [2] W. B. Stanley, N. Brickhouse, N., Science Education, 2001, 85, 35-49.
- [3] F. Abd-El-Khalick, N.G. Lederman, International Journal of Science Education, 2000, 22, 665–701.
- [4] R. Khishfe, Journal of Research in Science Teaching, 2008, 45, 470-496.
- [5] R.L. Bell, J.J. Matkins, B.M. Gansneder, Journal of Research in Science Teaching, 2011, 48, 414-436.
- [6] D. Allchin, Science Education, 2011, 518-542.
- [7] F. Abd-El-Khalick, Physics Education, 2002, 37, 64-68.
- [8] A.F. Chalmers, What is This Thing Called Science? University of Queensland Press, Queensland, 1999.
- [9] J. Bruns, Auf dem Weg zur Förderung naturwissenschaftsspezifischer Vorstellungen von zukünftigen Chemie-Lehrenden, Logos, Berlin, 2009. See also Ch. S. Reiners: Reflection on Nature of Science (NOS) Aspects by Teaching Scientific Inquiry. In: L. Menabue, G. Santoro (eds.) New Trends in Science and Technology Education, pp. 207-214, Clueb, Bologna, 2010.
- [10] <http://www.youtube.com/watch?v=EZRTzOMHQ4s&noredirect=1>, accessed 10 July, 2012.
- [11] P. Mayring, P. Qualitative content analysis – research instrument or mode of interpretation? In: M. Kieglmann (Ed.), The Role of the Researcher in Qualitative Psychology, pp. 139-148. Huber, Tübingen, 2002.

## What is the Concentration of Stones at the Bottom of the Sea? – Pitfalls and Errors in Teaching of Chemical Equilibrium

Vibor ROJE

Faculty of Forestry, University of Zagreb, Svetošimunska cesta 25, HR-10000 Zagreb, Croatia  
E-mail: vroje@sumfak.hr

### Riassunto

*Le lezioni dedicate all'equilibrio chimico fanno parte di quasi ogni curriculum di chimica generale – sia nelle scuole secondarie superiori che al livello universitario. Purtroppo, parecchi manuali di chimica generale contengono errori fondamentali nelle interpretazioni delle costanti di equilibrio per le soluzioni acquose degli acidi e basi deboli e quelle dei sali o idrossidi scarsamente solubili. Per essere più precisi, nell'insegnamento di chimica, emerge una pratica delle false derivazioni delle costanti dell'equilibrio della ionizzazione degli acidi e basi deboli e prodotti di solubilità dei sali ed idrossidi che si basano sulla sbagliata interpretazione della concentrazione come grandezza fisica e conseguente uso improprio di essa. Così nelle esplicazioni si può trovare cosiddetta concentrazione d'acqua ( $[H_2O]$ ) e "concentrazione" dei solidi puri (ad esempio  $[AgCl]$ ); entrambi gli esempi rappresentano gli errori sostanziali. Finalmente, uno deve tenere presente che le costanti di equilibrio, espressi nei termini di concentrazione, generalmente non sono adimensionali.*

### Abstract

*The lessons devoted to chemical equilibrium take part of (almost) all general chemistry curricula – either at the secondary school level or at the university level. Unfortunately, there are numerous general chemistry textbooks which contain some fundamental errors in the interpretation of the equilibrium constants regarding aqueous solutions of weak acids and bases as well as solutions of sparingly soluble salts and hydroxides. Namely, in the chemistry teaching the practice of incorrect derivations of the equilibrium constants expressions for the ionization of weak acids and bases, along with the expression for solubility product of salts and hydroxides, which are the consequence of the misinterpretation of the molar concentration as a physical quantity, often occur. Thus, in the textbooks one can find so-called concentration of water ( $[H_2O]$ ) and "concentration" of the pure solids (e.g.  $[AgCl]$ ); both examples represent substantial errors. Finally, one should take into account that the equilibrium constants, when expressed in the terms of concentration, are generally not dimensionless quantities.*

**Parole chiavi:** concentrazione molare / costante d'equilibrio / equilibrio chimico / frazione molare / prodotto di solubilità

**Keywords:** chemical equilibrium / equilibrium constant / molar concentration / mole fraction / solubility product

### 1. Introduction

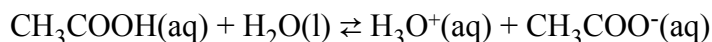
It is well known that the lessons concerning the basic chemical equilibrium principles are included in (general) chemistry curricula – both at high school as well as on the university level. Probably, there is no general chemistry course which does not include at least a brief overview of chemical equilibrium. Consequently, the discussions on chemical equilibrium are present in most general chemistry textbooks: either as self-standing chapters, or in the chapters dealing with acids, bases and salts chemistry.

In this paper will be given a short critical insight into an (often incorrect) practice in teaching of the chemical equilibrium in water solutions of weak acids and bases and 'insoluble' hydroxides and salts.

## 2. Ionization of weak acids and weak bases

### 2.1. Ionization of weak acids

Let us take acetic acid as an example of a weak acid (simply to avoid a manipulation with general formulae such as HA). The ionization of acetic acid is given by the equation:



How the expression of the equilibrium constant for such an ionization have to be derived?

What is the correct way to derive the expression of the equilibrium constant (expressed in the term of molar concentration) for such ionization?

Unfortunately, in lots of textbooks, even those which are generally very good and widely appreciated, *e.g.* [1-4], we can find this (and, needless to say, many school teachers and university professors follow it):

$$K_a = \frac{[\text{H}_3\text{O}^+] \times [\text{CH}_3\text{COO}^-]}{[\text{CH}_3\text{COOH}] \times [\text{H}_2\text{O}]}$$

So, what does the term  $[\text{H}_2\text{O}]$  mean? The molar concentration of water? Can 'concentration' of water be calculated at all? It is true that there exists a certain value –  $55.5 \text{ mol L}^{-1}$  – which some chemists understand as the „concentration of water in water“, but it should be noticed that it is something completely erroneous. There are at least two reasons why this is so:

- 1.) talking about concentration of pure water (*i.e.* pure liquid substance) is senseless, because the molar concentration is a physical quantity which is defined as a ratio of the amount of a solute and volume of the solution [5]:

$$c_B = \frac{n_B}{V}$$

- 2.) on the other hand, how much of a solvent is present in the solution must not be expressed in the terms of molar concentration, but should be expressed in terms of a mole fraction,  $x$  [6-8].

So,  $K_a$ , in the terms of concentration, for acetic acid should be written as follows:

$$K_a = \frac{[\text{H}_3\text{O}^+] \times [\text{CH}_3\text{COO}^-]}{[\text{CH}_3\text{COOH}] \times x(\text{H}_2\text{O})}$$

Then the mole fraction of water,  $x(\text{H}_2\text{O})$ , can be approximated to  $\approx 1$ , and technically omitted from the expression which now takes a form:

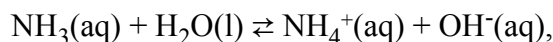
$$K_a = \frac{[\text{H}_3\text{O}^+] \times [\text{CH}_3\text{COO}^-]}{[\text{CH}_3\text{COOH}]}$$

One should notice that this is the only possible way for deriving this simple equation for  $K_a$  of weak acids. Therefore, it should be emphasized that the derivation of the equation for  $K_a$ , from the equation containing a 'strange' term  $[\text{H}_2\text{O}]$ , where  $K_a'$  is „combined“ with it to yield  $K_a$  is wrong and such approach, even though presented in many textbooks, should be neglected.

### 2.2. Ionization of weak molecular bases

For weak bases, such as ammonia, the same procedure for deriving of the expression of the ionization

constant should be applied:



$$K_b = \frac{[\text{NH}_4^+] \times [\text{OH}^-]}{[\text{NH}_3] \times x(\text{H}_2\text{O})}$$

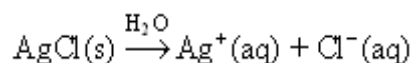
If  $x(\text{H}_2\text{O}) \approx 1$ , then we have:

$$K_b = \frac{[\text{NH}_4^+] \times [\text{OH}^-]}{[\text{NH}_3]}$$

### 3. Ionization of the 'insoluble' salts and hydroxides

In addition to the errors which occur in teaching of chemical equilibrium of (weak) acids and bases, the interpretation of chemical equilibrium in water solutions of insoluble hydroxides and salts also suffer from some, let say so, 'typical' errors (which also can be found in the known textbooks, *e.g.* [1,3,4]).

Let be taken in a consideration a dissociation of silver(I) chloride:



In certain textbooks one can find the equilibrium constant for this dissociation written as:

$$K_c = \frac{[\text{Ag}^+] \times [\text{Cl}^-]}{[\text{AgCl}]}$$

And what is the term  $[\text{AgCl}]$ ? Perhaps a “concentration” of the excess of pure solid (silver(I) chloride) which is in equilibrium with dissolved  $\text{Ag}^+$  and  $\text{Cl}^-$  ions?? Well, since it is well known that the amount concentration is defined as a ratio of the amount of the solute and a volume of the solution, one should draw a conclusion that talking about 'concentration' of a pure solid substance (as  $\text{AgCl}$  is) is simply – senseless and it should definitely be avoided. Thus, when the equilibrium constant equation for the dissociation of a sparingly soluble hydroxide or salt (as we use silver(I) chloride as an example) in the terms of concentration is to be written, this denominator should simply be omitted and then we have the 'solubility product' ( $K_s$ ,  $K_{\text{sol}}$ ,  $K_{\text{sp}}$ ):

$$K_s = [\text{Ag}^+] \times [\text{Cl}^-]$$

Finally, it has to be emphasized that derivation of the equation for solubility product of some sparingly soluble salt or hydroxide which includes the equation containing a “concentration” of the pure solid and assuming that “concentration” of such a solid substance is “constant” – is wrong.

Although the activities (along with standard equilibrium constants) are generally not taught to the 1<sup>st</sup> year university students nor to the secondary school students, it can be described here that a solubility product can be derived from the standard equilibrium constant. In the case of the dissociation of silver(I) chloride, a standard equilibrium constant (denoted as  $K$  or  $K^\circ$ ) is:

$$K = \frac{a(\text{Ag}^+) \times a(\text{Cl}^-)}{a(\text{AgCl})}$$

where the activity of a pure solid (*i.e.* AgCl in this example) – by definition – equals to 1. Subsequently, a standard equilibrium constant becomes  $K = a(\text{Ag}^+) \cdot a(\text{Cl}^-)$  and then can be re-written as  $K = (y_{\pm})^2 [\text{Ag}^+] \cdot [\text{Cl}^-]$ . For diluted solutions the activity coefficient  $y \approx 1$ , and the constant becomes a 'solubility product' –  $K_s = [\text{Ag}^+] \cdot [\text{Cl}^-]$ .

#### 4. Dimension of the equilibrium constants

Finally, a bit of attention should be drawn to the confusion regarding dimensions of the concentration-based equilibrium constant, which is widely present in teaching practice. Thus, it is easy to find in various chemistry books the equilibrium constant values without units. That practice, in fact, is not correct, because according to IUPAC's recommendations such constants ( $K_a$ ,  $K_b$ ,  $K_s$ ) are not dimensionless quantities [5,6].

#### 5. Conclusion remarks

- 1) 'Concentration of water',  $[\text{H}_2\text{O}] = 55.5 \text{ mol dm}^{-3}$  is senseless quantity and should not be used at all.
- 2.) Amount of a solvent (in a homogeneous mixture) have to be expressed in the terms of mole fraction,  $x$ .
- 3) 'Concentration' of pure solid substance (*e.g.*  $[\text{AgCl}]$ ) has no sense and should not be used.
- 4) Equilibrium constants, when based on the terms of the amount concentration (such as  $K_a$ ,  $K_b$ ,  $K_s$ ), are generally not dimensionless quantities.

#### Acknowledgments

This presentation was partially supported by "Hrvatske šume d.o.o." ("Croatian forests, ltd.").

#### Literature cited

- [1] C.E. Mortimer, Chemistry, 6<sup>th</sup> ed., Wadsworth Publ. Co, Belmont CA, 1986, pp. 455, 498.
- [2] P.W. Atkins, L. Jones, Chemistry – molecules, matter and change, 3<sup>rd</sup> ed., W.H. Freeman & Co, New York, 1997, p. 519.
- [3] M.S. Silberberg, Chemistry – the molecular nature of matter and change, 2<sup>nd</sup> ed., McGraw-Hill, 2000, pp. 761, 823.
- [4] R. Chang, Chemistry, 8<sup>th</sup> ed., McGraw-Hill, 2005, pp. 590-591, 595.
- [5] IUPAC – Quantities, units and symbols in physical chemistry, 3<sup>rd</sup> ed., RSC Publishing, Cambridge, 2007, pp. 47, 58.
- [6] A.R. Denaro, Elementary electrochemistry, 2<sup>nd</sup> ed., Butterworths, London, 1979, pp. 56, 59-60.
- [7] P.W. Atkins, Physical Chemistry, 5<sup>th</sup> ed., Oxford University Press, Oxford, 1994, pp. 3, 230.
- [8] J. Olmsted, G.M. Williams, Chemistry – the molecular science, Mosby, 1994, pp. 717-720.

## Developing Professional Teaching Competencies of Chemistry Professors

Gloria SÁNCHEZ<sup>1</sup>, Carles FURIÓ<sup>1</sup>, Alfredo PÉREZ<sup>2</sup>

<sup>1</sup>Departament of Didactics of Experimental Sciences, University of Valencia. Av. Tarongers, 4. Postal Code 46022. Valencia, Spain. Tel. (34) 963864483 - Fax (34) 963828290,

<sup>2</sup>Department of Methods of Research and Diagnosis in Education, University of Valencia.  
E-mail: gloria.sanchez@uv.es

### Abstract

*This paper presents the results of implementing a professional training proposal for chemistry professors based on developing their teaching competencies and discusses their relative effectiveness.*

*In order to consider the basics of professor professionalism in systemic and holistic terms, we must necessarily ponder the various areas of social and cultural interaction where professor competencies are acquired and become meaningful, namely interaction with their knowledge of their subject, of themselves and the other parties involved in education and a greater context. Therefore, this training proposal is not confined to one sole teacher training strategy because incorporates the contributions of various trends to add to integral professional teacher training. The results suggest that this proposal helps to qualitatively enhance teachers' reflection on their own practice and facilitates teachers' understandings about inquiry-based teaching in the classroom, and improve the development of teachers' ability to ask inquiry questions.*

**Keywords:** Professional teaching competencies, Professional development of chemistry professors.

### Introduction

From the 90's in Europe and elsewhere in the world have undertaken major reforms of the curriculum to meet international quality standards and allow them to assume the challenges of an increasingly globalized world. However, these reforms can stay on the shelf, as it has happened with much of the earlier reforms, if no action is taken to encourage proper training and involvement of university faculty [1-3].

In this sense, an unresolved is the search for comprehensive models of teacher training that are consistent with the results of research and effective to help the professional development of teachers [4].

This work forms part of the project "Developing Professional Teaching Competencies of Science and Engineering Professors", whose overarching objective was the design and implementation of a comprehensive teacher training proposal for university science and engineering professors based on developing their teaching competencies.

### Objectives

This paper focuses in analyzing the design and implementation process of a training proposal for in-service chemistry professors, aimed to contribute to the improvement of inquiry-based science teaching. The aims were: 1) To identify and to analyze chemistry professors' views on what is know and know-how for quality teaching; b) To analyze the training needs of teachers taking into account both their own perceptions and the perceptions of students and graduates on the strengths and weaknesses of university education received.

### Method

From a constructivist perspective, conceptions, teaching practices, needs and interests of teachers must be the starting point for gradually achieving their professional development. Therefore, this proposal was carried out in three steps: diagnosis, design and implementation.

#### **Step1. Diagnosis:**

- Literature review. We performed a search of the available international literature on studies of university chemistry professors with relation to the following aspects: conceptions, pedagogical

content knowledge in chemistry, attitudes, needs and interests.

- Study on chemistry professors' perceptions on their professional teaching competencies and their training needs. The Delphi Technique was applied in order to constitute the competencies of chemistry teachers based on the professors' views. In this study participated 65 chemistry professors.
- Study on chemistry professors' perceptions on the strengths and weaknesses of university education received during their studies in the first cycle BSc in Chemistry (Bachelor). These perceptions were compared with perceptions of 38 students and 119 bachelors.

### Steps 2-3. Design and implementation of a systemic and holistic training proposal:

Based on the results of diagnosis, we prepared and implemented a training proposal that is not confined to one sole teacher training strategy, but incorporates the contributions of various trends to add to integral professional teacher training: a) teacher learning in professional development communities; b) teacher as researcher; c) The teacher's role in inquiry-based learning and problem-based learning; d) Professional Development through reflection and metacognitive strategies; e) Teacher's in-depth pedagogical content knowledge and subject matter didactics.

## Results and Discussion

The results of literature review suggested that less than 2% of the papers correspond to specific studies of chemistry professors. This is in alignment with the results of a study conducted by Mellado [5], who found that there is a lack of studies on university science teachers.

For the data processing and analysis of results of the diagnostic, we grade teaching competences taking into account the various areas of social and cultural interaction where professor competencies are acquired and become meaningful [6], namely interaction with their knowledge of pedagogical content in chemistry (PCK), of themselves (metacognitive competences) and the other parties involved in education and a greater context (especially with students, other teachers and their institution).

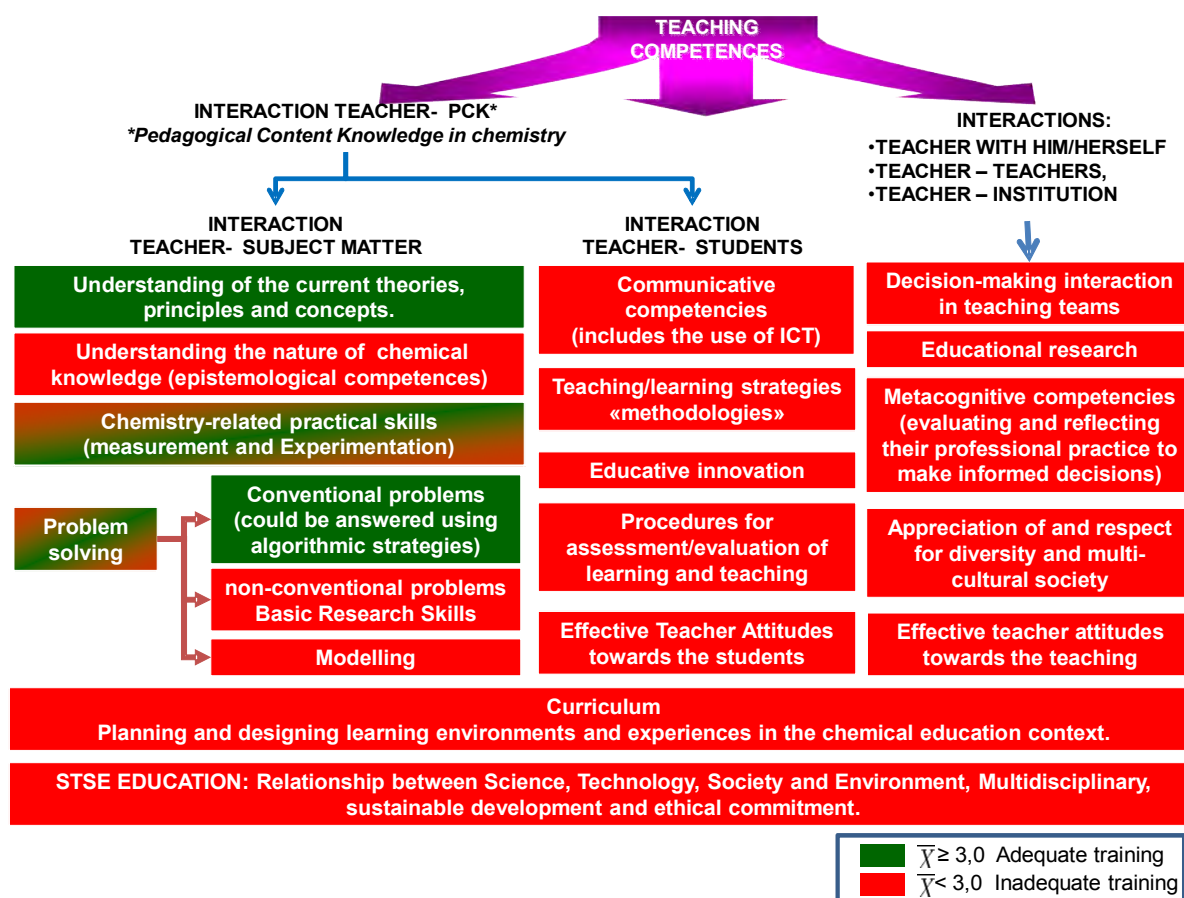


Figure 1: Chemistry professors' perceptions on their professional teaching competencies and their training needs.

As can be seen from Figure 1, professors at the university investigated think that they have greater control of chemistry-related practical skills (measurement and experimentation) and that they can teach to apply such knowledge and understanding to the solution of quantitative problems of a familiar nature. Especially it is noteworthy that students and bachelors consider that during their studies in the first cycle BSc in Chemistry they have been better able to solve quantitative problems of a familiar nature, and that they have greater control of chemistry-related practical skills.

These strengths are the same chemistry competences in which professors feel they have more teaching competence. Also, students and bachelors agree also noted as weaknesses those competencies in which professors think that they need more training to better teach.

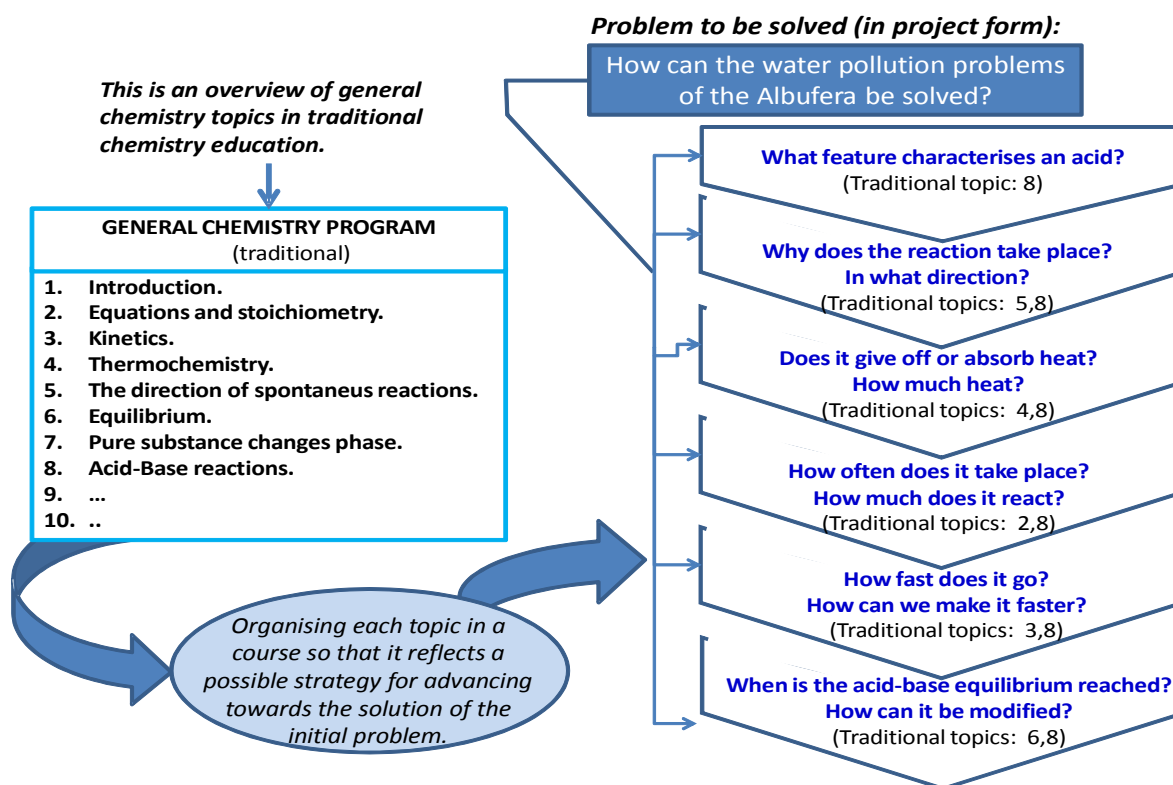
The findings of this investigation are, in this respect, wholly in line with what has been argued in the *report* elaborated by Alison Head and Michael Eisenberg [7], who found that universities may be failing their students at a time when research skills and interactive learning are becoming more important.

• **Evaluating the success of training proposal for in-service chemistry professors:**

With respect to degree of effectiveness of our training proposal, the results indicate that this proposal facilitates teachers' understandings about inquiry-based teaching in the classroom, and improves the development of teachers' ability to ask inquiry questions and a desire to actively use these questions for planning learning activities appropriate to guide their students in problem solving. Figure 2 shows how a professor organized each topic in a course so that it reflects a possible strategy for advancing towards the solution of the initial problem.

Despite these results, most chemistry professors do not feel personally capable of developing and implementing change on their own because they consider that it is for their research that they are judged and rewarded. Therefore, they feel that their teaching is, at best, a secondary obligation.

Since the last decade university accreditations' systems are evaluating educational innovation and educational research in science and engineering education. However, these professional activities continue to be relegated to second place in the universities. In fact, the committees of inquiry at the faculties of science and engineering are not assumed to be educational research as a genuine research.



**Figure 2:** This figure shows how a professor organized each topic in a course so that it reflects a possible strategy for advancing towards the solution of the initial problem.



## Conclusions

While these results demonstrate the effectiveness of the training proposed in this research, it is necessary to create professional teacher training programs and standardized assessment systems in that teaching and educational innovation are essential requirements for promotion and accreditation of chemistry professors.

## Bibliography

1. J. Attali, Pour un modèle européen d'enseignement supérieur. Report de la Commission Jacques Attali. . Ministère de l'éducation nationale, de la recherche et de la technologie. Paris 1998.
2. E. Boyer, The Boyer commission on educating undergraduates in the research universities. Reinventing undergraduate education: a blueprint for America's research universities. Report of the Foundation for the Advancement of Teaching, Washington 1998.
3. R. Dearing, Higher education in the learning society. Report of the National Comittée. National Committee of Inquiry into Higher Education, London 1997.
4. C. Furió, J. Carnicer. El desarrollo profesional del profesor de ciencias mediante tutorías de grupos cooperativos. Estudio de ocho casos. Enseñanza de las ciencias, 2002, 20 (1), 47-74.
5. V. Mellado, La formación didáctica del profesorado universitario de ciencias experimentales. Revista Interuniversitaria de Formación del Profesorado, 1999, 34 (1), 231-241.
6. ICFES-MEN. Proyecto de evaluación de docentes del servicio público estatal. Primera etapa: reconocimiento del quehacer del docente colombiano. ICFES, Bogotá 1998.
7. A. Head, M. Eisenberg, Project Information Literacy Progress Report: "Trunth Be Told". University of Washington, Washington 2010.

## Question-asking on Unfamiliar Chemical Phenomena: Differences between Students, Preservice Teachers and Experts

Kelly Johanna DUQUE<sup>1</sup>, Gloria Sánchez MÁRQUEZ<sup>2</sup> and Vicente SANJOSÉ<sup>2</sup>

<sup>1</sup>Doctoral student at the University of Valencia,  
kellyjohannad@gmail.com

<sup>2</sup>Department of Didactics of Experimental Sciences, University of Valencia.  
Av. Tarongers, 4. Postal Code 46022. Valencia, Spain.  
Tel. (34) 963864483 - Fax (34) 963828290,  
gloria.sanchez@uv.es - vicente.sanjose@uv.es

### Abstract

*Questioning is one of the thinking skills for developing critical thinking, creative thinking in problem solving. Nevertheless, students ask very few questions in usual classroom situations. In this study we examined how experts, pre-service teachers and students of different educational levels facing to unfamiliar chemical phenomena that generate perplexity. The aims were: 1) To stimulate and to analyze the questions asked by students, pre-service teachers and experts when they try to understand chemical phenomena; 2) To study the influence of the level of knowledge on the questions asked. The results obtained support the taxonomy of questions proposed and show that students, preservice teachers and experts generated a relevant and significant amount of questions about phenomena when conditions are appropriate.*

**Keywords:** questioning skills, learning chemistry, experimental devices and science education.

### Introduction

Several researches show that training students to ask questions allows them to discuss about different topics and will improve their comprehension, learning and memory [1-4]. Other studies reveal that asking questions represents a powerful metacognitive activity [5] because promotes reflexive thinking, critical thinking and creative thinking in problem solving [6-9]. According to Bachelard [10], *all knowledge is in response to a question. If there were no question, there would be no scientific knowledge.*

However, students ask very few questions in usual classroom situations and the most of them proceed from the teachers [11]. Furthermore, the vast majority of questions asked by teachers are low-level cognitive and these questions are addressed to memorize and to recall of factual information [12]. What situations encourage students and teachers to ask more effective questions? The situations that encourage, with most likely probability, to ask questions, are those where perplexity is generated and then there is a cognitive conflict, that is, they can't explain what they see with the mental models they have [13-16].

### Objectives

The purpose of this study was to examine how subjects of different educational levels facing to unfamiliar chemical phenomena that generate perplexity. The aims were: a) To stimulate and to analyze the questions asked by subjects when they try to understand chemical phenomena; b) To study the influence of the level of knowledge on the questions asked.

### Methodology

Previously, we selected two chemical phenomena that generate perplexity and we stimulated subjects to ask questions by means of: a) Individual observation of chemical phenomena; b) Subjects' privacy in question asking; c) Rewarding the effort asking questions; d) Setting one goal for the task (understanding

unfamiliar chemical phenomena to explain them in another class to other subjects that don't not know them and that, in order to do so, they could ask all the questions they deemed necessary to understand the phenomena). Two chemical phenomena were adapted to fulfil the following characteristics:

- Operating procedures must be basic and simple.
- They must generate perplexity by presenting events that contrast with expectations (unknown or contradictory to what most students and experts expect). In chemistry education, we are more familiar with chemical changes that imply, for example, only one colour change or the formation of a precipitate, but we don't expect reactions that oscillate between various colors.
- The chemistry concepts the device refers to "chemical change" should have been addressed in previous years.

The chemical phenomena were:

- "*The blue bottle experiment*". A colorless solution in a flask is shaken for a few seconds until the liquid turns blue. Upon standing for a short period of time, the solution goes clear again. The process can be repeated for over 20 cycles.
- "*Mysterious Cloudiness*". A cloudy white colour appearing when we blow through a straw into a glass with colourless liquid (dissolution of calcium hydroxide), but disappearing if we continue blowing.

### **Subjects**

In this study participated 65 high-school students (31 10<sup>th</sup> grade and 34 12<sup>th</sup> grade students), 19 secondary pre-service teachers and 10 chemical experts (researchers in analytical chemistry).

*Variables and Measurements:* Under the assumption of ISQ (Information Seeking Questions) came from failed inferences, we adapted the taxonomy of inferences proposed by Trabasso and Magliano [17] to analyze the questions asked by subjects:

- T1: Questions addressed to know the entities (objects or events), their properties or characteristics. The usual expressions are "*What, When, Where...*"
- T2: Addressed to justify objects or events (causality). They are usually expressed as "*Why*" questions.
- T3: Addressed to anticipate future events, consequences or what would happen if things were different.

### **Results and Discussion**

As can be seen from Table 1, the most pronounced similitude between the questions asked by students, pre-service teachers and experts is their special interest in identifying the types of substances involved in the chemical phenomena. What differs are the conditions under which specific strategies and representations are manifested in their questions. Experts ask high-level questions that involve a variety of inferences and representations base on the underlying principles of the domain. Therefore, experts generated ask significantly more questions addressed to the scientific model construction than pre-service teacher and students.

The results suggested that questions are asked when students, pre-service teachers and experts lack knowledge about chemical phenomena. Such inferences are made to try to learn more about the chemical substances (*Which substances or compounds are these?*), justify their changes (causally, for example: *Why it change color?*). Nevertheless, the students do not ask questions about the conditions under which chemical reactions occur. Clearly this result is very worrying when the majority of pre-service teachers do not make inferences on the conditions under which the chemical change occurs.

Table 1: Frequently asked questions about unfamiliar chemical phenomena

Subjects	Kind Question	Freq. (%)	Questions
Students 10 <sup>th</sup>	T-1	20,4	Which substance is this?
	T-2	19,9	Why it change color?
	T-3	2,6	Do I need to stir for it turns blue again?
Students 12 <sup>th</sup>	T-1	20,6	Which substances or compounds are these?
		6,8	Which reaction is occurring?
	T-2	13,5	Why when I stir it, it changes color? What is happening?
	T-3	3,2	If I stir the bottle, ¿Will it returns the color again? And if I let it rest, ¿Will it returns transparent?
1,8		The amount of these reagents that I should use, is important or not?	
Pre-service Teachers	T-1	22,7	Which reagents are we using?
	T-2	7,8	What kind of reaction is occurring here? Is it an acid-base reaction? Cyclic reaction?
		7,1	The CO <sub>2</sub> that I exhale reacts with the content of test tube and this precipitate is formed?
	T-3	3,2	Can I measure the pH of the reagents? Dissolutions too, so I can know its nature: acid or basic.
		2,6	Would influence in the results, the specific amount of water and reagents that are you adding?
Experts	T-1	19,1	Which reagents are we using?
		19,1	What kind indicator are we using? ¿Is a pH indicator? ¿Is a Redox indicator?
	T-2	15,5	What happens here, does it change colour if I shake it? When we mix it with the indicator and then we shake it, it turns blue. Could be that Oxygen is oxidizing to a compound into the bottle causing the indicator is blue? When the bottle isn't shaken, there isn't exchange of oxygen, so the reaction could be a reduction reaction ... I think so.
	T-3	15,5	I need to use the analytical method to study the reagents we are using. So I could know the characteristics of the reagents, which cations or anions there are, its pH, etc.

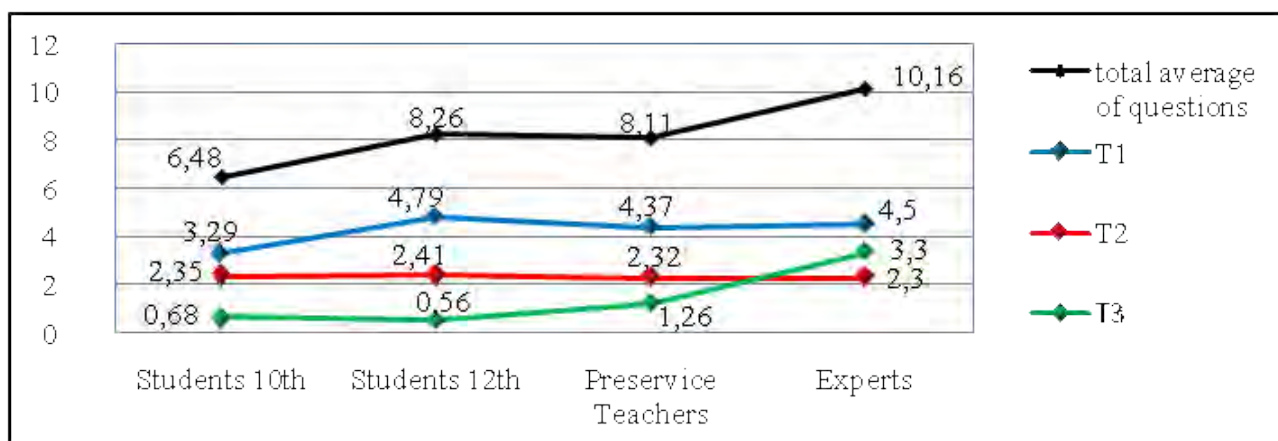


Figure 1: Average number of questions asked per each groups

According to Figure 1, the procedure and strategies used generated a relevant and significant amount of questions (between 6,48 and 8,26 questions per student in 12 minutes). These considerable amounts can be compared to 1 question in 6-7 hours reported by Graesser and Person [18].

## Conclusions

Most of the obstacles to understanding that caused subjects to ask questions stemmed from attempted inferences that had not been achieved. Such inferences are made to try to learn more about the entities, justify them (causally) or anticipate them, which also refers to the scientific skills that teachers wish their students to develop: describe the material and the phenomena, find increasingly general causes, that may become laws and predict events on the basis of that causality (of laws).

If the appropriate conditions are provided, unfamiliar chemical phenomena are capable of provoking a significant cognitive (inferences) and metacognitive (comprehension control) effort in the students themselves, which could be used as a starting point for well-motivated learning by research.

## Bibliography

1. Roca, M., Doctoral dissertation, Universitat Autònoma de Barcelona. Spain 2007,
2. Rosenshine, B., Meister, C. and Chapman, S., *Review of Educational Research*, 1996, 66 (2), 181-221.
3. Van der Meij, J.H., *Learning and Individual Differences*, 1994, 6 (2), 137-161.
4. Flammer, A., *Psychological Research*, 1981, 43 (4), 407-420.
5. Gavelek, J., Raphael, T., Metacognition, instruction and the role of questioning activities. In G. M. D.L. Forrest-Pressley, *Metacognition, cognition and human performance*, Vol. 2, Academic Press, Orlando: FL 1985, pp. 103-136.
6. Chin C., Osborne, J., *Studies in Science Education*, 2008, 44 (1), 1-39.
7. Chin, C., *Journal of Research in Science Teaching*, 2007, 44 (6), 815-843.
8. Lawson, A., *Science Teaching and Development of Thinking*. Wadsworth-Thomson Learning, Belmont: CA 1995.
9. Brookfield, 1986, cited by López & Recio, *Creatividad y pensamiento crítico*. Mexico: Trillas, 1998.
10. Bachelard. G. *La Formation de L'esprit Scientifique. Contribution a une psychanalyse de la connaissance objective*. Librairie Philosophique J. Vrin, Paris 1960, p. 14.
11. Dillon, J.T., *Journal of Curriculum Studies*, 1988, 20 (3), 197-210.
12. McComas, W.F. and L. Abraham: Asking More Effective Questions, [http://cet.usc.edu/resources/teaching\\_learning/docs/Asking\\_Better\\_Questions.pdf](http://cet.usc.edu/resources/teaching_learning/docs/Asking_Better_Questions.pdf), Accessed 19 January 2012.
13. Otero, J., Question Generation and Anomaly Detection in Texts. En J. D. D. Hacker, *Handbook of Metacognition in Education*, Routledge, New York: NY 2009, pp. 47-59.
14. Otero, J., Ishiwa, K., Caldeira, H., Macias, A., Maturano, C. and Sanjose, V., 1st International Seminar on Research on Questioning. University of Aveiro, Portugal, 2004.
15. Otero, J., Graesser, A., *Cognition and Instruction*, 2001, 19 (2), 143-175.
16. Costa, J., Caldeira, H., Gallástegui, J.H. and Otero, J., *Journal of Research in Science Teaching*, 2000, 37 (6), 602-614.
17. Trabasso, T., Magliano, J., *Discourse Processes*, 1996, 21 (3), 255-287.
18. Graesser, A., Person, N., *American Educational Research Journal*, 1994, 31 (1), 104-137.

## Density and Hot Air Balloons: contextualized didactic proposal in STSE curriculum

Marina Vieira SANTOS; Márcia Regina CORDEIRO; Keila BOSSOLANI KIILL

*Federal University of Alfenas, Institute of Chemistry 700 Gabriel Monteiro da Silva St.*

*Zip-Code 37130-000- Alfenas-MG, Brazil*

*Phone: 55(35)3299-1000, Fax: 55 (35)3299-1063*

*Marina Vieira Santos*

*Phone: 55 35 91585669 and 55 35 37219945*

*E-mail: marinavieira.santos@gmail.com*

### Abstract

*Studies show the importance of showing students that Chemistry leads to the understanding of daily-life phenomena. While teaching Chemistry contents, it is essential to establish the teaching-and-learning process on the approach for Science, Technology, Society, and Environment (STSE), aiming to development of student citizenship. The objective of this study was to plan and elaborate a contextualized didactic proposal for the teaching of the concept of density, considering experimentation as form of discussion of this subject. Through this proposal, the knowledge of science becomes interesting to the student and he understands its implications in daily life, being able to improve his formation as citizen and empower himself to take decisions on a personal and social dimension.*

**Keywords:** Density, didactic proposal, experimentation, contextualization

### Introduction

In Brazil, the density content is taught to students on the elementary school (14 years old) on science class and for high school students (15 years old) on chemistry classes. The chemistry content on the majority of Brazilian schools is worked on a decontextualized way, the technologic, social and environmental aspects are not considered [1]. Many times, to learn chemistry contents is about memorize complex names, solve problems by algorithms and classify chemistry phenomena. To avoid giving the students the idea that science doesn't concern about the society problems, and that scientists are just interested in create theories and make new discoveries, a contextualized teaching of real world is inquired, showing that the discussion about scientific concepts is for everyone. Thus, in order to break this teaching model, we look for a contextualized approach to the density concept. On this way, the teacher works in the classroom a theme that is known by the students, relating this theme to the content and the real life [2] which shows students the importance and relevance of science for themselves and for the society [3]. It is important in this understanding of chemistry teaching that the context is not a mere motivational trick in the beginning to lure the students into the chemistry. The context is the thread along which the investigation of the issue in question develops. It begins with the learners' prior knowledge and experience, it is guided significantly by their questions and interest and it is linked to as many real world experiences as possible [4]. Beyond that, through the contextualizing is necessary to substantiate the teaching and learning process, looking for an linking between the science and technology and the social context [5]. By focusing STSE (Science, Technology, Society and Environment) teachers and students begin to discover, search together, to build and make scientific knowledge. So, student and teacher innovate the knowledge structure, breaking with the traditional conception that predominates on the school, and as a consequence, promote a new way to understand the production of knowledge. In other words, is intended to educate the students like citizens and enable them to take their own decisions about science and technological questions and its interactions with the environment [6-7]. To the content of density, too many students believe that it is just the result of the arithmetic operation of dividing mass by volume. This makes density an abstraction and prevents them from relate it with other phenomena, making it just a mathematic rela-

tion. Usually, in the end-of-chapter there are, almost exclusively, questions about  $d=m/V$ , this way they don't realize the meaning of the numeric value of density of a compound. However, the understanding of the density concept is so important such is the calculation or measuring. [8]

### Objective

The main objective of this work was to develop a sequence of learning activities to the concept of density, considering the different types of balloon as the main theme to the developing of the experimental activities.

### Methods

This didactic contextualized proposal was elaborated in collaboration with high school teachers from public schools in the city of Alfenas, Brazil, they are members of the In-service training program for chemistry Teachers (ProFoQui/UNIFAL-MG).

At first, discussions were performed in meetings at the University, which were exposed the most difficult subject for teachers to teach and especially the realization of experimental activities. So, a material was elaborated to answer the teacher's needs according to the reality of their routines. The steps of the elaboration of this material were: (a.) Identification of content difficult to understand, by students of the first year of high school; (b.) Picking a theme and experiment for discussion and contextualizing; (c.) Elaboration of pedagogic procedure and teaching activities that consider situations and materials known by students; (d.) Planning the guide-book of pedagogical mediation and (e.) Application of the material with public schools students. For this, we tried to recover what has been studied on the chosen topic through a literature review and involve it in experimental activities. Given this, it explores the student's previous knowledge about the context correlating it with the content of chemistry.

### Results

While in traditional teaching, the curriculum is divided into subjects (Chemistry, Physics, Biology, etc.), STSE approach in teaching is divided into technological and social issues, dealing with real problems and not isolated and emphasizing the experimental activity. Considering this approach, the material presented includes density content and contemplates as central theme the balloons. Through the chosen theme, is able to work many chemical contents, and realize the interdisciplinary with contents of physics (strength, counter-attraction and weight), biology, (studying the constituents materials of hot air balloons, like the wicker basket, the wood taken from *Salix* trees), Geography (when studying the weather balloon and its functions) and Math (graphic construction, on the last experimental activity of the material); and work the environmental problems questions, caused by the use of regular São João balloons from Brazilian festivals.

A detailed study of the hot air balloon showed us from its history to its operation, explained by differences in the density of hot air and cold air. This context will may submit an immense new for the student: flying balloon is simple and very easy, doesn't carries risks as many should think. He may also know every component of its structure, how and why the choice of each material and mainly what makes it work (ascension). Within this context, the student can understand the concept of density and see how the course content can articulate to explain the workings of the balloons.

The material is divided into four modules: module I that intends to lead students to understand the concept of density through activities that involve the concepts of mass and volume (figure 1). Module II contextualizes the chemical knowledge through the subject "The rise and fall of the balloons," at this time the student should represent trough painting some balloons and show its knowing about them and the teacher can work the characterization of the materials that compound the hot air balloons, approaching the concept of polymer (nylon e Kevlar®), studies of metals (cylinders of fuel) and each part of the balloon. This module will present the different types of balloons, the materials they contain and the evolution of materials in relation to hot air balloon. In this activity it's important the student realize the role of chemistry in technological development, and also the complex relationship between science and techno-

logy throughout history, as well as the evolution of materials and products at different times with the inclusion of new technologies come from human elaborations [9]. Given this, it is necessary to induce the student to think about the evolution of materials used in a hot air balloon and mainly on the development of its operation, size and shape, considering how little scientific knowledge that had before. This module provides explanations for the operation of the hot air balloon guided by the difference of density between hot and cold air and also performs the experiment on density of solids (figure 2). Module three brings the activity "the movement of the balloons," made of paper balloons. At this time there are two balloons made of paper in a support and a candle is engaged in one of the balloons, showing how the hot air influences in its ascension (figure 3). Module four's topic is "The chemical concepts explained," and it brings a text that uses the concept of density to understand the workings of the balloons. In the material, there are three attachments with important information about the balloons: description, operation and image of each balloon, specifying each component of its and the invention history. And finally there is an experimental activity whose goal is to calculate the density of liquids. The instrument used is a densimeter, the same that is used on Brazilian gas station, however construct with common materials - soda straw, nails and sealing tape (figure 4).

### Concept Mapping of the proposal

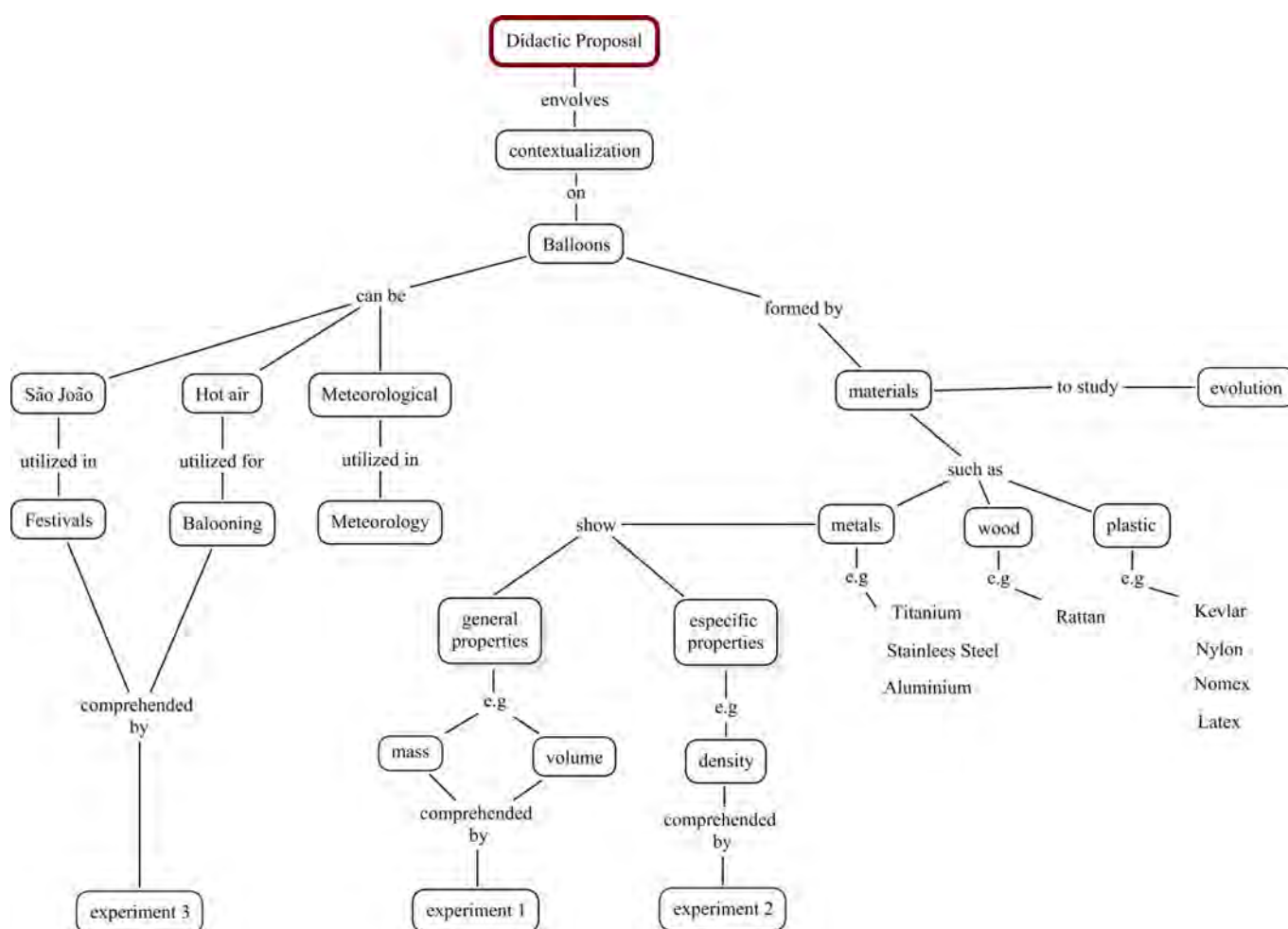


Figura 1 Concept mapping



## STSE approach of proposal

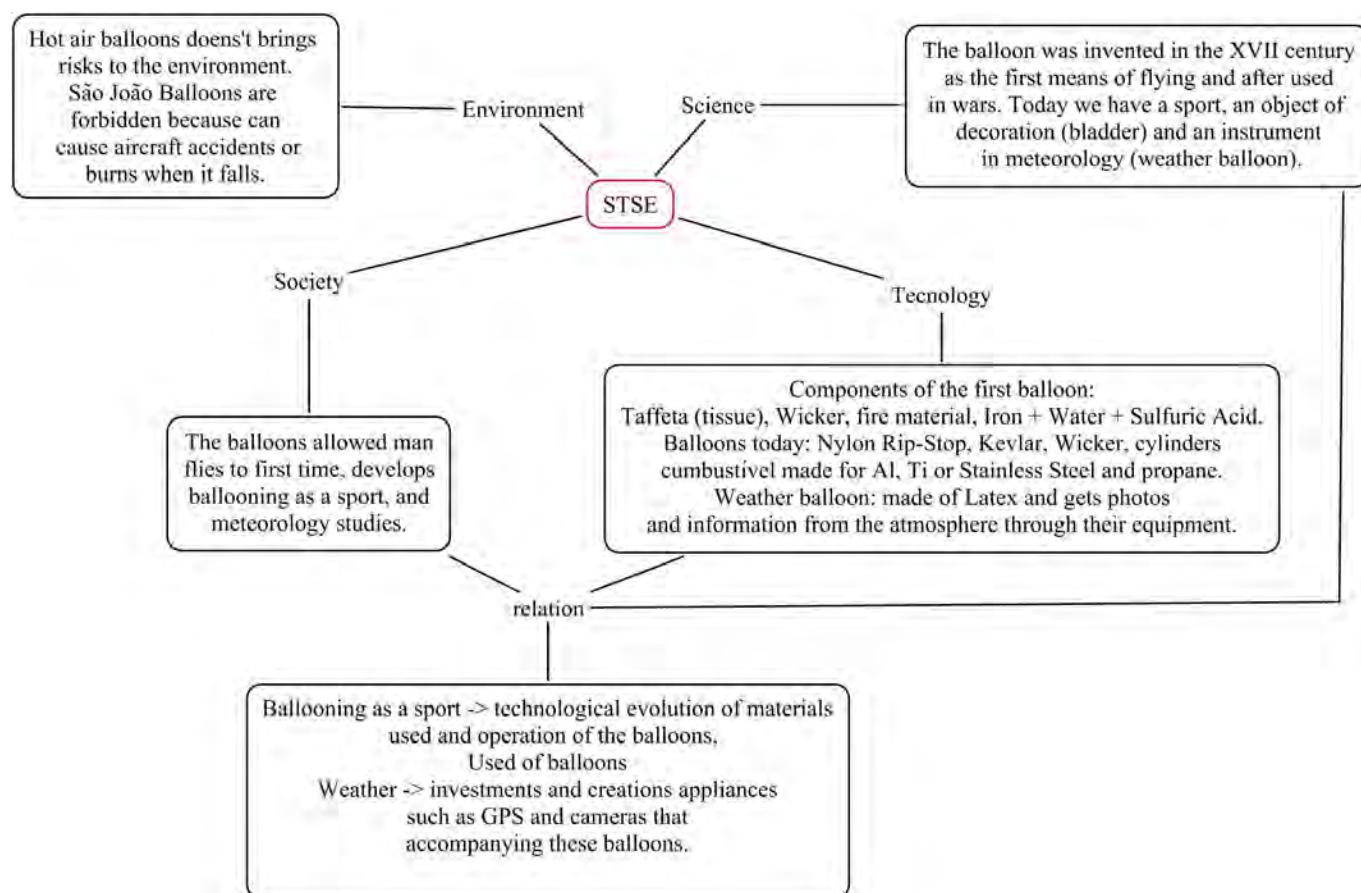


Figure 2 Diagram of STSE approach of the material

## Materials Used on experimental activities

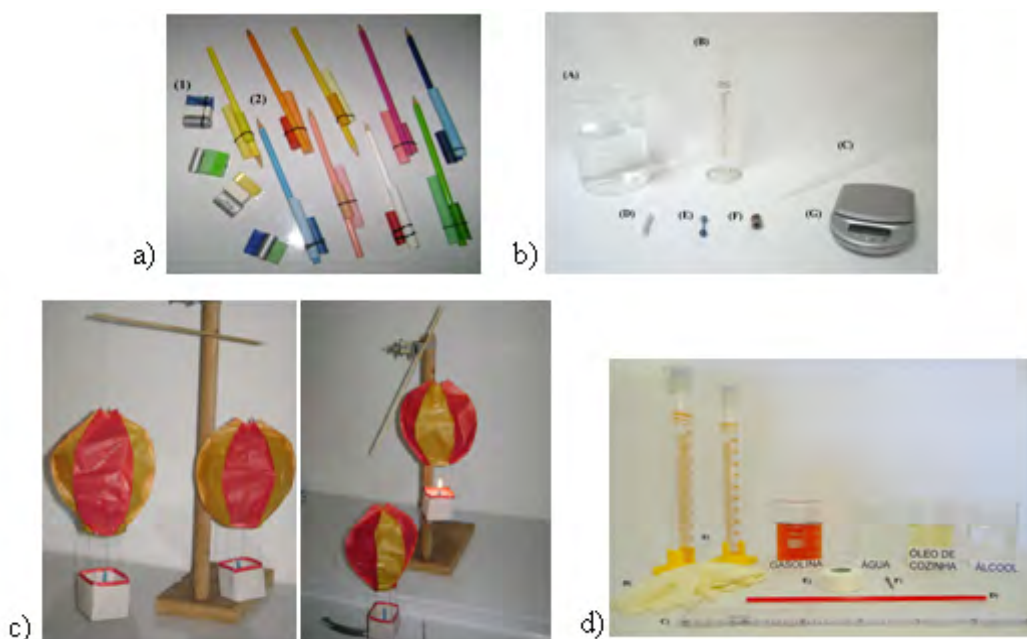


Figure 3 a) Module I: Mass and Volume; b) Module II: Density of solids; c) Module III: Moviment of balloons; d) Module IV: Density of liquids

## Conclusion

It was clear that the concept of density is extremely hard to be understood by the students and through this proposal they could study, during 5 lessons, different situations involving this concept. It was drawn to conclusion that the subject is proper for the teaching of density, allowing to be contextualized, and that discussing the experiment may contribute to the formation of participative students in society.

## Acknowledgment

Thanks to University Federal of Alfenas and Programa de Formação Continuada para Professores de Química (ProFoQui – Unifal).

## References

- [1]Ricardo, E.C., *Ciência & Ensino*, 2007, vol. 1, número especial.
- [2]Rioseco, M.G., Romero, R. *Paideia: Revista de Educacion*, 2000, vol. 28, 35-63.
- [3] Ika Parchmann, Markus Luecken, *International Seminar, Professional Reflections*, National Science Learning Centre, York, February, 2010, 1-15.
- [4]Nentwig, P. M. , Demuth, R., Parchmann, I., Gräsel, C., Ralle, B. *Journal of Chemical Education*, 2007, vol. 84 (9),1439-1444.
- [5]Vieira T. C., Magalhães S.I.R., *Revista Portuguesa de Educação*, 2006, vol. 19(2), 85-110.
- [6] Solbes, J., Vilches, Amparo, *Enseñanza de las Ciencias* , 2004, vol. 22(3), 337–348.
- [7]Solbes, J.,Rios, E.,*Revista Electrónica de Enseñanza de las Ciencias*,2007, vol. 6(1)
- [8]Hawkes, S.J.,*Journal of Chemical Education* , 2004, Vol. 81(1),14-15.
- [9] Brasil, Ministério da Educação, Secretaria de Educação Média e Tecnológica. *Parâmetros Curriculares Nacionais: Ensino Médio*, 2011.

## The greening of the chemistry curriculum: international cooperation “Belarus-V4 countries”

Tatsiana SAVITSKAYA, Iryna KIMLENKA, Aliaksandr RYTAU

*Belarusian State University, Nezavisimosti ave., 4, 220030 Minsk, Belarus  
E-mail: savitskayata@bsu.by, Tel/Fax +375 17 209 55 44*

### Abstract

*The chemistry curriculum focused on teaching students to view chemistry with a green tint is discussed. To meet requirements for the Third Generation University the new Green Chemistry course has been proposed for the students who wish to combine state-of-the-art research in chemistry with environmental awareness.*

**Keywords:** Green Chemistry, the Third Generation University

Universities are changing in a fundamental way, moving from the model of the science-based university into the Third Generation University or 3GU for short [1]. 3GUs actively collaborate with industry, financiers and other universities via their know-how hub. Universities operate in an international competitive market and they are experimenting with new forms. In this situation university curriculum is undergoing major changes and developments.

Chemistry is assigned to those natural sciences which make up the basis of the university education.

Mankind has been awarded long ago the inextricable link between the benefit and harm that chemistry causes for environment and human health. The considerable chemical contamination takes place in many of the large industrial areas. The substantial funds spend on the reduction for the waste treatment plants creation and harmful substances recovery. The solution of the environmental problems at the end of the industrial cycle is named the “end of pipe” approach. Along with this approach the so called “preliminary approach” is considered increasingly. It is focused on the prevention of the reasons but not on the removal of the consequences of the environmental conditions deterioration. In practice the precautionary approach includes the optimization of the production processes, the energy-efficient technologies application, the sampling of the ecologically pure raw materials and new design of the products, internal and external recycling of wastes, reduction of toxic and harmful substances usage. This approach promoted the development of the new direction in chemistry which has been called “green chemistry”.

Today the chemists call “a green chemistry” any improvement of the chemical processes that influences on the environment positively. There are three main directions of the green chemistry development including new methods of synthesis, the replacement of the traditional solvents by safety solvents and the usage of the renewable resources instead of oil [2-4]. Green synthesis is carried out under unconventional conditions kipping off high temperatures and pressures with the use microwave radiation, ultraviolet radiation, mechanical activation, ultrasound and new design of the reactors. Green reagents, for example, dinitrogen peroxide – green oxidizer, are used as well. Catalytic reactions are widely used for the green chemistry goals. Supercritical fluids are used as the alternative to the conventional solvents. The usage of the biomass instead of oil for hydrocarbons feedstock and fuel production is one more way to the achievement of green chemistry goals.

However, nowadays the ideas of green chemistry exceeds the limits of chemistry itself and widespread for the different fields of science. Green chemistry is a revolutionary philosophy.

It was being recognized by chemists that there had to be mutual understanding and collaboration between the players involved in chemical production and representatives from all the social categories concerned with safeguarding the environment and human health. It appeared clear that the existing gap could be bridged best by young chemists able to redesign chemical production so it was safe, environmentally friendly, socially acceptable, and profitable. To meet this goal it is essential that students are taught to view chemistry with a green tint. The first lecture course on Green chemistry was delivered at the Nottingham University (Great Britain) for chemistry and engineer students. Currently Green chemistry is taught at many universities all over the world.

To meet changing industry and society requirements the course "Introduction to Green Chemistry" has been proposed as an obligatory for the greening of the chemistry curriculum in the Belarusian State University. The course became reality in 2009. Our teaching experience convinced us of the fact that the introduction of such course into the educational process create the necessary prerequisites for the improvement of chemical education in the higher school. The success of the course is judged by the large amount of positive feedback from our students. Most of students believe that green chemistry does not spend time on weighting for the pros and cons, it finds principle solutions of the problems, forces to think and change a lot by now for the bright future.

Throughout our education experiment the course "Introduction to Green Chemistry: Belarus and V4 countries" has been proposed in 2012. The aim of designed course is acquainting students with the green technologies and the international activities in this new field of the chemical knowledge with emphasis on Belarus and V4 countries. The course provides a close collaboration with industry and universities of V4 countries by inviting specialists and field trips organization. So, the main feature of the new course is the International staff (Belarus, Poland, Hungary and Czech Republic) and Industry Representative ("BASF SE"- Belarus). It is a unique opportunity to bring together a number of experts in the field of Green Chemistry and students interested in this topic.

The material of the program gives the clear view of this new field of the chemical knowledge in its' contemporary state. The special attention is paid to the universal role of green chemistry in the individual development of the chemical disciplines. In addition the importance of green chemistry is demonstrated for the development of other natural sciences and humanities sciences as well. The program of the course has been designed by the specialists in the field of chemistry, ecology, labor protection and humanities sciences. It is the incarnation of the interdisciplinary communication principle. It is important for the training of specialists which are able to integrate the ideas from the different fields of science, to use the interdisciplinary categories, and to take in the innovation process in the manner of integrated approach. The modular principle of the material organization corresponds to the tendencies of the harmonization of the educational process with European tendencies. The contents of teaching material are presented in Table 1. Some examples of seminars are presented in Table 2. The format of teaching materials balances lectures with time for discussion between instructors and students and socialization. The analysis of the inorganic and organic chemistry labs curriculum for green contents will be hold by the students of the faculty. The competition will be announced for the progressive substitution of the most dangerous chemicals when suitable alternatives have been identified.

Special attention is noticed to the perspectives and challenges of green nanotechnology in the frame of the course. One of the most fundamental challenges particular to green nanotechnology is that the science, the testing, the regulatory strategy, and even the processes needed for commercial production are all being developed and deployed at the same time. From this central challenge flow many early stage challenges that will discussed during the seminars. The new hazards introduced by nanotechnology and lack of appropriate policies to manage any new risk in the connection with nanotoxicology will be reviewed as well.

Thereby the international cooperation with universities and industry in the frame of the course "Introduction to Green Chemistry: Belarus and V4 countries" will create special facilities to meet requirements for 3G University.

**Table 1.** Contents of teaching material

Module	Main Topics
1. «Green Chemistry» – Chemistry for Sustainable Development	«Green Chemistry» as a science and ideology. Sustainable Development Concept and Green Chemistry. Toxicology basics and ecological risk. Legislation and Controlling Environmental Performance. Knowledge Management in postindustrial period.
2. Directions of green chemistry development	Chemical Synthesis and Green Chemistry. Alternative methods of chemical reaction activation. Catalysis and Green Chemistry. Green Design of Chemical Processes. Green Solvents. Renewable Resources. Green Chemistry in Belarus and V4 Countries.

**Table 2.** Seminars examples

Topic	Questions for discussion and tasks
Ecological management and safe handling of chemical substances	Environmental Management Systems: ISO 14001, European Eco-management and Audit Scheme (EMAS). EMS in the world, V4 countries and Belarus. REACH principles and goals. REACH documents. OSOR concept. Eco-labeling. 1. List at least three driving forces to be required for EMS in case of: a) State, b) Company, c) Consumer. 2. What does each of EMS types mean: <ul style="list-style-type: none"> <li>• Environmentally Passive</li> <li>• Steered by the Authorities</li> <li>• Demand Optimizing</li> <li>• Environmentally aware</li> <li>• Environmentally adapted</li> </ul> What is the most acceptable in modern society? 3. Give some examples of chemical and petrochemical enterprises certified according to ISO 14001, including Belarus and V4 countries. Are there cases in any countries when enterprises rejected EMS? 4. What does REACH and OSOR mean? Analyze where and when REACH is used and attitude of different countries to REACH reforms including V4 countries and Belarus. 5. List driving forces and obstacles for REACH introduction.
World experience in introduction of green technology in industry	National and international projects in green chemistry area. Activity of Vishegrad countries (Poland, Czech Republic, Hungary and Slovak) and Belarus as an example of introduction of green chemistry principles. New developments of Belarusian scientists: biobutanol production, non-carbon bisulfide process of hydrated cellulose fiber production etc.

### Acknowledgments

The authors gratefully acknowledge the International Visegrad Fund ([www.visegradfund.org](http://www.visegradfund.org)) for the financial support for the development of the course “Introduction to Green Chemistry: Belarus and V4 countries”.

### Reference List

1. J. G. Wissema, *Towards the Third University Generation: Managing the University in Transition*, Edward Elgar Publishing 2009.
2. M. Lancaster, *Green Chemistry: an Introductory Text*, Royal Society of Chemistry, New York 2002.
3. P. Tundo, A. Peroso, F. Zecchini, *Methods and Reagents for Green Chemistry*, Wiley, New Jersey 2007.
4. P. Tundo, V. Esposito, *Green Chemical Reactions*, Springer 2008.

## International year of chemistry events at the Belarusian state university

Tatsiana SAVITSKAYA<sup>1</sup>, Iryna KIMLENKA<sup>1</sup>, Olga MOSEJTSCHUK<sup>2</sup>,  
Dzmitry GRINSHPAN<sup>1</sup>, Ivan REZNIKOV<sup>1</sup>

<sup>1</sup> Belarusian State University, Nezavisimosti ave., 4, 220030 Minsk, Belarus

<sup>2</sup>BASF Representative Office in Belarus, 1<sup>st</sup> Zagorodnij lane, 20, 220073 Minsk, Belarus

E-mail: savitskayata@bsu.by, Tel/Fax +375 17 209 55 44

### Abstract

*The International Year of Chemistry main events at the Belarusian State University are discussed. The Faculty of Chemistry has hold Master class for secondary school teachers to draw the students for participation in the Global Experiment. The book "Nuclear Chemistry: improving professional skills in English" devoted to the 100<sup>th</sup> anniversary of the Nobel Prize award to Marie Sklodowska-Curie has been published.*

**Keywords:** The Global Experiment, Master-class, Nuclear Chemistry

The International Union of Pure and Applied Chemistry announced 2011 the International Year of Chemistry, pronouncing its motto as "Chemistry is our life and our future". This was the year when the Belarusian State University hallmarked its 90<sup>th</sup> anniversary and 80<sup>th</sup> anniversary of the Faculty of Chemistry. The Global Experiment addressed to chemical solutions of water issues was specified by us as one of the main events of IYC. The Faculty of Chemistry and BASF Representative Office in Belarus held the Master-class to help the teachers of secondary schools to encourage pupils for participation in the Global Experiment. The great attention to water problems was not occasional because the Faculty of Chemistry accents the importance of water issues and the participation of the young people in the solving of water problems.

The Belarusian State University (BSU), founded in 1921, is the main educational and scientific establishment in the Republic of Belarus. It includes 17 faculties, 3 scientific research institutes, 5 national scientific centers, and 14 unitary scientific and production enterprises. It admits more than 24.000 students majoring in 57 subjects with fundamental sciences being the top priority.

The Faculty of Chemistry was opened in 1931. There are 8 Departments, 6 Scientific Research Laboratories, about 650 students at the faculty. 190 members on staff including more than 92 lecturers, 18 doctors of science, 55 candidates of science (PhD), 1 academician, and 1 corresponding member of the National Academy of Sciences of Belarus are involved in the learning process. Faculty of Chemistry is the only establishment in Belarus to give students the diploma in Chemistry. It works in close contact with the Scientific Research Institute for Physical and Chemical Problems, which originally stemmed from the Faculty itself, but later separated in 1978. Many students are engaged in scientific research thanks to the support of the Institute.

Belarus is rich in water resources and known as a country of blue lakes. We can be proud that we have a lot of clean fresh water. There are 20800 rivers, 10800 lakes and more than 5000 bogs in Belarus. The major task in the field of education for solving the water issues is the association of teachers and scientists to raise awareness of the young generation about the water resources protection. The experts of the Scientific Research Institute for Physical and Chemical Problems and the Belarusian State University are famous in Belarus and in some other countries (Russia, Germany, Korea and China) by their new solutions of the water treatment problems. They have offered the new technology for water treatment to improve drinking water quality. It can be implemented on the scale of large cities at the water treatment plants and at small settlements as well. In cases of emergencies an independent mobile autonomous water treatment plant or portable individual water treatment kit can be used. The high level of the water treat-

ment research has become the background for the creation of the new tradition for annually Youth Forums holding. The Youth Educational Forum «From a decade of clean water to a century of healthy life» on March, 26th, 2008 was the first. The interest of the chemical community members (teachers, students and researchers) in water treatment is quite natural. Chemists can successfully pollute water; they also should clear it by means of new highly effective technologies.

Then there were “Water, climate change and human health” (2009), “World of water technologies” (2010, 2011) Forums at the Faculty of Chemistry. The cooperation with the authoritative international organization like Central European Initiative facilitated to the success of the events. The long-standing partners of the chemists are the United Nations in Belarus, National Center of the Baltic University Programme, Scientific Research Institute for Physical and Chemical Problems and the government organizations including Ministry of Foreign Affairs, Ministry of Education, Belarusian Republic Fund of the Fundamental Research, State Committee for Science and Technologies, Department for Hydrometeorology of the Ministry of Natural Resources and Environmental Protection, Exhibition Company “Expoforum”. The rising of the awareness of the young generation on the issues of the pollution and the protection of water resources; the stimulation of young people for the active scientific efforts, generation of the sustainable interest in water technologies development and the assistance in training qualified scientists who can solve professional tasks and promote water knowledge among various strata of society were the main goals of the Forums. The United Nations Organization actions on preservation of global water resources, the situation with surface and underground waters in Belarus, the biological mechanisms of water quality formation, the conformity of drinking and bottled waters quality to national and international standards, new technologies for water treatment, educational aspects and so on were on the agenda of the Forums.

The focus on youth is explained by the fact that mission of the world, humanism and sustainable development propaganda in a society is intended for young generation. Regular youth forums are the part of the complex educational program of the Belarusian State University. The feature of the Forums is the joint participation of the academicians and students in the Forums sessions. The dialogues and even discussions help students to form the skills of the scientific communication. Another result of the forums is the participation of the students in the study of not only the water treatment procedures but in the fundamental research. For example, quantum-chemical calculations of the water structure have been made for different aggregate state of water.

When the Global Experiment started in 2011 year announced by UN by the initiative of IUPAC as the International Year of Chemistry, the Faculty of Chemistry made a decision to help secondary school teachers. School students around the world were invited to explore one of Earth’s most critical resources, water. The results of their investigations were contributed to a Global Experiment, which has become the biggest chemistry experiment ever. The Belarusian State University held the Master-class “Global Experiment in the Republic of Belarus” for school teachers. More than 150 teachers took part in this event.

Undergraduates and master students performed all the experiments proposed by the Global Experiment and prepared the presentations with the explanation. There were four presentations: pH of the Planet; Water: No Dirt, No Germs; Salinity of Water and Solar Distiller. All students reported for their own results and the theory background. The participants of the Master-class were impressed by the demonstration of the dirty water treatment with the help of the new technologies developed by the researchers of the Belarusian State University under the participation of the faculty of Chemistry students. The BASF Representative Office in Belarus promoted the development of the idea of Master-class and sponsored the event. Special website, on-line map of Belarusian water resources pH were created, new data for water structure were obtained [1-3]. It’s a pity that the number of the secondary school students examined pH and made other tasks was not very large. The event drew the attention of the young people to the general vision of the international challenges of water use and protection. The discussion of the future trends and priorities of international cooperation in the activity for water protection looks very useful. We hope that it was a step and introduction to the continuous education system on water problem and use.



Along with the Master-class “Global Experiment in the Republic of Belarus” there were some more events in the kaleidoscope of the International Year of Chemistry activity:

- Festival of Chemistry with the demonstration experiment for school students, May
- Annual Olympiad “Oxygen 2011”, July
- Science History Days, September
- Publication of the book “Nuclear Chemistry: improving professional skills in English”, October.

As for the Science History Days it is an annual event. In 2011 it was the fifth anniversary the Days. The Days have become a well-established tradition. In IYC it was devoted to the famous organic chemists A. Butlerov, Ye. Vagner and N. Prilezhaev. That year the world scientific community celebrated the development of Butlerov’s theory of the chemical structure of the organic compounds. Alexander Butlerov was one of the outstanding Russian chemists, known public figure, and science popularizer. Butlerov contributed to the development of the experimental and industrial chemistry. For reference: Nikolai Prilezhaev was one of the first deans of the Faculty of Chemistry from 1924 till 1934. We attach importance to the close connection of the classic chemistry and modern directions of the classic theories development. We are firmly convinced that the biographies of great scientists are the educational incentive for young students. There was the report “Nobel Prize Winners in the Field of Chemistry at the Last Decade” as well. All Nobel prizes in chemistry, the youngest chemistry laureates and the most important Nobel laureates in chemistry were mentioned.

IYC also celebrated 100<sup>th</sup> anniversary of the Nobel Prize award to Marie Sklodowska-Curie. Belarus is a newcomer country in the nuclear energy area. Taking into account that nuclear science as an interdisciplinary field requires the cross-cultural relations and the communication expertise of the English language, the language of international exchange and knowledge transfer, the BSU lectures put forward the book “Nuclear Chemistry: improving professional skills in English”. The book was devoted to IYC. A book like this one is in the unique position of being simultaneously “advanced” and “introductory”. It is advanced in the sense of building on grammar and lexical rules as well as collocations important for non-native speakers of English and introductory in the way as acquainting students with the scope of Nuclear Chemistry.

There are many fine textbooks on nuclear, radio- and radioanalytical chemistry. So the question can be raised as to why we would write another textbook on nuclear chemistry. For all of us non-native speakers to learn English has been a challenge at a certain point in our lives. It is said that chemists, engineers, lawyers, philologists speak in a different language from the rest of society. For us who practice the chemical sciences the learning of chemical English has typically been “a learning on a job” experience.

The discovery of radioactivity a century ago opened up a new field “nuclear science”. Nowadays Nuclear English is the most demanding English not only for specialists but also for society since there is a large, growing, and vital community of people who use the applications of nuclear science to tackle a wide-ranging set of problems in medicine, engineering and other fields of our life. Probably that was the reason why we began to write textbook “Nuclear Chemistry: improving professional skills in English”.

In this book we have tried to be as comprehensive as possible. We have attempted to present nuclear chemistry and the associated applications at a level suitable for an undergraduate student. Our aim is to convey the essence of the ideas and the blend of theory and experiment that characterizes nuclear chemistry. Our hope is that the reader can use this book for an introductory treatment of the subject and can use the end-of-unit references as a guide to more advanced and detailed presentations.

We really hope this book as a quick refresher course will be also helpful to professionals working within the realm of nuclear science who are non-native English speakers. This would include not only nuclear chemists, either trained or in training but also technologists, engineers, physicists, basic scientists.

In the frame of the IYC events the Chemistry Olympiad of the Faculty of Chemistry was held also. The BASF Representative Office in Belarus was the sponsor of the Olympiad. The Chemistry Olympiad was named OXYGEN 2011 and its program aimed to: stimulate students to achieve excellence in chemistry; recognize outstanding chemistry students and, in doing so, encourage additional learning at a formative

time in their intellectual development. The organizers are confirmed that the Olympiad is necessary for talented students in so manner as oxygen is necessary for breathing.

Summing the activity in the International Year of Chemistry we note with satisfaction that the enthusiasm of students, professors, researchers of the Belarusian State University, the contribution of BASF Representative Office in Belarus promoted an awareness of the importance of chemistry for Belarus sustainable development, its positive image for our society and significance to the well-being of humankind.

### **Acknowledgments**

The authors that represent the Belarusian State University gratefully acknowledge the BASF Representative Office in Belarus for the information and financial support of the activity devoted to the International Year of Chemistry.

### **Reference List**

1. [www.chemistry.bsu.by](http://www.chemistry.bsu.by)
2. Euroscope, 2010, 2, XIII
3. D. Grinshpan etc., Water: Chemistry and Ecology, 2011, 1, 52-60

# Development of learning materials assisted by animations and educational computer activities based on 7E model for “precipitation titration”

Nilgün SECKEN, Nazan KUNDUZ

Hacettepe University Education Faculty Ankara, TURKEY

E-mail: nazankunduz@gmail.com

## Abstract

The aim of this study is to develop a learning material that is assisted by animations and educational computer activities based on 7E model for the topic of “precipitation titration” included both in the analytical chemistry course at the undergraduate level and in the quantitative chemistry course at the secondary education level. The software of materials was developed based on the ADDIE model. The ADDIE model is consisted of the following five steps: analysis, design, development, implementation and evaluation. In addition to these specific steps, there are others to be followed in the process: identifying the needs, review of literature on animation, simulation, virtual labs and computer-assisted chemistry experiments, content analysis, developing experiment scenarios, developing the software, pilot study and taking views from the field specialists.

**Key Words:** Chemistry education, 7E learning model, animation, precipitation titrations, virtual lab, educational computer games

## 1. Introduction

The use of modern teaching technology has become more important to teach concepts. The computers in this regard are significant in that they lead to increased levels of learning addressing more than one senses. It in turn leads to long-lasting learning. Therefore, the use of animations, pictures and voice together makes possible to provide non-traditional learning environment and to increase the level of learning (Clark ve Craik, 1992). The research carried out by the Ministry of National Education indicated that mostly international softwares translated into Turkish are used in computer labs, indicating that there is no enough research and development study on software. Those software developed without scholarly reseach are reported not to meet the instructional standards (Dulger, 2004 in Kolomuç, 2009). Therefore, there should be studies uncovering necessary steps in the development of instructional softwares. Erdem (1998) concludes that although there are chemistry labs in all schools, chemistry teachers cannot do experiments. The reasons for this are stated as follows: lack of experiement materials, students’ not participation to the experiments and time constraints. Therefore, based on such concerns virtual labs or simulated experiments have become common as part of computer-assisted instruction. Virtual labs have a complicated internal structure and its use is relatively easy. Therefore, the aim of this study is to develop a learning material that is assisted by animations and educational computer activities based on 7E model for the topic of “precipitation titration” included both in the analytical chemistry course at the undergraduate level and in the quantative chemistry course at the secondary education level.

## 2. Method

### The development process of software for “precipitation titration”

The software of materials was developed based on the ADDIE model.



Figure 1. ADDIE Model (Koneru, 2010 in Tatlı and Ayas, 2011)

Design steps of ADDIE Model are given below:

### **Analysis:**

#### **1. Identifying the needs:**

Chemistry includes both concrete and abstract concepts. Therefore, students find it to learn hard. Abstract concepts should be delivered through active student participation. In the current study, a learning material that is assisted by animations and educational computer activities based on 7E model for the unit of “precipitation titration” included both in the analytical chemistry course at the undergraduate level and in the quantitative chemistry course at the secondary education level is developed. This unit is the last unit of both chemistry courses. Therefore, its significance seems not to be emphasized as much as it deserves. Specifically, the unit contains such significant chemistry concepts as solution, titration and precipitation.

#### **2. Analysis of target population:**

In order to meet the instructional and learning needs of students, their age, cultural background, prior experience, interests should be known and taken into consideration (Özen ve Karaman, 2001). Based on such information, the teaching methods or instructional materials proposed should be analysed in terms of their potential contribution to learning. The learning material has been developed taking into consideration their age, cultural background, prior experience and interests.

### **Design:**

#### **1. Identifying the goals:**

One of the major aims of chemistry is to make the students familiar with the scientific process. Learning materials used in the process of teaching should complement and support this aim and enable us to produce students who are curious, search for, classify, observe and make relations between prior information and newly acquired information. The learning materials developed in the study all serve for these purposes.

#### **2. Drafting the content:**

Drafting the content is one of the most important components of the design process. This is clearly about what to include in the content. The content of the learning materials developed is drafted based on topics and their relative order and prerequisites.

- ✓ In drafting phase, high school chemistry text books and related modules were analysed to determine the level of topics to be included.
- ✓ The concepts to be learned were identified.
- ✓ All definitions of the concepts identified in textbooks were reviewed and those appropriate for the level of learners were chosen and the order of the concepts in the teaching process was organized based on the relations among these concepts.

#### **3. Development and organization of the content**

The efficiency of the instructional materials depends upon the following factors (Feyziğolu, 2006);

- ✓ Teaching model used to identify the content of the course;
- ✓ Efficient use of the principles of visual design.

The software developed was designed based on the principles of the 7E learning model that is part of constructive approach to learning. These principles are given below:

**Excite:** At the first phase of the 7E learning model, Excite, learners ask the questions of “what do I know about the topic?, why did it happen? and what can I further learn about it ? and they begin to think about the subject. Teacher tries to increase the interest of the learners, asking questions to understand the prior knowledge of the learners about the subject at hand. The Fajans scenario was developed by the authors based on potential difficult points in the unit. At the end of the scenario, one question is asked via one character in it. Before answering this question, the students are informed about what they will learn at the

end of the section. After giving the content, an activity of DYK (Did you know that) is presented in the software. The answers of the students are discussed in the class to indicate the correct answer or answers. After the DYK activity, the other activity, “Remember what you know!” comes with aim of determining the prior knowledge of the students. Like in the previous activity, the answers of the students are discussed in the class.

**Explore:** The second phase of the 7E learning model is Explore. Students engaged in scientific research process through virtual lab in accordance with the premises of this phase of the 7E learning model. Specifically, the students were required to design an experiment to answer the question asked to them. The students carried out one experiment for the subsection of Fajans method: “determination of chlorine in the aquarium water”. While carrying out the experiment, the students followed the steps of scientific research. More specifically, they identified control, dependent and independent variables, and developed hypothesis. They discussed the hypothesis in the group to generate more accurate statements. Then, they were instructed to look at the page related to the materials and chemicals to be used in the experiment. In the related page, the students were given information about these materials and chemicals. After they chosen the materials and chemicals, they began to conduct the experiment. Whenever they had difficulty, they used help panels in the program. Additionally, they were asked to develop predictions about the experiment through the question of “What do you think about which point is the turning point in the titration process?”.

**Explain:** The next phase of the 7E learning model is Explain. At this stage, students try to draw graphics and make calculations to answer the focus question and prep questions. In a similar vein, the software asked the students to draw graphics based on their findings and to make calculations to solve the problem.

**Elaborate:** The next step of the model is Elaborate. At this stage, students are encouraged to generalize their newly acquired concepts and skills during the experiment to novice situations. On the same grounds, the students are asked to describe the design of another experiment in which other materials or chemicals were used and to discuss solution with their peers.

**Extend:** The phase of Extend includes the attempts to guide the students in making connections between their existing concepts and other concepts in other fields (Kanlı, 2007). In the study, for this aim the students were given several examples of precipitation titrations used in daily activities. They were also asked to discuss these examples with their peers.

**Exchange:** The step of Exchange involves the exchange of ideas between different groups of students. In the study, the students were given a topic to be discussed and asked to provide relevant examples from daily life situations and to defend their point of view using evidences and findings.

**Evaluate:** The last step of the 7E learning model is Evaluation. For this stage, an educational computer game, called “Who wants to get 100?” was developed. This game provided the students with the opportunity to repeat the learning included in the software. The game is in fact a quiz show, including twelve steps. In order to pass to the next level, the questions should be answered correctly. There were also three options given; half-half, phone and pass. Whenever the students were not sure about their answers, they might use these options.

### **Development:**

After the completion of content development, the content was given to the software team in the form of sheets. The software team was consisted of two undergraduate students. Additionally, a graphic designer and Maya programmer assisted the development of the virtual lab. Materials were developed using flash software program compatible with Windows Explorer.

### **Implementation:**

After the development of the software, the permission to use it was taken from the Ministry of National Education. Then the software was used.

### Evaluation:

Before the implementation, the software was reviewed by chemistry and BDÖ specialists. Based on this review, errors in writing, buttons and pages were all fixed and the software was finalized.

### User interface

As stated earlier, the software includes one subsection in the unit: the Fajans method. The toolbar of the software includes the following sections: “Notebook”, “Calculator”, “Periodic table”, “tools and glassware to be used in the experiments”, “chemicals to be used in the experiments”, “rules to follow in labs”, “symbols for safety”, “R-statements”, “S- statements”, “errors in quantative analysis”. Figure 2 presents the screen shoots of the software developed.

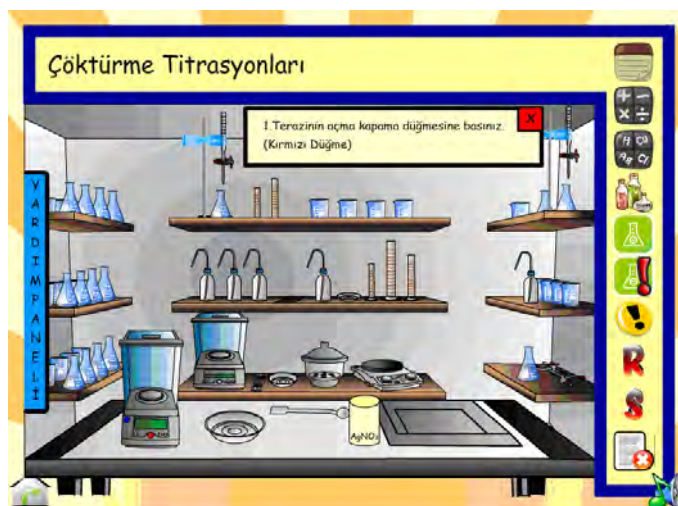


Figure 2. Screen shoots of the software

### 3. Results

In the study, a learning material, a software, that is assisted by animations and educational computer activities based on 7E model for the topic of “precipitation titration” included both in the analytical chemistry course at the undergraduate level and in the quantitative chemistry course at the secondary education level was developed. The software provides the learners with the opportunity to learn the topic of precipitation titrations through scenarios that includes daily activities. It also offers an interactional learning environment in which both macro and symbolic levels of experiments can be observed simultaneously. The learners can reach the experiments whenever they need or wish. It also enables them to repeat the experiments. It is found that the software reduces the workload of teachers, makes it possible to efficiently use the time and enables them to make use of the constructivist approach to teaching and learning. Therefore, it can be argued that virtual labs are alternatives to convenient labs and support them. It is further found that the educational game included in the software increased the student interest and motivation.

### References

- Clark, R. E. & Craik, T. G. Interactive multimedia learning environments. NATO ASI Series F: Computer and System Sciences, 93, Springer, Berlin, 1992.
- Dulger, İ. Case Study on Turkey Rapid Coverage for Compulsory Education Program. Conference on Scaling Up Poverty Reduction Shanghai, China May 25-27 2004.
- Grob, A. The Virtual Chemistry Lab For Reactions At Surfaces: Is It Possible? Will It Be Usefull, Surface Science, 500, 347-367, 2002.
- Jeschke, S., Richter, T. & Zorn, E. Virtual Labs in Mathematics and Natural Sciences, Online Educa Berlin. [http://www.ibi.tu-berlin.de/diskurs/veranst/online\\_educa/oeb\\_04/Zorn%20TU.pdf](http://www.ibi.tu-berlin.de/diskurs/veranst/online_educa/oeb_04/Zorn%20TU.pdf) Accessed 10 December 2010.
- Koneru, I. ADDIE: Designing Web-enabled Information Literacy Instructional Modules. DESIDOC Journal of Library & Information Technology, Vol 30, No3, May 2010, pp. 23- 34.
- Tatlı, Z. ve Ayas, A. Development Process Of Virtual Chemistry Laboratory. 5th International Computer & Instructional Technologies Symposium, 22-24 September 2011 Firat University, Elazığ-Turkey.

## Mathematical Models in Chemistry Lessons

Ines SCHMIDT, David-S. DI FUCCIA

*University of Kassel, Didactics of Chemistry, Heinrich-Plett-Str. 40D-34109 Kassel, Germany  
fon +49 561 804-4279 fax +49 561 804-4010  
ines.schmidt@uni-kassel.de*

### Abstract

*In chemistry it is often necessary to apply mathematical terms, methods and scientific paradigms in order to explain chemical phenomena. In the literature, it is assumed that a conscious handling of mathematical models in chemistry allows an explanation of the technical terms and can help to facilitate and deepen the understanding. That is why avoiding mathematical views in chemistry lessons might result in students having difficulties in developing an adequate understanding of chemistry. However, it is still unclear to what extent mathematical modelling is actually implemented in chemistry lessons at all.*

*Based on a detailed model of the process of mathematical modelling in chemistry, an analysis of the curricula of German upper secondary chemistry concerning the actual situation of mathematical content has been conducted. Furthermore, teacher interviews and analyses of different textbooks have been carried out in order to find out how the curricular guidelines are interpreted and how mathematical models are actually used in upper secondary chemistry. Results of these analyses will be given in the following article. Based on these findings, a study regarding problems with mathematical modelling in chemistry has been developed. Herein, tasks with incremental learning aids will be used as diagnostic tool in order to analyse pupils' problems within the process of mathematical modelling in detail.*

**Keywords:** Mathematical models in chemistry, modelling, modelling process, curricular guidelines, current teaching situation, incremental learning aids as diagnostic tool

### Framework

Using mathematical models like equations, functions, graphs, geometric figures or coordinates in chemistry means describing facts and data by using mathematical terms, methods or tools. Today, there are two ways of using mathematical models in chemistry lessons. On the one hand, mathematical models are used when calculating and applying, which means finding results by using given mathematical models. On the other hand mathematical models can be created by the learners and used in a process of explaining facts and data in order to solve a chemical problem or to answer a chemical question. This process constitutes the so-called mathematical modelling.

In the literature it is assumed that a conscious handling of mathematical models in chemistry allows an explanation of the technical term and can help to facilitate and deepen the understanding [1-2]. The support of the understanding is especially attributed to mathematical modelling. In chemistry lessons, mathematical modelling demands the transfer and usage of mathematical knowledge in new and significant situations and thus can support the comprehension of the technical terms that were modelled and foster problem solving skills [3]. Considering the acquisition of problem solving skills in chemistry, it seems reasonable to introduce tasks of mathematical modelling [4]. However, it is known that students have difficulties with connecting aspects of mathematics and chemistry [5]. But problems with mathematical modelling in chemistry lessons have not been examined, classified or even solved yet.

The following quotation points out the definition of mathematical modelling, which is used in didactics of mathematics: "We talk about modelling when pupils consciously justify or choose mathematical descriptions, a model and its assumptions, and when they validate the efficiency or the limit of the chosen model on the basis of the interpreted results." [6] This means mathematical modelling includes the whole process of mathematization as well as interpretation.

This process of mathematical modelling can be described by a model according to Blum and Leiß (2006), which helps explaining teaching-, learning-, and thinking-processes [7]. Adapting this model to the process of mathematical modelling in chemistry lessons, leads to the following model [8]

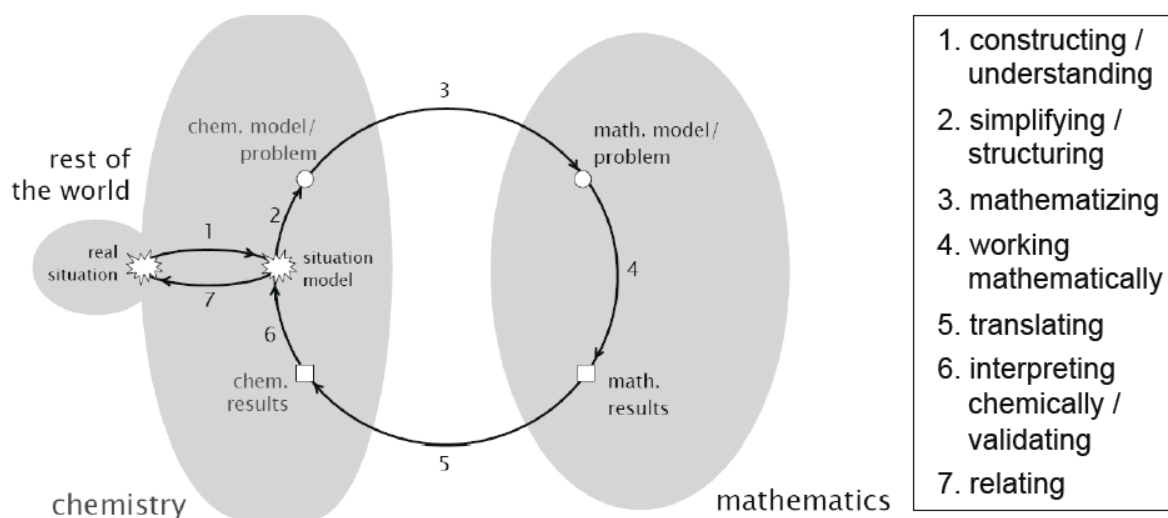


Fig. 1. The process of mathematical modelling in chemistry lessons [8]

Going through the process means starting with a situation in the real world. Pupils have to construct and to understand the problem or task and they have to simplify and to structure the problem in order to obtain a chemical model, such as reaction equations, laws, and resultants of chemistry. In the next step, pupils have to choose mathematical terms or methods in order to describe the problem mathematically and to obtain a mathematical model, e.g. a function or an equation. In step 4, being in the world of mathematics, pupils have to calculate to get mathematical results. Afterwards, they have to translate these results from a chemical point of view and they have to ask themselves whether these results are useful or not. Finally, they have to relate their results to the real situation.

The detailed description of the process of mathematical modelling allows a classification of students' difficulties with mathematical modelling. More precisely, it becomes possible to specify at which individual steps in the modelling process students face problems and which consequences this might have on understanding chemical phenomena. A precondition for that is to know, where and how mathematical models shall be used in chemistry lessons according to the curricula of the German federal states and where and how they are really used in everyday chemistry lessons. Up to now, however, there is rarely reliable information available from research in this area.

### Research questions

1. *In which contexts* should mathematical modelling be taught in chemistry lessons according to the curriculum?
2. *How* are mathematical models used in chemistry lessons? Is the use of mathematical models and mathematical modelling taught in chemistry at all?
3. Do issue-specific or general problems occur when pupils pass through *modelling processes*? For instance:
  - Are pupils able to transfer and apply competences acquired in maths class in chemistry settings?
  - Are pupils able to create chemical / mathematical models?
  - Do pupils use mathematical models?



## Methodology

1. In order to identify *in which contexts* mathematical modelling should be taught in chemistry lessons, the current German curricula of upper secondary chemistry have been analysed.
2. The following approaches are to provide a multidimensional insight into *how* such issues are taught in everyday chemistry lessons:
  - An inspection of different textbooks serves to get more details about the way the curricular guidelines are interpreted with respect to the mathematization of chemical concepts.
  - Teacher interviews were carried out in order to find out how mathematical models are actually used in chemistry lessons.
  - A qualitative analysis of the tasks of the centralised final exams for the subject chemistry will be done. It can be assumed that these tasks reflect which assignments or rather subject areas are currently deployed in chemistry lessons in secondary education.
3. In order to analyse the *process of mathematical modelling* in detail, tasks with incremental / stepwise learning aids [9] will be used as diagnostic tool in order to identify students' difficulties at each step of the process of mathematical modelling.

Up to now, tasks with incremental learning aids are known almost exclusively as learning tasks: Incremental learning aids allow students to deal with complex tasks or problems and they are predestined for tasks aiming at application and transfer of content. Moreover, these aids are suitable for problems showing a linear structure, typical for mathematical tasks in chemistry lessons. As these learning aids may be designed in respect of the single steps of the modelling process, tasks with incremental learning aids allow a clear distinction of the individual steps in the modelling process and can be designed as diagnostic tool to differentiate between chemical, mathematical as well as learning and procedural strategies. In this way, it can be determined whether the occurring problems during the modelling process are linked to a specific step of the process or to topic-specific difficulties. In particular, it can be examined whether and to what extent students are able to apply and transfer competences acquired in maths class in chemistry lessons, respectively. That is why such tasks seem to be suited for diagnosing the problems of pupils working on the modelling process, too.

First experiences with designing such tasks have shown that the aids have to be arranged in a different way than it is known from tasks with incremental learning aids as learning tasks. When designing tasks with incremental learning aids as learning tasks, the aids are structured in the following manner: In the first part of one aid a hint is given or a question is posed. In the second part of the aid the answer to this question is directly given. When designing these aids as diagnostic tool, we additionally differentiate between aids, which give a hint at the next step of the modelling process in general, and subsequent aids, which concretise the next step in the cycle and its realisation. In this way, each resulting aid covers a smaller part of reasoning within the modelling process, so that each single step in reasoning of the process is reproduced. Using tasks with incremental learning aids allows pupils to pass the whole process of mathematical modelling and researchers to diagnose pupils' problems in a more detailed way.

Within the study, tasks with incremental learning aids will be used to carry out a video study in which pupils have to work on a task of mathematical modelling in a laboratory situation.

Finally, additional loud thinking or interviews will help validating the results of using tasks with incremental learning aids.

## First results

By analysing the current curricula of upper secondary chemistry, topics were identified, which rely on a mathematization of chemical issues. The comparison of the curricular guidelines of the 16 federal states of Germany indicated that these guidelines differ enormously:

1. The curricula of the single federal states differ in respect of the topics, which require a mathematical analysis of chemical phenomena. For instance, half of all states request a quantitative analysis of an organic compound according to Liebig / Meyer, while the other half doesn't demand this topic.

2. The curricula of the single federal states differ in respect of the depth of mathematization, in particular:
- Mathematical views are more extensive in advanced courses than in basic courses in all federal states. For example, the Henderson-Hasselbalch equation has to be taught only in advanced courses but not in basic courses in almost every federal state of Germany.
  - The curricula differ in the recommendations of how mathematical modelling should be implemented in class. For example, one keyword that can be found in all curricula is “the law of mass action”. However, only in few curricula the derivation of that mathematical model is explicitly recommended. This means that dealing with the law of mass action is mandatory while the derivation is not.

A closer look at the identified points, where a mathematization of a chemical topic is possible, indicates that in 32.8% of all these points an explicit recommendation of how it should be taught is included. A closer look at these explicit recommendations reveals that in 82.8% (of these) a calculation or numeric example is demanded and only in 17.2% a derivation is mandatory.

Overall, two different types of using mathematics in chemistry lessons in the current German curricula of upper secondary chemistry can be identified:

1. Calculating and applying, which means finding results by using given mathematical terms, methods, tools and models (such as functions, graphs, geometric figures and coordinates)
4. Derivations of chemical laws and resultants, which can be described mathematically by using mathematical terms, methods, tools or models.

The keyword “mathematical modelling”, which comprises the whole process of explaining facts and data by using mathematics cannot be found explicitly in the current German curricula. This means that mathematical modelling as understood in the model above isn’t mandatory according to the curriculum, but it is feasible.

The analyses of different textbooks and the teacher interviews enable an insight into how the curricula are usually interpreted.

The analysis of the textbooks has shown that nearly every task with a mathematical share requires exclusively calculating and finding results by using given mathematical models (99.6%), but there are almost no tasks which demand a derivation or even mathematical modelling (0.4%). In 36.0% of these chapters, which aim at using mathematical models, a theoretical derivation is given by the textbook. In 36.5% of these chapters, which aim at using mathematical models, an example of how to use the mathematical model in a calculation is given directly by the textbook, so that pupils have to reproduce the calculation.

The teacher interviews (N = 13) have shown that derivations are nearly never implemented in basic courses. In advanced courses, derivations are almost exclusively presented by the teacher. In addition, the teacher always gives examples of calculations before pupils have to calculate on their own.

According to the teachers, derivations can help to foster the understanding, provided that pupils are good at mathematics. The fewer pupils from one class are good at mathematics according to the teachers’ estimation, the fewer mathematical models are used by teachers in chemistry lessons. In contrast, one of the biggest problems with mathematical models from the teachers’ point of view is that pupils very often lack elementary chemical knowledge, rather than mathematical basic knowledge.

On the whole, these analyses show that derivations or even mathematical modelling is currently not a priority, and especially tasks, which aim at such a conscious handling of mathematical models, are hardly used in chemistry lessons.

In order to find out, which assignments or rather subject areas are currently deployed in chemistry lessons in secondary education, the tasks of the centralised final exams are currently being analysed. The results of this analysis, as well as first experiences with using tasks with incremental learning aids will be published soon.

## References

- [1] K. Höner, Mathematisierungen im Chemieunterricht – ein Motivationshemmnis? In: *ZfdN*, 1996, 2 (2), pp. 51 -70
- [2] F. Harisch, Mehr rechnen im Chemieunterricht! In: *NiU Physik / Chemie* 1979, 27 (2), pp. 57-60
- [3] P. Borneleit, R. Danckwerts, H.-W. Henn, H.-G. Weigand, Expertise zum Mathematikunterricht in der gymnasialen Oberstufe. In: H.-E. Tenorth (Hrsg.): *Kerncurriculum Oberstufe*. – Weinheim: Beltz, 2001, pp. 26 – 53
- [4] U. Beck, S. Markic, I. Eilks, Modellierungsaufgaben im Chemieunterricht. In: *PdN Chemie in der Schule* 2010, 59 (6), pp. 5 – 7
- [5] M. Potgieter, A. Harding, J. Engelbrecht, Transfer of algebraic and graphical thinking between Mathematics and Chemistry, *Journal of Research in Science Teaching*, 2008, 45 (2), pp. 197-218.
- [6] A. Büchter, T. Leuders, Mathematikaufgaben selbst entwickeln. Lernen fördern – Leistung überprüfen, Berlin: Cornelsen Scriptor 2005
- [7] R. Borromeo Ferri, Modelling problems from a cognitive perspective. In C. Haines, P., et al. (eds) *Mathematical Modelling - Education, Engineering and Economics*, Chichester: Horwood Publishing, 2007, pp. 260-270.
- [8] I. Schmidt, D.-S. Di Fuccia, Mathematical Modelling in Chemistry Lessons, in Paul van Kampen, Brien Nolan, Odilla Finlayson, ed.(s), Eilish McLoughlin, chair *ESTABLISH | SMEC 2012 Teaching at the heart of Learning*, Dublin City University, Ireland, 7-9th June 2012, pp. 16-20.
- [9] F. Schmidt-Weigand, M. Hänze, *Incremental support in learning with worked examples: A quasi-experimental field study*. Paper presented at the 13<sup>th</sup> bi-annual meeting of the European Association of Research on Learning and Instruction, Amsterdam, the Netherlands, 2009

## New methods to teach chemistry to children with special needs in student labs

**Barbara SCHMITT-SODY, Andreas KOMETZ**

*University Erlangen-Nuremberg, Regensburger Str. 160, 90478 Nuremberg Germany,*

*E-mail: baschmit@ewf.uni-erlangen.de*

*Phone: +49/ 911/5302576*

### **Abstract**

*In Germany extra-curricular student labs increase student interest in a subject area by providing independent and hands-on experiments and are an important innovation in education. The student lab at the University Erlangen-Nuremberg is called NESSI-Lab and focuses on chemistry. NESSI-Lab offers school classes from first to sixth grade a one day experience in chemistry, with age-appropriate experiments about fire, water, air, and earth. The feedback received from participating students and teachers was very good and resulted in an extension to another target group: children with hearing loss and learning disabilities. The frequently modified cognitive, linguistic, motor, and social development of hearing-impaired children and children with learning disabilities requires existing experiments to be adjusted, as well as their instructions and NESSI-Lab schedule. A pilot study was conducted to adopt changes to the Lab to accommodate the restraints mentioned above. The understanding and learning gains have been examined by interviews with 25 hearing-impaired children aged between 8 and 10 years. The results of a survey of special education teachers about experiments in special education schools, the adapted NESSI-Lab concept, and first results of an interview study about understanding and learning gains of children with hearing loss shall be presented.*

**Key Words:** student lab – special needs – experiments – hearing loss – learning disabilities

### **1. Introduction**

By providing independent and hands-on experiments, student labs in Germany are an important innovation in education, increasing student interest in a subject area. The student lab at the University of Erlangen-Nuremberg offers school classes from first to sixth grade a one day experience in chemistry, with age-appropriate experiments about fire, water, air, and earth. The NESSI-Lab is designed to support scientific literacy and the development of an interest in chemistry. In NESSI-Lab student teachers support and look after the participating children. Because of the positive experience, the project was extended both for older children and for children with special needs, especially those with hearing loss and learning disabilities. The effects of the disabilities are taken into consideration in the new “NESSI-FÖSL” concept.

### **2. The consequences of learning disabilities and hearing loss**

Children with a learning disability often have a modified cognitive and social development, attention problems, central auditory processing disorders, and visual and motor problems. The behavior problems are often caused by attention deficit hyperactivity disorder or by the family environment. If they have a migration background they also very often have language problems [1].

Children with hearing loss also have language problems. Even with hearing aids or a cochlea implant, they have reduced language acquisition, a reduced lexicon, lower speaking skills, and a lower reading and writing level compared to hearing children of the same age. They have often a lack of knowledge, especially concerning things which are learned in daily life by missing language and sounds [2, 3].

### **3. The research design of “NESSI-FÖSL”**

Since there is little information in the literature about experimenting with children with special needs, we

developed the following research question for the project: “How should a student lab for children with special needs be designed to achieve a high rate of understanding and learning?” Afterwards, teachers were consulted about experiments in lessons with disabled children. Then NESSI-FÖSL was conceived, tested, and evaluated to refine the NESSI-Transfer concept. The results of each step are presented below.

#### 4. Expert study

To determine the changes necessarily to the lab and accommodate the children’s learning difficulties mentioned above, an expert study was conducted. 68 special education teachers filled out a survey to analyze specifics in experimenting with children with special needs. With a combination of qualitative content analysis [4] and Grounded Theory [5] the open questions of the questionnaire were analyzed.

The teachers use easy linguistic simplification, pictures, and visualizations in the instructions for the experiments. The instructions have to be highly structured and clearly arranged. To explain the experiments the teachers use models, simplified language, visualizations, and short instructions. When choosing an experiment, the teachers think about the safety, the necessary language, the materials, etc.

Afterwards the instructions for NESSI-Lab experiments in regular school were reviewed by five special needs teachers. They asked for simpler language, shorter sentences, more structure, improved clarity, and pictures or diagrams to support the understanding of the language. They suggested using clozes, drawings, and models to explain the experiments.

#### 5. The NESSI-Transfer concept

The results of the expert study required a modification of the “NESSI-Lab” concept to enable the special needs students to conduct experiments independently and to experience and understand chemical phenomena and their context.

Figure 1 shows certain aspects of the Lab which were changed: the required time, selection of experiments, and their instructions. Also there are special introduction for the students looking after and supporting the children in the lab and other special measures needed.

Because of the low concentration skills of the children, the length of the lab was shortened for the younger children, breaks were extended and the experimental time was reduced. The children had to write down the results of the experiments to improve their visualization and to help them remember the results better. Due to the children’s low reading and writing skills, the worksheets are written in easy language and have clozes and drawings, which must be completed.

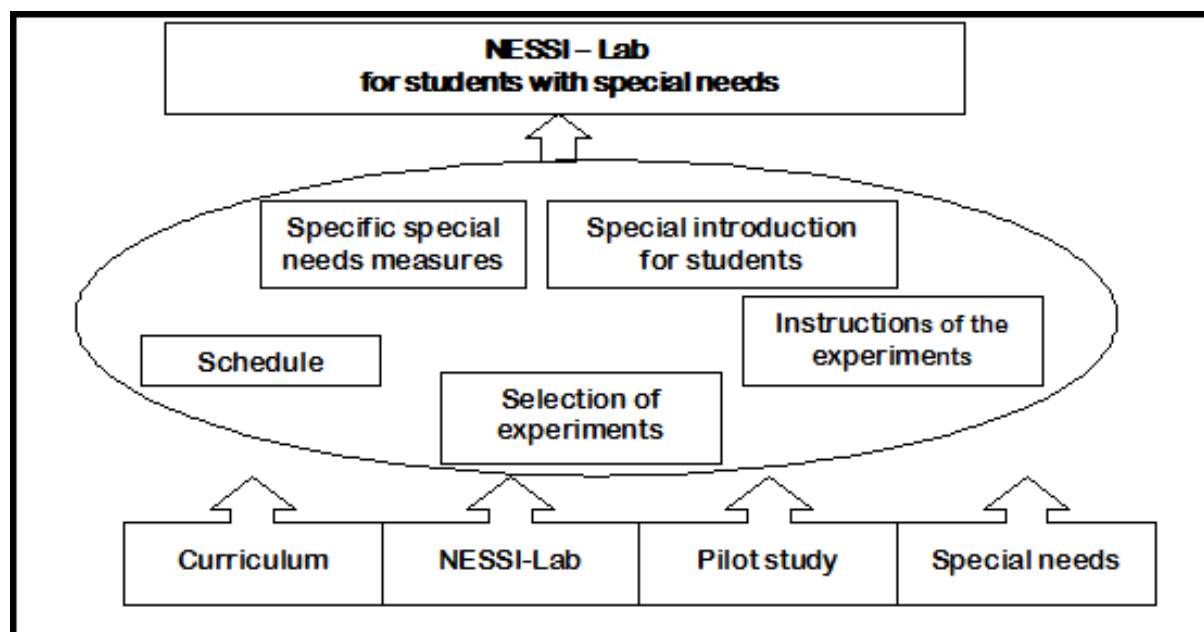


Figure 1 The Transfer [6]

Also the instructions of the experiments have a lot of visualizations, pictures and, require low language skills. They are easy to understand and support independent learning.

The experiment selection of the regular NESSI-Lab was also modified. Some experiments have to be replaced or changed, because of their complexity or high language skills. For a better understanding, models, word cards, etc. were developed.

In the Lab, the children are supported by university students. They are studying to be teachers in regular schools, and therefore they are inexperienced in dealing with disabled children and need a short introduction in “special education”. For example they need to practice how to speak with children with hearing aids or how to help those with learning disabilities.

While testing this concept, the student teachers and the leader of the lab discussed problems with the materials and the experiments and how they could be improved. An interview study was started for a better understanding about the problems the children had.

## 6. Evaluation of the student lab

The evaluation consisted of interviewing children with hearing loss who visited the student lab. The half-structured interviews about the understanding and learning gains were taken before their visit, one day after, and three months after experimenting in the student lab. The interviews were analyzed with a combination of qualitative content analysis [4] and Grounded Theory [5]. The children who were using Sound Accompanying Sounds had linguistic problems in remembering and describing the experiments. They mixed up the words and signs or even couldn't sign the technical terms.

Some experiments have to be reworked or removed from the concept. Some need additional visualizations or models for better understanding. The children remembered the experiments much better than the explanations of the results. They really liked the visit to the student lab because of the experiments and variety to the school [7].

## 7. Conclusion

The linguistic problems illustrated above necessitated measures for improving the language skills. Because of the good experience in using a glossary for supporting these competences, a glossary was developed. The glossary explains the words with short sentences, pictures, and hand signs. The word cards should be used in the lab for better understanding and learning new technical terms. In the dictionaries of the German Sign language very few chemical technical terms are illustrated. In cooperation with a deaf chemist the glossary and the hand signs, for example for “beaker”, were developed.

Additionally other materials and models were created. Some experiments had to be split into multiple experiments to help the children understand them better.

Because of the improving inclusion in Germany, the specific concept “NESSI-FÖSL” is integrated in the regular one. The materials are used for internal differentiation for children with disabilities. Additional teachers at regular schools are thankful for the special experiments and materials for the differentiation in their lessons.

## Literature

- [1] H. Suhrweier, Lernbehinderte Kinder und Jugendliche – Kennzeichnung der Population. In: G. Siepman (eds.) Lernbehinderung, pp. 289-320. Ullstein Mosby, Berlin 1993.
- [2] S. Easterbrooks, S. Baker, Language Learning in children who are deaf and hard of hearing, Allyn & Bacon, Boston 2002.
- [3] A. Leonhardt, Einführung in die hörgeschädigten Pädagogik, Reinhardt-Verlag, Munich, Basel 2002.
- [4] P. Mayring, Qualitative Inhaltsanalyse. Grundlagen und Techniken, Beltz, Weinheim 2003
- [5] B. Glaser, A. Strauss, Grounded Theory. Strategien qualitativer Forschung, Hans Huber, Bern 1998.
- [6] B. Schmitt-Sody, A. Kometz, Experimentieren mit Förderschulkindern. In: Sascha Bernholt (eds.) Konzepte fachdidaktischer Strukturierung für den Unterricht. Gesellschaft für Didaktik der Chemie und Physik Jahrestagung in Oldenburg 2012, page 131-133. Lit Verlag, Berlin 2012.
- [7] B. Schmitt-Sody, A. Kometz, NESSI-Transfer: Experimentieren mit hörgeschädigten Kindern im Schülerlabor, pp. 78-82 Hörpäd, 2, 2012.

## Reflecting authentic learning environments in pre-service chemistry teacher education and translating it into practice

Andrea SCHUMACHER, Christiane S. REINERS

*Institute of Chemistry Education, University of Cologne  
Herbert-Lewin-Str. 2, D-50931 Cologne  
Email: andrea.schumacher@uni-koeln.de Phone: 0049-221-4704990*

### Abstract

*The following paper describes a qualitative study which is currently conducted at the Institute of Chemistry Education of the University of Cologne. The aim is to provoke pre-service chemistry teachers to reflect about their pre-conceptions of authentic chemistry practice and to support the students in developing authentic learning environments. The paper focuses on one part of the study in which teacher students were asked to create an out-of-school lab-day for a high-school class. They had to embed criteria of authentic chemistry practice which were developed through a stage stimulating reflection and discussion. Questionnaires, portfolios and interviews were used to collect data and which were analyzed by qualitative content analysis. The results show that reflection of students' pre-conceptions can be initiated successfully. The transformation into a practical activity for pupils succeeds in parts, but the prospective teachers need more support. This problem is going to be addressed in further parts of the study.*

### Keywords

Authentic chemistry practice, pre-service teacher education, authentic learning environments, practical transformation

### 1. Introduction

Authenticity seems to be a catchword in the area of science education – without a common understanding of this term. Authentic chemistry as it is used in this project can be described by the principle of “making science learning better resemble science practice” [1]. The constituents of authentic chemistry practice are described by research regarding Nature of Science [2], Philosophy of Chemistry [3] as well as Inquiry-based Learning [4]. When engaged in authentic learning environments in chemistry lessons, the students should not only do but also reflect about chemistry. This corresponds with and can be one way to promote scientific literacy, which is a main goal of science education [5]. Scientific literacy was one of the guiding themes for developing the new educational standards focusing on competences in Germany [6-7] after the first PISA results had been published.

The question arises whether and to what extent pre-service teachers are able to create learning environments which meet the demands of the new curricula, i.e. are they prepared correspondingly during their education? It has to be considered that teachers' conceptions constitute a necessary but not a sufficient condition for translating these conceptions into school practice [8]. Students develop certain conceptions of the subject they are studying, for example based on the way the discipline is portrayed in the media or in school text books. Research has illustrated that students often have naïve or not very concrete images of science [9]. That is why the main goals of this project are to initiate reflection about pre-conceptions of authentic chemistry practice which the teacher students have already developed before and during their studies and to enable these students to create authentic learning environments for chemistry lessons.

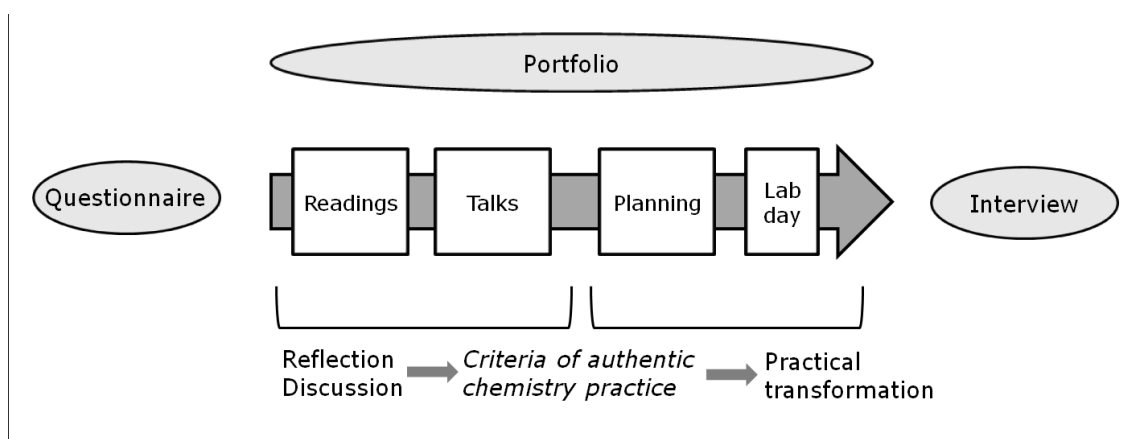
### 2. Methodology

The long-term aim of the project is to develop a module for chemistry teacher education at university level which addresses the two goals mentioned above. Therefore different courses were planned, conducted and evaluated in order to detect possible elements on which the new module can be based. This

paper focuses on one of these courses, a chemistry education course called “Chemistry meets Chemistry Education” (CmCE) for chemistry teacher students in their advanced studies. The CmCE course was conducted and tested during the summer semester 2010 and then repeated in the following winter semester. During this part of the study two main research questions were pursued:

- How do students’ pre-conceptions of chemistry practice develop during a class focusing on authentic chemistry?
- What kind of ideas and problems do teacher students have when creating authentic learning environments?

Figure 1 shows the different elements which were applied in the winter semester CmCE course as well as the research tools that were used. On the whole 19 teacher students took part in the course of which 13 participated for the study.



**Figure 1** Time-line of the course (arrow) with course elements (rectangles) and research tools (ovals)

The first part of the semester consisted of various readings presenting different aspects of chemistry and chemistry education. Another central element was three talks of chemists for the students, in which the chemists presented latest results in their field of expertise and gave an impression about their life as a scientist. This first part was to stimulate the students to reflect about their pre-conceptions. The discussion with other participants should help the pre-service teachers to critically contrast their own views against those of others. As a result of this the students formulated criteria of authentic chemistry practice. In the second part of the course the students planned and conducted an out-of-school lab-day called ‘A Chemical Winter-Day’ for a high-school class which came to work in the institute’s laboratories for one day and were guided by the students. With this lab-day the prospective teachers should convert the developed criteria into a practical lesson.

Different research tools were used for the study. Before the course the students had to fill out an open ended questionnaire about characteristics of authentic chemistry practice. During the semester a portfolio had to be written as a means to reflect the course and find out possible changes in attitude and conceptions. Two months after the end of the course semi-structured interviews with each student were conducted in order to validate statements the prospective teachers made in their portfolios and to solve unclear issues. All of the questionnaires, portfolios as well as interviews were analyzed by one type of the qualitative content analysis, the inductive category development according to Mayring [10], in which a category system is created out of the obtained material and is guided by theory and the research questions. As a result individual profiles are developed for every student and compared among each other.

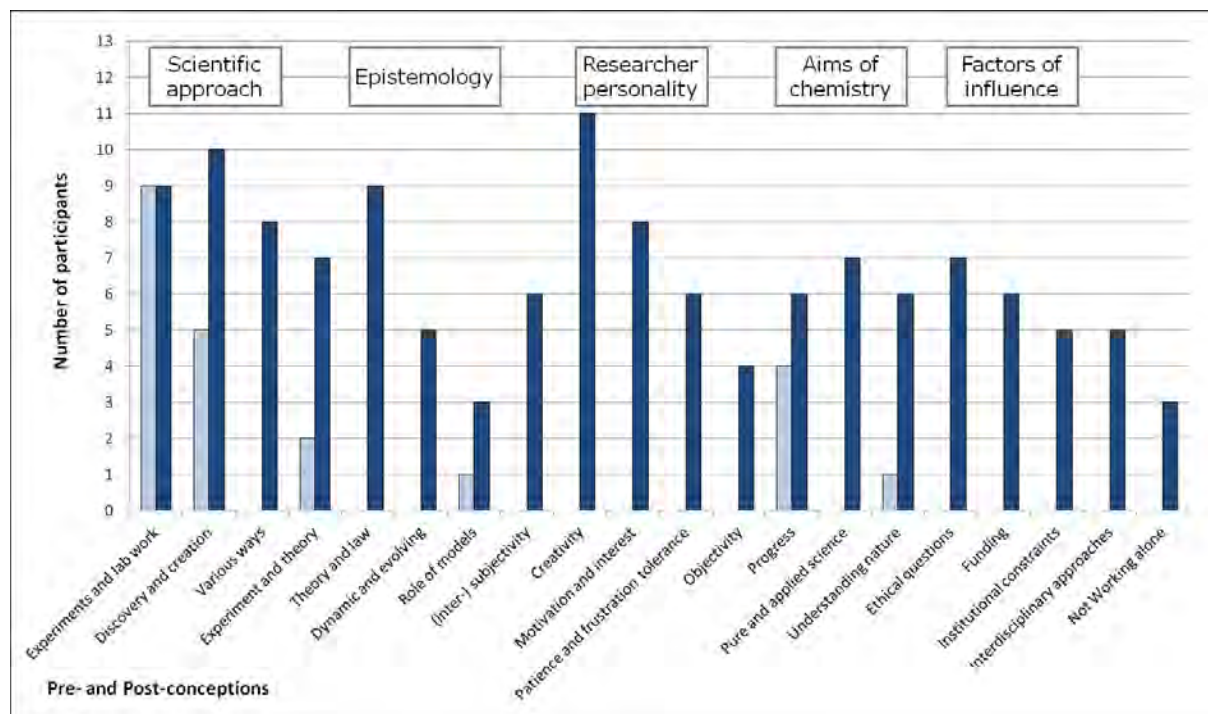
### 3. Findings

#### 3.1 How do students’ pre-conceptions of chemistry practice develop during a class focusing on authentic chemistry?

The qualitative content analysis and the comparison of the students’ profiles show that the most common



pre-conceptions given by the prospective teachers are that chemistry is about conducting *experiments*, making *discoveries* as well as achieving *progress* (Figure 2, light columns). The post-conceptions (dark columns) stated by the students can be arranged into five categories: scientific approach, epistemology, researcher personality, aims of chemistry and factors of influence. In the following some examples from the students' portfolios or interviews are cited.



**Figure 2** Overview of the most common pre- and post-conceptions arranged into categories. On the x-axis the post-conceptions are represented by the dark columns, the pre-conceptions by the light-colored columns. The y-axis represents the number of participants stating the respective conception

The initial view that *discoveries* are a part of the scientific approach was widened to a more detailed conception. The students realized “that chemistry is determined by two important components, discovery and creation” (Portfolio RA)<sup>1</sup> and became aware that synthesis is a distinctive feature of chemistry at the end of the course. Especially by listening to the talks of the three chemists the prospective teachers wrote more about the 'human' aspects of research. For example one student realized that “research has a lot to do with the beliefs, attitudes and character of the researcher” (Portfolio NA). Factors influencing research, e.g. ethical questions, institutional constraints or funding were mostly unknown to the participants before the CmCE course. As one person stated: “Chemistry research also depends on financial means [...]. A starting point for research can also be a PhD thesis which depends on the topic of the group and institutional conditions” and “there are aspects which I had not connected with chemistry research before [...] for example ethical awareness” (Portfolio KA).

### 3.2 What kind of ideas and problems do teacher students have when creating authentic learning environments?

The teacher students tried to implement some aspects which they connected with authentic chemistry (and scientific) practice into the out-of-school lab-day – for example problem-solving, self-reflection, hypothesis testing and environmental risk evaluation. The last two aspects were used in one learning station which was supposed to make the pupils find the best de-icer that is also less harmful to the environment. Another group wanted the pupils to work with heating pads. In regard to the planning of this learning station one student said that “at first we only wanted to stubbornly build a heating pad. Then we

<sup>1</sup>Portfolio RA describes the data source and student (identified by the two letter code) who gave the particular statement (translation by the author).

realized that this does not contain any problem-solving aspects” (Interview RE). Another member of the group stated that “simply building a heating pad would have been this magic trick again, and it is more important to show that it is not a magic trick but rather how it works” (Interview EN). These two quotations show that the prospective teachers also experienced some difficulties during the planning of the lab-day. In this and other groups the students were unsure how to transform the criteria of authentic chemistry practice into an activity for pupils. Other problems concerned finding or developing appropriate experiments and a lack of experience – either with planning of lessons or inquiry-based learning. The last point can be illustrated by one students who wrote that “presumably I answered the questions like someone who does not study chemistry, probably because I have come into contact with chemistry during my studies, but not with the approach of a researcher” (Portfolio ET).

#### 4. Discussion and outlook

The initiation of reflection, which was the first opportunity to do so for most of the students, was successful. All of the participants changed their prior held views in the sense of broadening, concreting or correcting them, revealed by more elaborated and more wide-ranging post-conceptions<sup>2</sup> found in the students’ portfolios and interviews (Figure 2). The students stated characteristics of science in general as well as chemistry specific aspects. The emerging categories of post-conceptions correspond with classifications found in literature [2, 11, 12].

The students were successful in developing an out-of-school lab-day, i.e. with the practical transformation of criteria of authentic chemistry practice, but they also perceived some difficulties. Some of these problems might be related to a lack of experience with inquiry-based learning, i.e. the teacher students have not experienced this kind of learning approach in their studies before.

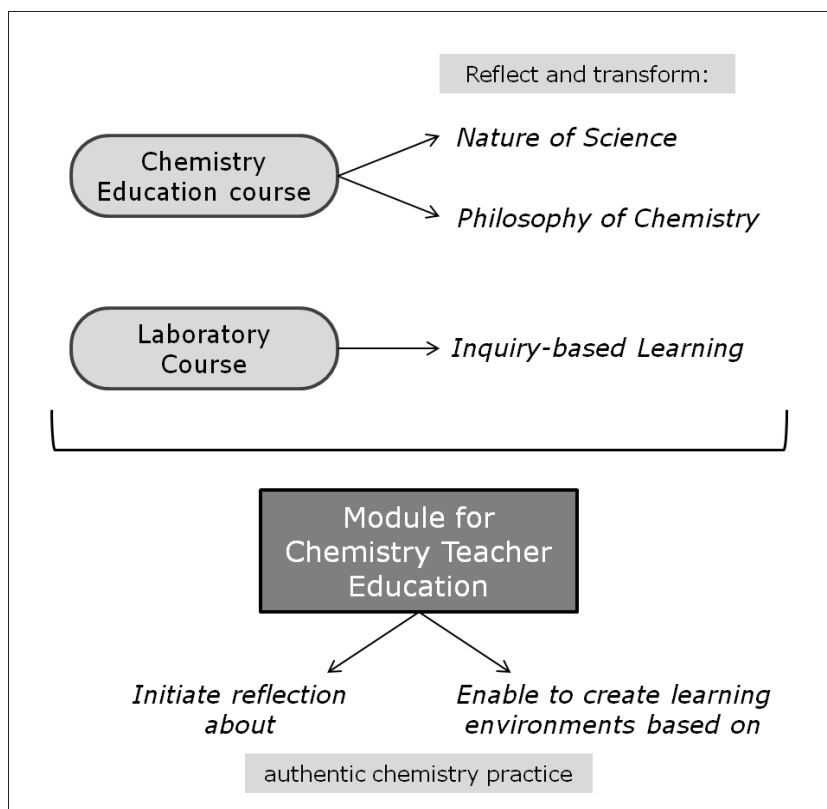


Figure 3 Overview project

<sup>2</sup>Pre-conceptions of laws and theories seem to be resistant to change by intervention [13], which was partly confirmed in this study. This problem was addressed in another study conducted by Christiane Reiners (Learning to Teach the Nature of Science – The Impact of an Explicit Approach), which can also be found in the proceedings paper.

That is why the following part of the project is going to focus on laboratory courses into which aspects of inquiry-based learning are going to be embedded. Combined with the results gained from the CmCE course this will serve as a basis for developing the new module for teacher education (see Figure 3).

## Reference list

- [1] D. C. Edelson: Realising Authentic Science Learning through the Adaptation of Scientific Practice. In B. J. Fraser, K. G. Tobin (eds.) *International Handbook of Science Education Vol.1*, pp. 317–332. Kluwer, Dordrecht, (1998)
- [2] W. F. McComas (ed.), *The Nature of Science in Science Education: Rationales and Strategies*, Kluwer, Dordrecht 1998.
- [3] J. Schummer: Philosophy of Chemistry. In: F. Allhoff (ed.) *Philosophies of the Sciences: A Guide*, pp. 163–183. Wiley-Blackwell, Malden, (2010)
- [4] D. D. Minner, A. J. Levy and J. Century, *J. Res. Sci. Teach.*, 2010, 47(4), 474
- [5] OECD, *The PISA 2003 Assessment Framework: Mathematics, Reading, Science and Problem Solving Knowledge and Skills*, OECD, Paris 2004.
- [6] Kultusministerkonferenz, *Bildungsstandards im Fach Chemie für den Mittleren Schulabschluss (Jahrgangsstufe 10): Beschluss vom 16.12.2004*, Luchterhand, Neuwied 2005.
- [7] H. Schecker, I. Parchmann: Standards and competence models: The German situation. In: D. J. Waddington (ed.) *Standards in science education: Making it comparable*, pp. 147–164. Waxmann, Münster, (2007)
- [8] N. G. Lederman, *J. Res. Sci. Teach.*, 1992, 29(4), 331
- [9] R. Driver, J. Leach, R. Millar, P. Scott, *Young people's images of science*, Open University Press, Buckingham 1996.
- [10] P. Mayring: Qualitative content analysis – research instrument or mode of interpretation? In: M. Kiegelmann (ed.) *The role of the researcher in qualitative psychology*, pp. 139-148. Huber-Verlag, Tübingen, (2002).
- [11] C. J. Wenning, *J. Phys. Teach. Educ. On.*, 2006, 3(3), 3
- [12] B. Martin, H. Kass, and W. Brouwer, *Sc. Ed.*, 1990, 74(5), 541
- [13] J. Bruns, *Auf dem Weg zur Förderung naturwissenschaftsspezifischer Vorstellungen von zukünftigen Chemie-Lehrenden: Chancen und Grenzen eines kombinierten theoretisch-expliziten und praktisch-reflektierten Ansatzes*, Logos, Berlin 2009. See also: Ch. S. Reiners: Reflection on Nature of Science (NOS) Aspects of Teaching Scientific Inquiry. In: L. Menabue, G. Santoro (eds.) *New Trends in Science and Technology Education*, pp. 207-214, Clueb, Bologna, (2010)

## A Learning Progression Approach to Studying Benefits, Costs and Risks in Chemical Design

Steven CULLIPHER<sup>1</sup>, Hannah SEVIAN<sup>1,3</sup>, Vicente TALANQUER<sup>2</sup>

<sup>1</sup>University of Massachusetts Boston, Department of Chemistry, 100 Morrissey Blvd., Boston, MA 02125

<sup>2</sup>University of Arizona, Department of Chemistry and Biochemistry, 1306 East University Blvd., Tuscon, AZ 85721

<sup>3</sup>To whom correspondence should be addressed: Hannah.Sevian@umb.edu, (o) 001.617.287.7724, (f) 001.617.287.6030

### Abstract

*One of the most important thinking processes relied upon by chemists is weighing the benefits, costs and risks (BCR) in chemical product design. Preparing students to be chemists who are equipped to work in modern chemistry requires educating students to reason strategically about BCR. The development of learning progressions in this area could help to support such educational efforts. A learning progression is a description of potential pathways along which students advance, over an extended period of time, in understanding and ability to apply core ideas. Such a progression can be characterized by identifying changes in the implicit assumptions that students make about BCR in the context of chemical design. To illustrate this idea, initial results are presented for the characterization of a hypothetical learning progression for BCR in chemical design. The characterization results from analysis of existing research, and an experiment using research in chlorofluorocarbon (CFC) replacement compounds as a contextual issue for exploring student reasoning. In the experiment, interviews are being conducted with undergraduate chemistry students at different levels in their training to uncover BCR reasoning while analyzing a realistic scenario. The scenario presents an opportunity for students to generate instantaneous mental models, which are then probed by survey and interview questions designed to uncover the students' underlying implicit assumptions that constrain the models. These data permit the construction of a hypothetical learning progression that describes likely pathways in the evolution of increasingly sophisticated implicit assumptions that constrain BCR reasoning in the context of chemical design.*

**Keywords:** learning progression, risk analysis, green chemistry, decision theory, risk perception, implicit assumptions

### 1. Subject/Problem

The analysis, synthesis, and transformation of chemical substances have many benefits for modern societies. However, there are also social, political, economic, and environmental costs and risks that need to be taken into account when making decisions involving the application of chemical design.

We contend that student understanding develops along a framework, which varies among individuals, from neophyte to sophisticate over an extended period of time. This framework can be mapped in a theoretical multi-dimensional space such that each of the various coordinate axes, while not necessarily orthogonal, represents a progress variable along which individuals move as their understanding changes. We refer to this framework as a learning progression (LP). In the past few years there has been a surge of interest in the development of LPs of central ideas in the sciences that can serve as curriculum models and assessment frameworks in educational settings. LPs describe successively more sophisticated ways of thinking about a topic [1-2] and are based on educational research about how people learn, existing pedagogical content knowledge in the area of interest, as well as on the critical analysis of the structure of the associated disciplinary knowledge. To date, educational researchers have developed LPs in science for diverse topics such as atomic-molecular structure [3-4], properties of matter [5], carbon cycling [6], force and motion [7], genetics [8], the theory of evolution [9], and scientific argumentation [10]. However, there

is still ample debate on issues such as what constitutes progress in a given area, how more sophisticated ways of thinking are characterized, and whether progress can be described as a series of successive levels of understanding [11].

The LP research in the present study considers progress of learning to be characterized in terms of implicit assumptions that people make about the properties and behaviors of the members of a given category [12]. These implicit assumptions act as cognitive constraints that guide and support, but also constrict a person's reasoning. Cognitive constraints help people make decisions about what behaviors are possible or not and about what variables are most relevant in determining behavior. Cognitive constraints may change over time with development and learning; some of these constraints may lose or gain strength depending on existing knowledge, contextual features, and perceived salient cues and goals of a task. Thus, from this perspective, defining progress in understanding may be facilitated by first mapping the landscape of cognitive constraints that most commonly guide student reasoning when engaged in learning about a specific topic.

This study is concerned with uncovering the cognitive constraints that exist among undergraduate students at various levels of training in chemistry, as well as the progress variables along which the implicit assumptions of individuals develop with training in chemistry. Ultimately, the intent of the research is to uncover educationally productive “stepping stone” intermediate understandings, characterized by combinations of particular implicit assumptions, through which learning can be deliberately directed by strategic use of instructional and learning resources. In this regard, this knowledge is crucial for the development of curriculum, instruction and assessments in chemistry. Specifically, toward developing a hypothetical LP to describe BCR reasoning, the study described in this paper was designed to answer the following research questions:

- (a) How do students reason about benefits, costs and risks in chemical design?
- (b) How does the reasoning of chemistry experts differ from that of chemistry novices?
- (c) What evolution of implicit assumptions can account for the relative degrees of sophistication of reasoning from novice to expert?

## 2. Design

### 2.1 Overall Study Design

Research on risk analysis and perception is extensive. However, in the context of scientific decision-making, and specifically about chemistry, the scope of research is limited. Following the framework for a learning progression as described above, a study was designed to uncover how benefit, cost, and risk analysis progresses in the advancement of chemical education. This study was designed to have three phases:

- *Phase 1:* Development of initial descriptions, by reviewing existing literature, of core implicit assumptions that are likely to guide student reasoning about benefits, costs and risks in chemical design.
- *Phase 2:* Refine and enrich, via surveys and individual interviews, initial hypotheses about the evolution of core implicit assumptions.
- *Phase 3:* Generate hypotheses about critical steps in the progression from novice to sophisticated reasoning of benefits, costs and risks in chemical design.

The study is currently in Phase 2. A review of existing literature was conducted and an initial experiment was designed to uncover further information where the literature is sparse. This paper reports on the experiment and also provides references to the limited amount of related literature.

### 2.2 Initial Descriptions of Core Implicit Assumptions

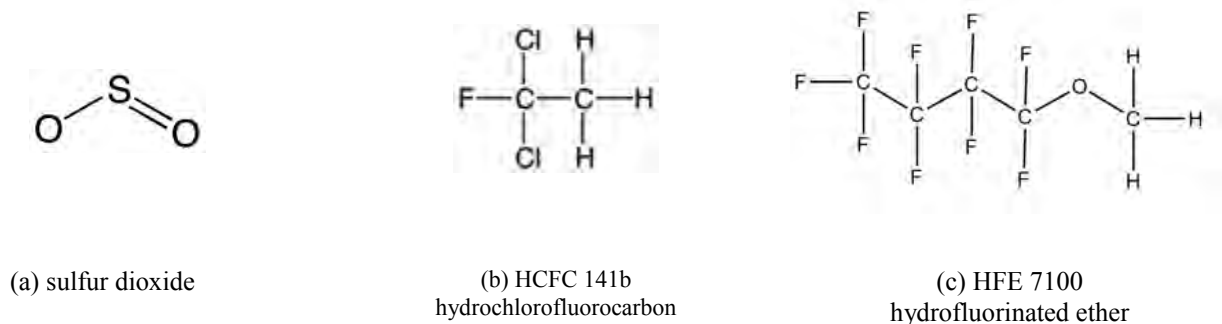
There is no research directly related to students' understandings of BCR in chemistry. However, three well-developed areas of research that are not directly related to BCR are relevant:

1) risk perception research in psychology, 2) risk assessment research in economics and environmental science, and 3) decision theories in philosophy and economics. Attention was focused on examining studies in which ideas held by wide populations were examined, and, where possible, studies of ideas that seem to persist among students or study subjects despite educational interventions.

### 2.3 Case Study Instrument to Enrich Initial Hypotheses

In order to enrich initial hypotheses about progress variables along which students' implicit assumptions progress, a case study was developed centering on the topic of CFC replacement compounds. The case study presents three possible compounds (Figure 1) that have been or could be used as refrigerants. Historically there have been many compounds used as refrigerants. All refrigerants eventually become atmospheric and environmental contaminants. Thus, a question of their use becomes "What happens to this refrigerant when it gets released from the intended system?" Study participants were asked to select from amongst a historical refrigerant ( $\text{SO}_2$ ), a refrigerant currently being used with known risks and benefits (HCFC) and a refrigerant currently under study in atmospheric chemistry research (HFE) that has possible unknown risks but with benefits that are considered to be well understood. While the history of refrigerants and similar chemicals includes many more than these three options, each of these compounds displays unique and complementary benefits and risks which make possible a logically distinct set of options from which a person may select a best choice. Among the choices provided, the case study outlined three types of considerations: monetary cost, environmental impact, and human health. For each consideration, the case study laid out a clear best and worst option (i.e. for monetary cost, there was a least expensive and a most expensive option). Decision theory [13], described in the next section, provided a means of determining what information had to be disclosed in the case study in order for there to be sufficient information to make a decision without over-specifying the problem.

Participants were asked to select the best choice of compound for use by an air conditioner manufacturing company. For each compound, in-text arguments for the pros and cons of each compound were provided. Following the survey, individual interviews were used to elicit justifications and probe the decision-making process behind participants' thinking.



**Figure 1.** Refrigeration compounds presented to participants in the case study.

This preliminary study included interviews with individuals considered to be experts (faculty and upper level graduate students,  $N=5$ ) and novices (first semester general chemistry,  $N=12$ ).

## 3. Findings and Analysis

### 3.1. Existing Literature

There is a large amount of literature on the topic of risk analysis, risk assessment, risk perception, and how social and cultural identity affects an individual's judgment of riskiness. Risk is defined as the potential that a chosen action will lead to a loss or undesirable outcome. Slovic [14] identifies two

primary factors that influence risk perception: “dread risks” which are characterized by how much a person perceives there to be a lack of control, dread, catastrophic potential, fatal consequences, and the inequitable distribution of risks and benefits; and “unknown risks” which are characterized in terms of a person’s assessment of how unobservable, unknown, new, and delayed the risk is in its manifestation of harm.

Cost is considered to be the loss or penalty incurred in the process of something being gained. Many researchers treat costs and risks as overlapping constructs. Research in the area of argumentation of socio-scientific issues suggest that individuals often selectively credit or dismiss evidence of benefits, costs, and risks based on personal values that they share with others rather than on scientific knowledge [15]. In the context of science education, science learners have been found to rely on emotive, intuitive, and rationalistic resources when analyzing socio-scientific issues, independently of their level of content knowledge about a subject [16]. Changes in students’ ability to generate high-quality costs, benefits, and risk analyses seem to vary in a non-linear fashion with content knowledge acquisition [17].

Decision theory, upon which much research in economics, mathematics, and philosophy is based, provides a means for logical analysis in making decisions among alternatives [13], and is described in more detail in section 3.2.2 below.

### 3.2 Experimental Findings

Written survey responses and transcriptions of audio-recorded interviews are being coded using an open-coding strategy [18]. While small sample size hinders the ability to perform a quantitative analysis of the codes, some preliminary qualitative conclusions have been drawn.

Initially, it was observed that interviewees generally followed a consistent pattern of reasoning:

*Compound [X] is [best/worst] because [primary factor] is the most important [risk/benefit] because [primary factor reason]. The [secondary factor], which is a [risk/benefit], must also be taken into consideration, but is not as important as [primary factor] because [secondary factor reason]. The tradeoff is [tradeoff reason].*

Some individuals indicated a single ‘factor’ influencing their decision. For these individuals, the statements provided about the compounds in the case study appeared to be taken at face value as either a risk or a benefit, but not as having characteristics of both. This dichotomous assignment of information as either negative or positive was a characteristic primarily displayed by individuals with little formal training in chemistry.

Further examination of the interview data and comparison to relevant literature in risk analysis decision making [15, 19] led to the articulation of two candidate progress variables along which students’ assumptions may be characterized in terms of sophistication: (a) proximity to self and (b) complexity of analysis.

#### 3.2.1 Proximity to Self Progress Variable

Proximity to self includes both spatial as well as temporal sub-variables (Figure 2). Along the temporal variable, study participants reasoned with some or all of a range of time scales from immediate effects (now) to forthcoming effects (soon) to effects within the individual’s lifetime, and finally to effects on future generations. Along the spatial variable, study participants indicated reasoning about impacts to self, surroundings, and/or global scale. Individuals who demonstrated reasoning at distal proximities (i.e. future generations and global impacts) also indicated reasoning at closer proximities (i.e. now and self) but the reverse was not necessarily true.



### 3.2.2 Complexity of Analysis Progress Variable

The second progress variable is analyzed through the way in which the participant advances an explanation. While coding interview transcripts, it became apparent that individuals exhibited one of two inclinations toward the data: *optimistic*, in which the respondent primarily compared the benefits of each option, or *pessimistic*, in which the respondent primarily compared the risks of each option.

Decision theory provides an accounting of the logic for each of the possible decision paths. Two main branches of decision theory exist: 1) decision under uncertainty in which alternative courses of action have outcomes with unknown probabilities of occurrence, and 2) decision under risk in which the probabilities of occurrence of particular outcomes is known. Decision-making in environmental systems typically exists as decision under uncertainty. Within this branch, three decision paths exist, depending on what is compared. Table 1 illustrates the application of decision theory along the three types of decision paths. A *maximin* decision maker pursues a decision in which the detriment of the outcome is minimized (Table 1a). Such an individual, therefore, could be considered a pessimist, arguing based on acceptance of a worst-case scenario and making a decision where the consequences are minimized. For example, consider the response to the question of which compound is best and why offered by a participant who compared the risks associated with each course of action (note: participant-selected code names are included in square brackets following each quote):

*“HFE7100 is my clear choice in this decision, as hydrofluorinated ethers are known to not harm the ozone layer nor humans nearly as much as the other two options.”*  
[QuirkyChemist007]

A *maximax* decision maker pursues a decision in which the benefit of the outcome is maximized (Table 1b). Such an individual could be considered an optimist, determining the benefits of each outcome and making a decision in which the benefit is maximized. For example, consider the following response to the same question:

*“I believe HCFC 141b should be chosen simply b/c [sic] it has already been used and [it is] cost effective and reliable.”* [Boom123]

A *minimax regret* decision path, also known as an opportunity loss path, compares differences between the actual outcome and the better position that could have been attained if a different course of action had been chosen, and argues for choosing the option with the least difference (Table 1c).



**Table 1a. Maximin.** This decision maker shows evidence of a pessimistic outlook, considers the consequences, and selects the least worst consequence. The highlighted boxes indicate the choices that have the least worst consequence within each category of consideration.

		<b>Consequences</b>		
		<i>Cost (\$)</i>	<i>Environmental detriment</i>	<i>Human health risk</i>
<b>Choices</b>	<i>HCFC</i>	Medium	Medium	Lowest
	<i>HFE</i>	High	Unknown If dread high, then high If dread low, then lower	Low (this is a mild irritant)
	<i>SO<sub>2</sub></i>	Low mfg price	High	High

**Table 1b. Maximax.** This decision maker shows evidence of an optimistic outlook, considers the positive outcomes, and selects option with the best positive outcome. The highlighted boxes indicate the choices that have the most beneficial outcome within each category of consideration.

<sup>a</sup>Global Warming Potential. <sup>b</sup>Ozone Depletion Potential

		<b>Possible outcomes</b>		
		<i>Profit (\$)</i>	<i>Lack of environmental detriment</i>	<i>Lack of human health risk</i>
<b>Choices</b>	<i>HCFC</i>	Medium	Big GWP <sup>a</sup> and ODP <sup>b</sup>	None
	<i>HFE</i>	Most expensive	No GWP No ODP	Mild irritant, Non-toxic
	<i>SO<sub>2</sub></i>	Cheapest	Acid rain, smog	Very toxic

**Table 1c. Minimax Regret.** This decision maker shows evidence of reasoning according to opportunity losses (the difference between the actual outcome and the better position that could have been attained if a different course of action had been chosen) and selects the option with minimum regret.

		Proportional regrets		
		Cost (\$)	Environment	Human health
Choices	HCFC	Medium	If value future, then high regret If only value present, then low regret	Low regret
	HFE	Large regret	Amount of regret depends on dread: If high dread, then high If low dread, then low	Medium
	SO <sub>2</sub>	Least regret	If value present only, then high regret	Large regret

### 3.2.3 Personal Positions that Influence Individuals' Application of Assumptions

Several influencing factors were predicted by findings of literature reviewed. Kahan et al. [15] and Finucane et al. [19] found correlations in risk perception with gender, ideological and social values, prior knowledge (either via formal education or from past experiences), self-perception of how much knowledge an individual has (and confidence in that knowledge), and an individual's level of dread associated with the phenomenon. The maps of possible pathways of reasoning for each decision path in Table 1 were used to identify the decision pathway used by each participant, and to ascertain the presence or absence of elements of logic comprising the rationale presented for why one compound is best to use. Once the participant's logic was unpacked, the mapping to a decision path made it possible to discern the level of dread (if maximin or minimax regret) and degree of reliance on various timescale arguments in the temporal proximity progress sub-variable (if minimax regret). Additional questions in the survey and interview protocol allowed for triangulation of these factors, and for a window into the other factors for each individual.

## 4. Contribution to the Teaching and Learning of Science

A survey of practicing chemists, both academic and industrial, would likely indicate that the field is striving to advance along a more environmentally sustainable trajectory. This new direction of chemistry is referred to as *green chemistry*. In their book, *Green Chemistry: Theory and Practice* [24], Anastas and Warner outline 12 principles that represent the core ideals of the science. Because it is often difficult to uphold all of these principles at the same time, chemists must rely upon their ability to analyze outcomes and take a course of action which they feel best represents the practice.

The success of the next generation of green chemists, therefore, will depend on their ability to analyze the benefits, costs and risks and to appropriately reason about the outcomes, both intended and unintended, of their decisions. In order to facilitate this progression, we believe that it is crucial for chemical educators to understand and assist young chemists with these types of reasoning skills. By uncovering the implicit assumptions that students make about BCR reasoning, it is hoped that an appropriate curriculum can be

devised to advance novices in along the progress variables discovered here until those novices can be considered experts in their reasoning abilities.

### Acknowledgements

This work was funded in part by the National Science Foundation (NSF) EHR-0412390. Any opinions, findings, conclusions or recommendations expressed are those of the authors and/or those whose work is drawn upon, and do not necessarily reflect the views of the NSF.

### Literature Cited

1. T. Corcoran, F.A. Mosher, A. Rogat, Learning progressions in science: An evidence-based approach to reform. Consortium for Policy Research in Education Report #RR-63. Consortium for Policy Research in Education, Philadelphia 2009.
2. National Research Council (NRC), Taking science to school: Learning and teaching science in grades K-8. Duschl, R. A., Schweingruber, H. A., & Shouse, A, (Eds.). National Academies Press, Washington, D.C., 2007.
3. C. Smith, M. Wiser, C. Anderson, J. Krajcik, *Measurement*, 2006, 14, 1.
4. S. Stevens, C. Delgado, J. Krajcik, (2010). *J Res. Sci. Teach.*, 2010, 47, 687.
5. C. Smith, S. Carey, M. Wiser, *Cognition*, 1985, 21, 177.
6. L. Mohan, J. Chen, C.W. Anderson, *J. Res. Sci. Teach.*, 2009 46, 675.
7. A. Alonzo, J.T. Steedle, *Sci. Educ.*, 2008, 93, 389.
8. R.G. Duncan, A. Rogat, A. Yarden, *J Res. Sci. Teach.*, 2009 46, 655.
9. R. Lehrer, L. Schauble, *Sci. Educ.*, 2012, 96, 701.
10. L. Berland, L. McNeill, *Sci. Educ.*, 2010, 94, 765.
11. T. Sikorski, D. Hammer, *Learning in the Disciplines: Proceedings of the 9th International Conference of the Learning Sciences*, 2010, 1032.
12. V. Talanquer. *J. Chem. Ed.*, 2006, 83, 811.
13. D.W. North, *IEEE Transactions on Systems Science and Cybernetics*, 1968, SSC-4, 200.
14. P. Slovic, *Saúde Soc. São Paulo*, 2010, 19, 731.
15. D. Kahan, H. Jenkins-Smith, D. Braman, *J. Risk Res.*, 2011, 14, 147.
16. T.D. Sadler, L.A. Donnelly, *Int. J. Sci. Educ.*, 2006, 28, 1463.
17. T.D. Sadler, S. Fowler, *Sci. Educ.*, 2006, 90, 986.
18. M.Q. Patton, *Qualitative Research and Evaluation Methods*, 3<sup>rd</sup> ed. Sage Publications, Thousand Oaks, CA 2002.
19. M.L. Finucane, A. Alhakami, P. Slovic, S.M. Johnson, *J. Behav. Decis. Making*, 2000, 13, 1.
20. P.T. Anastas, J.C. Warner, J. C.; *Green Chemistry: Theory and Practice*, Oxford University Press, New York, 1998.

# Impact of Facilitated Study Groups on Student Learning in 2<sup>nd</sup> year Organic Chemistry Courses

Shadi DALILI, Allyson SKENE

*Department of Physical and Environmental Sciences, University of Toronto Scarborough 1265 Military Trail  
Toronto, ON Canada M1C 1A4*

*Email: sdalili@utsc.utoronto.ca T: 416-287-7215 F: 416-287-7279*

## Introduction

Organic chemistry courses are considered by many students as among the most challenging science courses at the university level. At the University of Toronto Scarborough (UTSC), all students in major and specialist programs in Chemistry, Biological Chemistry, Environmental Chemistry, Biochemistry, as well as many biology programs, must take two semesters of organic chemistry with laboratories in order to graduate from their respective programs. Many of these students require high grades in these courses for entrance into graduate and/or professional schools. Thus, due to the significant role these courses play in the students' academic success, and considering the high rates of attrition and low course averages in our 2<sup>nd</sup> year organic chemistry courses, Facilitated Study Groups (FSGs) were implemented for the second year undergraduate organic chemistry courses (CHMB41H & CHMB42H) at the University of Toronto Scarborough starting in January 2009.

Facilitated Study Groups (FSGs) are a program offered through the Center for Teaching and Learning (CTL) at the University of Toronto Scarborough as a form of supplementary learning, to enhance the student experience, reduce attrition, and help students succeed in historically difficult courses, such as organic chemistry. FSGs provide a structured study environment that allows students in targeted courses to learn effective study strategies for mastering their course material.

## Structure and Pedagogy

The topics covered in CHMB41 as part of our organic chemistry curriculum are: families, naming, and properties of organic molecules; acid-base reactivity, stereochemistry, and substitution, elimination, addition, and radical reactions of various functional groups. There are 36 hours of classroom lecture and 20 hours of laboratory instruction. The methods of assessment used for the final course grade consist of two midterms (30%), one final exam (37%), laboratory experiments and exam (25%), 10 online homework assignments (5%), and clicker participation marks (3%).

The most challenging topics and content for students are stereochemistry and visualizing molecules in three dimensions, as well as learning the numerous reactions, mechanisms, and reagents and being able to distinguish where and how to apply these reactions and mechanism in synthesis. Thus, due to the sheer volume of content and its complexity, many students resort to memorization of the material. However, it is impossible to fully understand and apply organic chemistry knowledge to unique situations and problems through memorization; thus, in this regard, the FSGs have been invaluable in teaching students alternative methods for learning and understanding difficult concepts.

The FSG pedagogy is based on the Supplemental Instruction (SI) model developed by Dr. Deanna Martin in 1973 at the University of Missouri at Kansas City [1]. The goal is to encourage independent learning in students by pushing them to move beyond memorization and reliance on authority, and to develop good study habits and critical thinking skills [2]. This model is based on principles from psychological and learning theory, which emphasize positive reinforcement, where student success will reinforce good study practices [3], cognitive development principles, that demonstrate the need to integrate new information with prior knowledge in order to improve overall understanding [4], and active learning, which emphasi-

zes the need for learners to engage with material, make mistakes and develop solutions to problems [4]. Significant data show student participants in study sessions based on this model have higher final course grades, withdraw less often from courses [5] and have higher reenrollment and graduation rates [6].

The major goals of the FSG program at UTSC are to a) improve student learning and b) reduce rates of attrition. The uniqueness of the program is that it is a *voluntary* support program targeting historically difficult courses, rather than “at-risk” students, that provides regularly scheduled, out-of-class, peer facilitated sessions that are open to *all* students in the course.

Depending on the course enrollment per semester, 1-2 trained student facilitators provide two to four, 50-minute study sessions per week. The schedules of the sessions are determined by an online survey of the class, to provide the most appropriate times without conflicts with other class schedules.

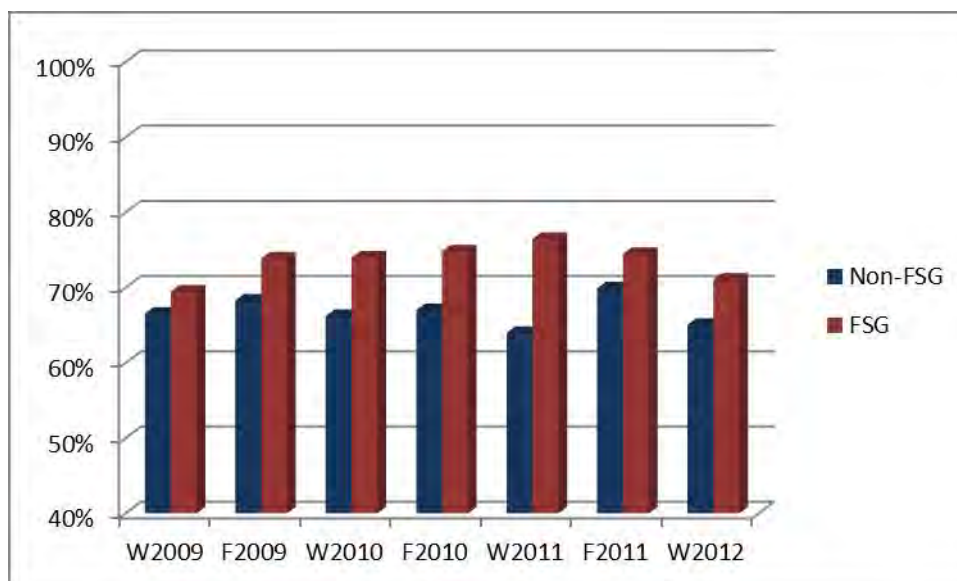
The facilitators of the FSGs are former students who have demonstrated competence in the specific or comparable course, and can guide students in learning appropriate study strategies, such as note taking, graphic organization, questioning techniques, vocabulary acquisition, and test preparation. They are usually recommended by the instructor of the course to the coordinator of the program at the Center for Teaching and Learning. Those selected as facilitators participate in a two-day training session to learn new study strategies and approaches that would appeal to different types of learners, and to think about how to design activities that would allow students to fully engage with, and process the material independently. Follow-up training occurs throughout the term. Facilitators also attend lectures, both to model the behavior and practices of effective students and to give them an opportunity to prepare for their study group sessions. Facilitators do not re-lecture any content of the course, but direct collaborative learning exercises that encourage students to take responsibility for processing course content from lectures.

The various types of activities developed by the facilitators for the study sessions consist of worksheets and group exercises geared toward active learning. For example, one favourite activity is matching cards where students must collaborate to match reactants with correct products or IUPAC names with structures. Not only do students appreciate the opportunity to move around to different groups and talk to new people, they benefit from actively working together to discover the principles behind the reactions. Another example is the incomplete matrix, where students work together to chart comparisons between similar reactions such as  $S_N2/S_N1$  and  $E2/E1$  to name a few. Students were enthusiastic about these activities because they enabled them to understand *how* the reactions worked, as well as recognize conditions under which each reaction was dominant. They also appreciated that once completed; they could use these matrices to study from for tests and exam, or as a guide to develop their own charts.

### Results of FSGs

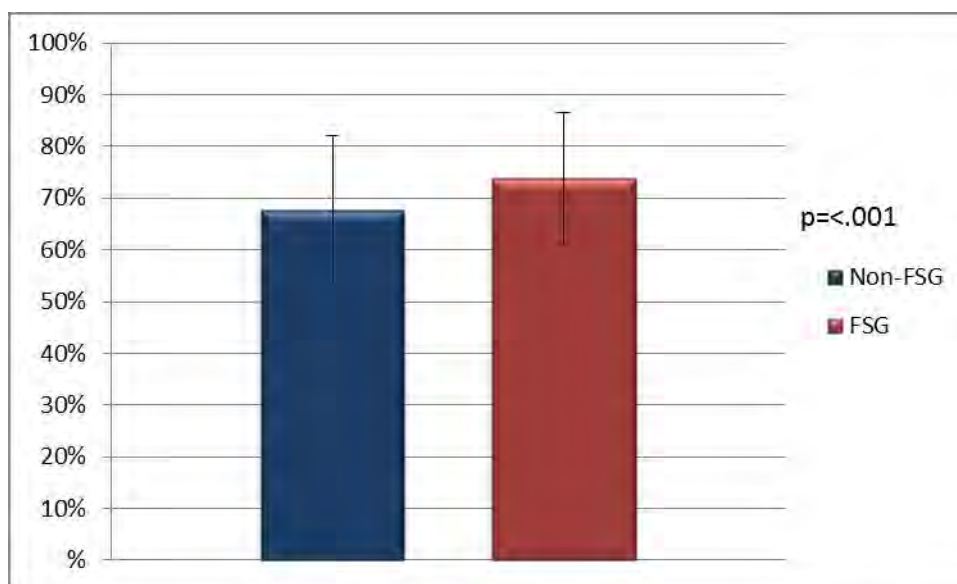
For the purposes of this paper, we have focused our attention and statistical analyses of the FSG data on the second year undergraduate organic chemistry course (CHMB41H) offered in both the Fall and Winter semesters each academic year. The enrollment for the Fall semester averages between 370-450 students, while the Winter semester enrollment is approximately 95-120 students.

The FSGs sessions have been implemented every semester in CHMB41H as of Winter 2009 (7 semesters total). Attendance has ranged from 22% of a given class to as high as 67%, with an overall average of 34% of students taking CHMB41 since Winter 2009 attending FSGs. As can be seen in Figure 1, these attendees consistently had higher course averages than those who did not utilize this resource.



**Figure 1** Comparison of mean final grade (%) for FSG attendees and non-attendees in Introductory Organic Chemistry per term

Across all semesters, the difference in course average was the difference in a letter grade, as shown in Figure 2.

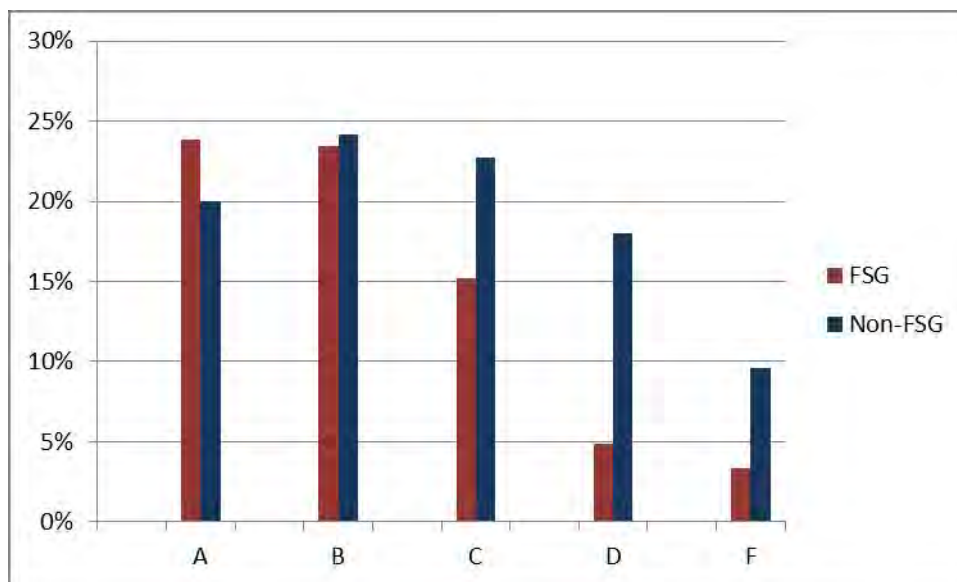


**Figure 2** Comparison of mean final grade (%) for FSG attendees and non-attendees in Introductory Organic Chemistry over ALL terms

Figure 2 shows that the course average for students not attending FSGs was a C+ (67.8%), below the overall class average of 69.5; while the course average for students attending FSGs was a B- (73.8%), and this difference is statistically significant on T-test ( $p < .001$ ), indicating that the study strategies and activities taught in FSGs had tremendous benefit for the students and resulted in higher grades for those attending the sessions.

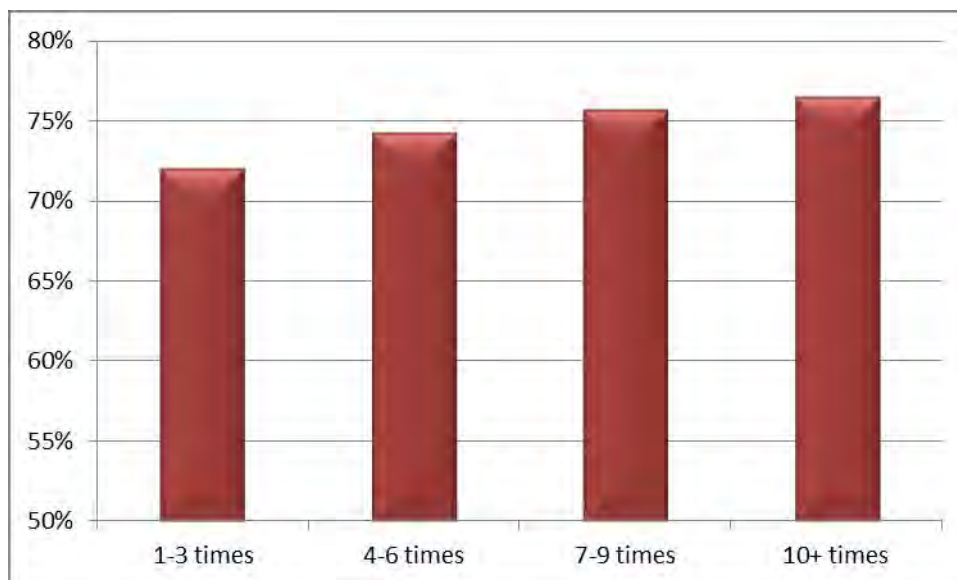
Further indication that the difference in mean grade is not simply a product of outliers with a high average

can be seen in the grades distribution patterns, shown in Figure 3. As can be seen in Figure 3, the grades distribution patterns of non-attendees approximates a typical bell curve, while the distribution of the FSG participants is much more heavily skewed to the higher grades. This distribution is even more remarkable in light of evidence that typically top-performing students tend not to attend these study groups [7]. End-of-term surveys asking CHMB41 students about their reasons for not attending FSGs confirm this, as students who are expecting to receive an 'A' in the course often respond that they did not attend because they "did not feel that it was necessary".



**Figure 3** Comparison of letter grades for FSG attendees and non-attendees in CHMB41

Further evidence that results are not a product of sample bias is the correlation between average grade of students attending FSGs and the number of times they attended ( $r=.13$  across all terms).

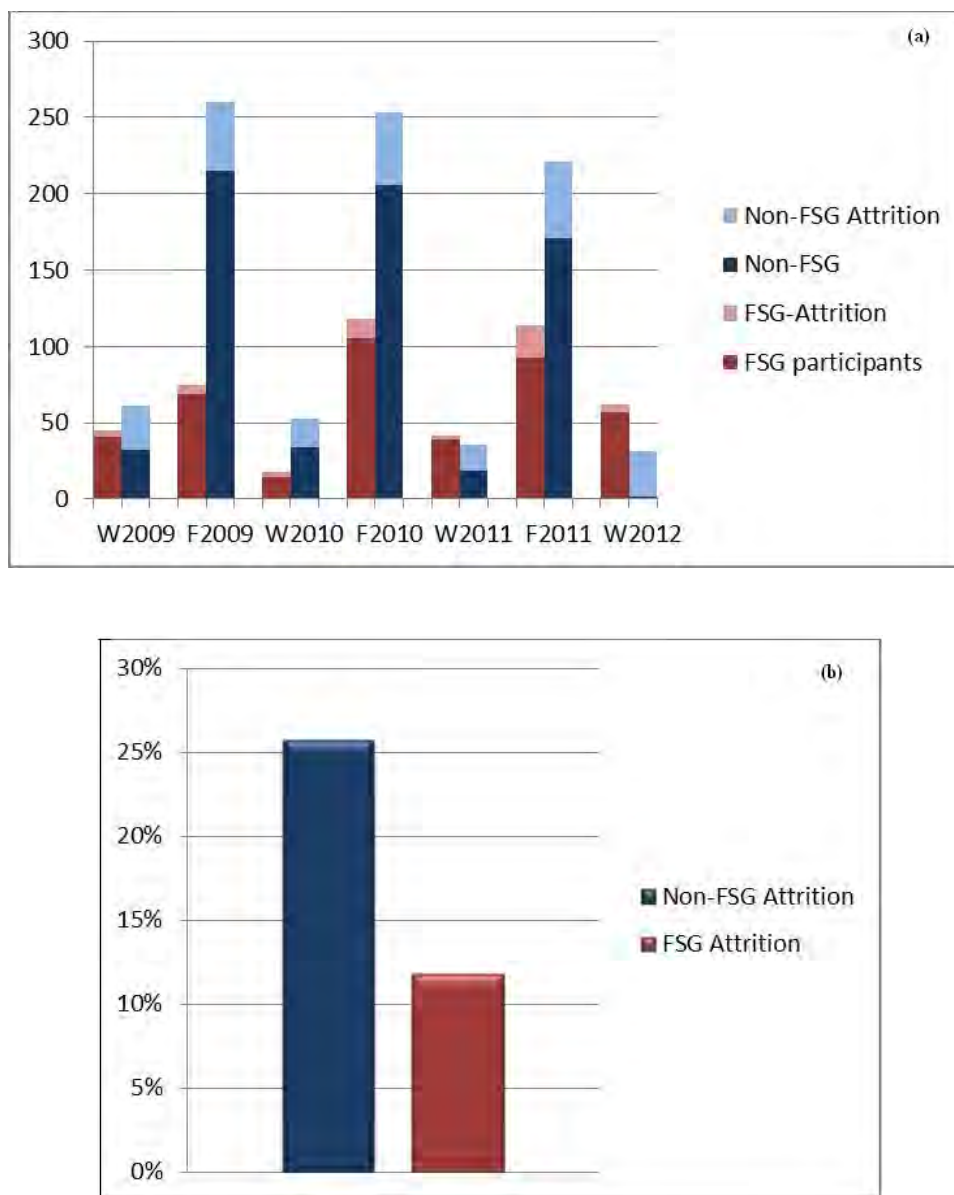


**Figure 4** Mean final grades of FSG participants vs number of FSG sessions attended

As seen in Figure 4, the data suggest that those who attend regularly benefit more from FSGs than those who do not. Those who attended 1-3 sessions scored an average of 72%; those who attended 4-6 sessions scored an average mark of 74%; those who attended 7-9 sessions had an average grade of 75.7%; and

those attending *more than 10* sessions had an average of 76.5%. While the correlation is not uniform across terms, it is consistently positive in each term, and reached a high of  $r = 0.31$  in Fall 2010. In addition, the effect size, while often small, is measurable ( $d = .22$  across all terms, and up to  $d = .53$  in Winter 2011). Taken together, these stats indicate that the FSGs do help students to succeed in Organic Chemistry.

In addition, one of the major goals of FSG sessions is to reduce the attrition rates amongst students; thus, we analyzed data comparing attrition rates for students attending FSG sessions versus non-attendees. The results are shown in Figure 5.



**Figure 5** Comparison of attrition rates for FSG attendees and non-attendees in Introductory Organic Chemistry each term (a) and over ALL terms (b)

As seen in graph (a), the attrition rate for non-attendees is significantly higher than those attending FSG sessions, and averaging 15% higher when all semesters are considered (graph b). From these findings we can conclude that the activities provided in FSG sessions increased students' engagement with, and enthusiasm for, the course material, resulting in fewer students leaving the course.

In order to gauge students' perceptions of the FSG sessions, surveys were conducted at the end of each semester asking students to rate the helpfulness of the sessions attended, the degree of engagement provi-



ded by the facilitator, and the likelihood of the student attending other FSG sessions in other courses, based on a 5 point scale, with 1 being “very poor/very unlikely” and 5 being “excellent/extremely likely”. Over the course of all 7 semesters, the majority of students (70-80%) have consistently ranked the sessions and the engagement provided by the facilitators with 4/5 and 5/5 on the end of term surveys, showing their satisfaction with the FSGs and their appreciation regarding the helpfulness of the sessions in fulfilling the students’ goal of achieving high grades in a historically difficult course.

As an example, one comment from a student on one of these surveys was:

“FSGs are extremely useful, they allow one to practice questions in a group setting, and allow others to answer questions that a person may not have been able to answer themselves, and offer explanations.”

Not only do the FSG sessions benefit the students taking the course, they are also quite beneficial to the facilitators themselves, as they learn valuable transferable skills such as organization, communication, collaboration, as well as time and classroom management.

A profound statement from one of the facilitators from the Winter 2009 semester:

“Working as a facilitator, I gained an understanding of how much *diversity* there is in how people learn. Appealing to every learning style is very difficult in a lecture setting, but in the small group setting of FSGs, we can *capitalize on each student's strengths*. FSGs give students a chance to *participate without the fear* of being wrong or not looking smart. *Working in groups* allows students to solve problems using more than one strategy because each individual has a slightly different approach. Then, they can *apply these new skills* when studying at home, working in the lab, or writing the exam. This experience really taught me how to be an *active learner*, and it is true when people say that *the best way to truly learn is to teach*. One of the most beneficial parts of FSGs is that the *students learn to ask each other for help* because everyone brings a different set of skills to the FSG.” [Emphasis added.]

In this one statement, our facilitator has summed up all our goals for the FSG sessions and our aspirations for our students; namely, to become active learners, to be able to apply study skills to new situations, and to be able to work in groups and learn from each others’ strengths. We would like to think we have been able to achieve most of our goals for the FSG sessions, as most of the students attending the sessions have succeeded in the course. In addition, FSGs have provided motivation for our students to engage with and master the course content, as many students want to become FSG facilitators themselves in subsequent semesters. Our future goals are to expand these sessions into more courses at the University of Toronto Scarborough to reach even more students.

## Acknowledgements

We would like to thank all our student facilitators and attendees, as well as Janice Patterson from the Center of Teaching and Learning at the University of Toronto Scarborough for statistical data and organization of the FSG sessions. We also express our gratitude towards CTL for providing the funding for FSG sessions.

## References

- [1] Arendale, D., Martin, D. C. (1997). *Review of research concerning the effectiveness of Supplemental Instruction from the University of Missouri-Kansas City and other institutions*. Kansas City, MO: The University of Missouri-Kansas City. (ERIC Document Reproduction Service No. ED 370 502)
- [2] Hurley, M., Jacobs, G., Gilbert, M. *New Directions for Teaching and Learning*, 2006, DOI: 10.1002/tl
- [3] Epstein, R. *Skinner for the Classroom: Selected Papers*, Champaign, Ill., Research Press, 1982.
- [4] Vygotsky, L. S. *Thought and Language*. (A. Kozulin, trans.) Cambridge: Massachusetts Institute of Technology Press, 1986.
- [5] International Center for Supplemental Instruction. (2007). *Supplemental Instruction (SI) National Data Fall 2003-Fall 2006*, University of Missouri-Kansas City. Retrieved from <http://www.umkc.edu/cad/SI/publications.shtml>
- [6] R. A. Blanc, L. DeBuhr, D. C. Martin, *Journal of Higher Education*, 1983, 54(1), 80-89
- [7] T. J. Bowles, J. Jones, *Journal of College Student Retention*, 2003/2004, 5(2), 235-243.

## Exploring Primary Student Teachers' Conceptions of Size-Dependent Properties at the Nanoscale

Dimitrios STAVROU<sup>1</sup>, Manfred EULER<sup>2</sup>

<sup>1</sup>Department of Primary Education, University of Crete, 74100 Rethymno, Greece

<sup>2</sup>Leibniz-Institute for Science and Mathematics Education (IPN), University of Kiel, D-24098 Kiel, Germany  
e-mail: dstavrou@edc.uoc.gr; Tel.: +302831077585

### Abstract

*Apart from the rapid development of nanoscience that impacts on many areas of technological and societal development there are many more reasons to provoke the science educators' interest to investigate ways of introducing basic ideas of this area into school science curricula. From an educational point of view, understanding the emergence of novel mechanical, optical, electric, magnetic, thermal, chemical and biological properties at the nanoscale is a central challenge. It is deeply linked with the learners' conceptual development progressing from the simple to the complex. The present investigation focuses on students' conceptions of size-dependent properties at the nanoscale. In a small group setting of 2 students each, twenty six primary student teachers' capabilities and difficulties in understanding the scientific point of view were investigated, using a teaching experiment design. The different colors of Cadmium Selenide due to the different size of nano-grains were discussed during the interviews. The results show that student-teachers did not have any idea about size-dependent properties but they readily accepted this idea when the relevant information was provided. Nevertheless they had difficulties in explaining the color change of CdSe in terms of surface/volume ratio and of energy levels quantization. These difficulties seem to be connected with their ideas of "fixed properties of objects" and "continuity of matter in all scales".*

**Keyword:** nanoscience, size-dependent properties, pre-service teachers, teaching experiment

### Introduction

The rapid development of nanoscience as a scientific field where the classical domains like physics, chemistry and biology converge and meet at the atomic or molecular level, provokes the science educators' interest to introduce basic ideas of this area into the school science curriculum [1]. The emergence of novel mechanical, optical, electric, magnetic, thermal, chemical and biological properties at the nanoscale as compared to bulk behavior [2] seems to be a valuable general insight from an educational point of view [3]. For instance, colloidal suspensions of gold nanoparticles exhibit different colors at the nanoscale depending on particle size. Assuming that nanoscale conceptions held by teachers will affect those of their students in a review of the science education literature one faces a need for research - at least research that links content matter and educational issues - regarding teacher education [4]. The work presented here takes into account the need for teacher training in a new scientific field and focuses on size-dependent properties at the nanoscale. In particular the aim of the present study is to investigate primary student teachers' conceptions of size-dependent properties at the nanoscale.

### The Study

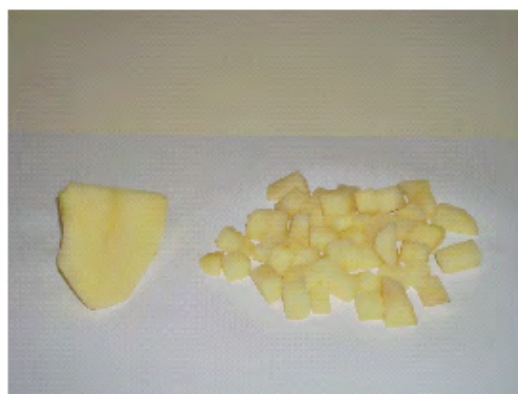
In order to collect the data the teaching experiment approach was applied [5]. Teaching experiments may be viewed as Piagetian critical interviews deliberately employed as teaching and learning situation. The interviewer takes both the roles of a "classical" interviewer, who attempts to understand learners' individual conceptions, and of a teacher, who has to react to learners' conceptions and has to make the appropriate intervention at just the right moment. In a small group setting, twenty six pre-service teachers in their second year of their studies in the Department of Primary Education at the University of Crete, in Greece, took part in the study attending 13 groups of 2 students each. These students have a good back-

background in pedagogical issues but a limited background in science and mathematics. When the study was carried out, the students had already attended at the university a course about basic concepts of physics and a course about the methodology of teaching science. After their graduation the students are going to teach in primary school (age 6-12) a wide range of subjects like greek language, mathematics, history. In the 5<sup>th</sup> and 6<sup>th</sup> grades they are required to teach science, an integrated subject with phenomena and basic concepts of the fields of physics, chemistry and biology. The interviews lasted approximately 70 minutes and were audio-taped and transcribed. Due to the explorative nature of the study, methods of qualitative research were used to analyse the data. The main points of the interviews could be summarized to the following:

- Discussion about properties, reasons of having different properties in materials and the possibility to change the materials' properties.
- Expectations and explanations of the behaviour of a steel nail, steel wire and steel wool after trying to burn them (Fig. 1). Discussion about if there is a change of the properties.
- Expectations and explanations of the behaviour of a piece of potato and of small pieces of another potato (Fig 2) after reacting with hydrogen peroxide ( $H_2O_2$ ) (Fig.3). Discussion about if there is a change of the properties.- Demonstration of a picture that exhibit the different colors of Cadmium Selenide grains (CdSe) at the nanoscale (Fig. 4). Initial attempts to explain the different colors.
- Identification of the size of the grains as the reason of color change. Development of analogous relationships between the steel experiment, the potato experiment and the different colors of CdSe and explanations of the different colors.
- Development of a representation of size dependent properties at the nanoscale. Reflection on their own representations about the change of the properties



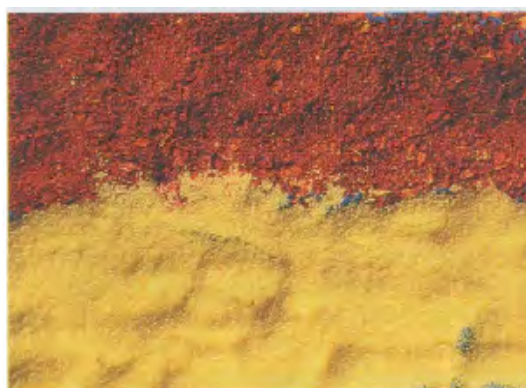
**Figure 1** Steel nail (left), steel wire (middle) and steel wool (right)



**Figure 2** A piece of potato (left) and another potato cut into small pieces (right)



**Figure 3** Same as Fig. 2 reacting with  $H_2O_2$



**Figure 4** The substances are Cadmium Selenide. The only differences is the grain' size (Halliday et al 2001)

## Results

The data analysis demonstrated that none of the students expressed the idea of size dependent properties. When the relevant information was given by the interviewer the students were surprised but they did not have any objections to the fact that the different colors of the Cd-Se are due to the different size of grains. Nevertheless they had difficulties in explaining the color change of CdSe in terms of Surface/Volume ratio [comp. 6] and of Energy Levels Quantization [comp. 7]. Although students used the idea of the surface increase in order to explain the properties of the potato when it was cut to small pieces, they did not use it when they were asked to explain the color changes in CdSe. Furthermore, students had difficulties in recognizing the change of the energy levels and the increase of energy level difference as the size of the CdSe becomes smaller. They were not able to establish a connection with the different colors, even though aids in form of an image with the spectrum of the visible light and a table with colors, complementary colors and corresponding wavelengths was given to them.

In summing up the students' efforts to interpret the color changes at the nanoscale two major conceptual stumbling blocks seem to cause difficulties:

The first one is based on their idea that "objects have fixed properties" [comp. 8; p.12]. For example as a discussion was triggered by the interviewer about the change of the colors of materials most of them indicated that a material has a fixed color (usually the one that is visible in the sunlight). The change of colors is usually explained in terms of humans' perception and not as a "real" change in the properties of the material that interact with the incoming light.

The second one has to do with the fact that they explain the phenomena in terms of "continuity". Most of the students believe that properties remain invariant at all scales and they mainly interpret the macroscopic behavior in an additive framework [comp. 9]. The change of properties as we reach the nanoscale causes difficulties as it indicates a "discontinuity". At the nanoscale students have to think in terms of the quantum theory in order to give satisfying physical explanations of the phenomena. In other words, a thorough top-down approach or a bottom-up approach seems to cause considerable difficulties as different levels of physical theories have to be matched (i.e. newtonian and quantum mechanics). A combination of these two approaches (top-down and bottom-up) seems to be more valuable as nanoscale phenomena may be used as a "transition area" between newtonian and quantum mechanics. This may also provide a connection between newtonian and quantum mechanical worlds and their conceptual clashes, which is an important part of developing an understanding of the two models [10; p.706].

## Conclusions

This study offers an insight on pre-service teachers' conceptions about size-dependent properties. Nevertheless, due to the explorative character of this study the results have a hypothetical character. They should be tested in a broader sample. Based on the structure of the teaching experiment of this study a questionnaire has been developed. In order to acquire data from different background student-teachers, physics and chemistry students have been called to fill the questionnaire online. We expect to gain valuable insights about student teachers' conceptions with different background in science in order to develop teaching –learning sequences about teaching size dependent properties at the nanoscale at the university level.

## References

- [1] B. Hingant B., V. Albe, Nanosciences and nanotechnologies learning and teaching in secondary education: a review of literature. *Studies in Science Education*, 2010, 46, 121–152
- [2] M.C. Roco, Nanoparticles and nanotechnology research. *Journal of Nanoparticle Research*, 1999, 1, 1–6.
- [3] S. Stevens, L. Sutherland, J. Krajcik, The 'big ideas' of nanoscale science and engineering. Arlington, VA: National Science Teachers Association press, 2009
- [4] N. Healy, Why Nano Education? *Journal of Nano Education*, 2009, 1, 6–7.
- [5] M. Komorek, R. Duit, The teaching experiment as a powerful method to develop and evaluate teaching and learning sequences in the domain of non-linear systems *International Journal of Science Education*, 2004, 26, 619-633
- [6] A. Taylor, G. Jones, Proportional Reasoning Ability and Concepts of Scale: Surface area to volume relationships in science, *International Journal of Science Education*, 2009, 31, 1231-1247

- [7] D. Halliday, R. Resnick, J. Walker, Fundamentals of Physics. New York: Wiley, 2001
- [8] K. Dimitriadi, K. Halkia. Secondary Students' Understanding of Basic Ideas of Special Relativity. International Journal of Science Education, 2012, DOI:10.1080/09500693.2012.705048
- [9] V. Talanquer, Students' Predictions About the Sensory Properties of Chemical Compounds: Additive Versus Emergent Frameworks, Science Education, 2008, 92, 96-114
- [10] S.Y. Stevens, C. Delgado, J.S. Krajcik, Developing a Hypothetical Multi-Dimensional Learning Progression for the Nature of Matter, Journal of Research in Science Teaching, 2010, 47, 687-715

# Pólya's Strategies For Mathematical Problem Solving And IUPAC Nomenclature of Organic Compounds: An Analogy

Flora TEIXEIRA e COSTA

*Faculdade de Ciências da Saúde, Universidade Fernando Pessoa,  
R. Carlos da Maia 298, 4200-150 Porto, Portugal  
florac@ufp.edu.pt*

## Abstract

*Chemists have always developed complex symbolic systems to describe the submicroscopic level (Johstone 1982, 1993) and the observed macroscopic phenomena. Symbolic systems are communication bridges between the submicroscopic level and the macroscopic one. They are an intrinsic need of the human being to think, better understand nature and continue questioning it.*

*The purpose of this paper is to propose Pólya's strategies for mathematical problem solving (Pólya, 1945) as an analogue strategy to IUPAC's nomenclature name attribution of simple organic compounds.*

## Riassunto

*Chimici hanno sempre sviluppato complessi sistemi simbolici per descrivere il livello submicroscopica (Johstone 1982, 1993) e il fenomeno macroscopico osservata. Sistemi simbolici sono ponti di comunicazione tra il livello submicroscopica e quella macroscopica. Essi sono un bisogno intrinseco dell'essere umano di pensare, di meglio comprendere la natura e continua a mettere in discussione lo.*

*Lo scopo di questo documento è quello di proporre di Pólyastrategie per la matematica problema solving (Pólya, 1945) come una strategia analogica alla attribuzione di nome nomenclatura di IUPAC di composti organici semplici.*

## Introduction

IUPAC, International Union of Pure and applied Chemistry was formed in 1919 by chemists from industry and academia, seven years after Pólya obtained his PhD in mathematics. Over the years IUPAC united academic, industrial and public sector chemistry in a common language and is the world's authority on chemical nomenclature of organic compounds, which will be the subject of this paper.

This is a complex issue and very few chemists deeply understand the intricacy of nomenclature conventions.

Regardless of this complexity, the issue of nomenclature of organic compounds can be looked at as an algorithmic problem to be solved rather than a conceptual problem. Cracolice and *al.* (Cracolice, 2008) claimed that an algorithmic problem is one that can be solved using a memorized set of procedures, as opposed to a conceptual one that needs to be worked from an understanding of a concept to the solution to the problem.

Taking this into account, to name an organic compound after IUPAC's conventions or the reverse, to be able to draw a structure after the IUPAC name of a compound, is in fact an algorithmic task but without doubt it is a crucial because enables chemists to have a clear picture of the organic compounds in order to deduce its chemical or physical properties.

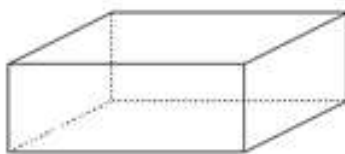
## Discussion

As mentioned, naming organic compounds after IUPAC conventions can be regarded as an algorithmic problem because a set of rules, the notion of fundamental organic functional groups and the specific terminology must be memorized.

A useful approach to help students learn this is to do experimental classes using chemical tests for functional group detection, for example the detection of acid anhydrides, acyl chlorides, esters, ethers, carboxylic acids, etc. Students will be more familiarized with those groups of atoms that compose a chemistry family with similar chemical characteristics.

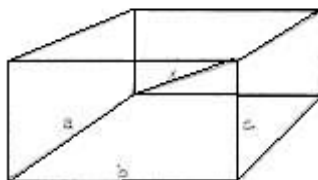
Another approach is to choose a good algorithm to solve nomenclature tasks. Pólya's approach to mathematical problems can be helpful because it is a strategy to reduce the complexity of a problem into smaller and better understandable subunits.

One of the first problems proposed in his book (Pólya, 1945) is to find the diagonal of a rectangular parallelepiped of which the length, the width and the height are known. It is my intention to show the algorithm he proposes to solve the problem: -*What is the unknown?* - *What are the data?* - *What are the conditions?* *Is there a condition linking the data?* - *Can we devise a plan to solve it?* *Where should I start?* - *What can I do?*



**Figure 1** – Rectangular parallelepiped

*What is the unknown?* The length of the diagonal of a parallelepiped. *What are the data?* The length, the width, and the height of the parallelepiped. *Introduce suitable notation. Which letter should denote the unknown?*  $x$ . *Which letters would you choose for the length, the width, and the height?*  $a$ ,  $b$ ,  $c$ . Pólya's following suggestion is to draw a sketch of a rectangular parallelepiped with the elected notification to help to visualize the problem. The solution of this specific problem can be found in his book (Pólya, 1945)



**Figure 2** – A sketch of a rectangular parallelepiped with the chosen notification helps to visualize the problem

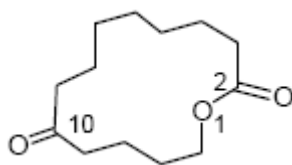
The chemical example I would like to propose is to find structure of the organic compound that corresponds to the IUPAC name of:

6-(4-(dimethylamino)-3-hidroxy-6-methyltetrahydro-2*H*-pyran-2-yloxy)-14-ethyl-7,12,13-trihydroxy-4-(5-hydroxy-4-methoxy-4,6-dimethyltetrahydro-2*H*-pyran-2-yloxy)-3,5,7,9,11,13-hexamethyloxacyclotetradecane-2,10-dione.

*Where should one start?* What is the basic structure? That is, where can the structure that supports all those functional groups be found? In the end as always: oxacyclotetradecane-2,10-dione. *What is the unknown?* What can oxacyclotetradecane-2,10-dione show to us? Nothing, in the case that the few rules that provide the recognition of a macrocyclic ring lactone are not known.

According to IUPAC rules', macrolides, as well as other lactones formed from aliphatic acids, should be named by adding "olide" as a suffix to the name of the hydrocarbon with the same number of carbon atoms. The numbering starts from the ester carbonyl carbon. The IUPAC rules also give an alternative way of naming lactones based on the rules for naming heterocycles. According to this rule the lactones are named as oxacyclo ketones and the numbering starts from the ring oxygen (Kaisalo, 2002).

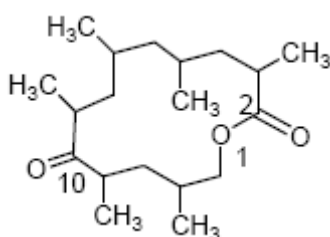
Again: *What is the unknown?* An important part of the unknown is a fourteen membered macrocyclic ring lactone, an intramolecular ester of a hydroxy carboxylic acid.



**Figure 3** – The macrocyclic ring lactone, that can also be described as a macrolide.

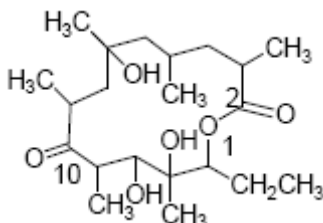
*What are the data? Can we devise a plan?*

The problem gives many data and the plan can be devised by starting to recognize simple functional groups attached to the macrolide. The second step should be to recognize the most complicated ones. The small prefix like hexamethyl means that there are six methyl groups attached to carbons 3,5,7,9,11,13. Drawing the structure there will be the “sub-unit” compound problem represented on figure 4.



**Figure 4** – 3,5,7,9,11,13-hexamethyloxacyclotetradecane-2,10-dione.

There is another simple functional group on carbons 7,12,13; the hydroxyl group. In addition, the ethyl group on carbon 14 is also rapidly recognizable. The resulting compound is represented on figure 5 (not taking into account the special orientation).

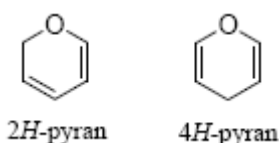


**Figure 5** – A sketch of the structure as devised so far

Going on to the second part of the plan and trying to escalate information, this time underlining the carbons of the macrolide and the main structures their present:

6-(4-(dimethylamino)-3-hidroxy-6-methyltetrahydro-2*H*-pyran-2-yloxy)-14-ethyl-7,12,13-trihydroxy-4-(5-hydroxy-4-methoxy-4,6-dimethyltetrahydro-2*H*-pyran-2-yloxy)-3,5,7,9,11,13-hexamethyloxacyclotetradecane-2,10-dione.

*Why to choose tetrahydro-2H-pyran?* The first clue was given by its position; it is in the end of the sequence. The other clue is more than just an intuition. One needs to know what a tetrahydro-2*H*-pyran ring is. There are two isomers of the pyran ring, both drawn in figure 6.

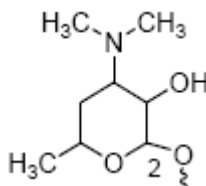


**Figure 6** – The two isomers of the pyran ring.



To be a tetrahydro-2*H*-pyran it means that the two double bonds between the four carbons are hydrogenated. The suffix 2-yloxy means that the tetrahydro-2*H*-pyran ring is attached to the macrolide by an oxygen present on its carbon number 2. Now let us take a close look at the remaining data. Starting from the one that is attached to carbon 6, simply because it is the first to appear in the name, the data that can be collected are:

(4-(dimethylamino)-3-hydroxy-6-methyltetrahydro-2*H*-pyran-2-yloxy). Figure 7 shows the resulting structure of the substituent.

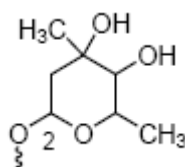


**Figure 7** – Tetrahydro-2*H*-pyran ring attached to carbon 6 of the macrocyclic ring lactone.

*What about the tetrahydro-2*H*-pyran ring attached to carbon 4? What are the data?*

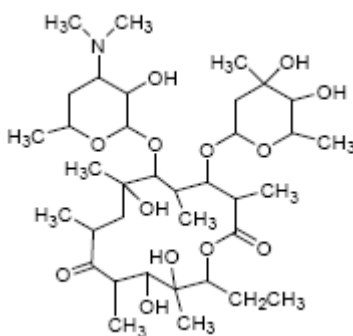
5-hydroxy-4-methoxy-4,6-dimethyltetrahydro-2*H*-pyran-2-yloxy.

On figure 8 it can be seen the resultant structure of the issued substituent.



**Figure 8** – Tetrahydro-2*H*-pyran ring attached to carbon 4 of the macrocyclic ring lactone

The final arrangement of atoms is the structure of Eritromycin, an antibiotic produced by some species of *Streptomyces*, depicted on figure 9 (it was never taken into account the spatial orientations of bonds).

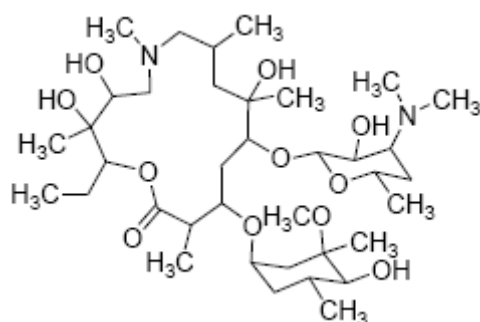


**Figure 9** – Structure of the resulting

Is the solution a plausible one? To know this it is a good strategy to name according to IUPAC's conventions compound of figure 9. The IUPAC's name for the compound of figure 9 is:

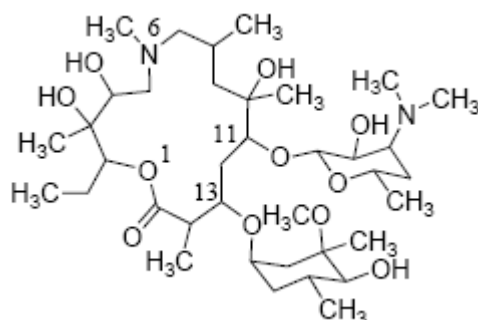
6-(4-(dimethylamino)-3-hydroxy-6-methyltetrahydro-2*H*-pyran-2-yloxy)-14-ethyl-7,12,13-trihydroxy-4-(5-hydroxy-4-methoxy-4,6-dimethyltetrahydro-2*H*-pyran-2-yloxy)-3,5,7,9,11,13-hexamethyloxacyclotetradecane-2,10-dione.

The answer given previously is correct. A similar problem is to give the IUPAC organic name to the similar compound on figure 10:



**Figure 10** – Unknown compound

*Where should one start? What is the basic unknown structure?* It is easy to see that the basic structure is similar to the previous one but that there is an endocyclic nitrogen atom. This macrolides are numbered starting from the endocyclic oxygen of the lactone and in order to give the smallest number to the nitrogen.



**Figure 11** – Numbering of the endocyclic oxygen and nitrogen atoms

The name of the macrolide is skeleton is 1-oxa-6-azaciclopentadecan-15-ona. After numbering these atoms, data can be collected in smaller amounts, and a plan can be devised. Simpler groups can be recognized on the macrolide structure like three hydroxyl on carbons 3, 4 and 10 and seven methyl groups on carbons 3,5,6,8,10,12,14 and also an ethyl group on carbon 2. So we have the following data:

2-etil-

-3,4,10-trihidroxi

-3,5,6,8,10,12,14-heptametil

Looking at carbons 11 and 13, a tetrahydro-2*H*-piran structure can be devised both attached to the macrolide by an oxygen atom attached to carbon number 2 of the tetrahydro-2*H*-piran structure. That information can be extracted from this subunit “tetrahydro-2*H*-piran-2-iloxi”. The most difficult part is done. Know it is easy to identify the small groups attached to these secondary rings and being the complete name of the organic compound presented on figure 10:

11-(4-(dimetilamino)-3-hidroxi-6-metil-tetrahydro-2*H*-piran-2-iloxi)-2-etil-3,4,10-trihidroxi-13-(5-hidroxi-4-metoksi-4,6-dimetil-tetrahydro-2*H*-piran-2-iloxi)-3,5,6,8,10,12,14-heptametil-1-oxa-6-azaciclopentadecan-15-ona

## Conclusion

Pólya's model can be useful because the kind of intellectual approach to same type of mathematical problems present relevant similarities to naming organic compounds using IUPAC conventions. As well as same fundamental knowledge of IUPAC conventions to name organic compounds the skeleton of the algorithm proposed must be fleshed to be turned into win-win strategy.

## References

- M. Cracolice, J. Deming, B. Ehlert, *Journal of Chemical Education*, 2008, Vol. 85, N° 6, June, p. 873-878.
- A. Johnstone, Macro - and Micro - Chemistry. *School Science Review*, 1982, 64, 377 - 379.
- A. Johnstone, The development of Chemistry teaching. *Journal of Chemical Education*, 1993 70 (9), 701-705.
- Pólya G., *How to solve it - A new aspect of mathematical method*, 1945, Princeton University Press.
- Kaisalo L., *Studies on Synthesis and Conformationally Controlled Reactions of Simple 12–15-Membered Macrolides*, 2002, *Academic Dissertation*, University of Helsinki Faculty of Science, Helsinki.

## Dismissing the mole concept

Alfredo TIFI

ITT Divini San Severino Marche, ITALY

Email: a.tifi@divini.org; mob. +39 338-6324518; fax: +39 0733 1990172

### Abstract

*As other abstract chemical concepts, the mole concept should be taught stepwise, following the development of conceptual thinking. On the contrary this concept is always taught as an all-or-nothing-concept, and detached from its actual application in basic stoichiometric calculations. The same holds true for textbooks. A provisional concept, Relative Number of Particles, will be proposed to consolidate the elementary idea of numerical amount associated to chemical quantities, first of completing mole concept.*

**Keywords:** Mole concept, scientific concept, spontaneous concepts, relative number of units

### Introduction

Donaldson [1] describes *disembedded thinking* as “thought that has been prised out of the old primitive matrix within which originally all our thinking is contained.” This kind of thinking requires abstract relations and “far” generalization from concrete experience.

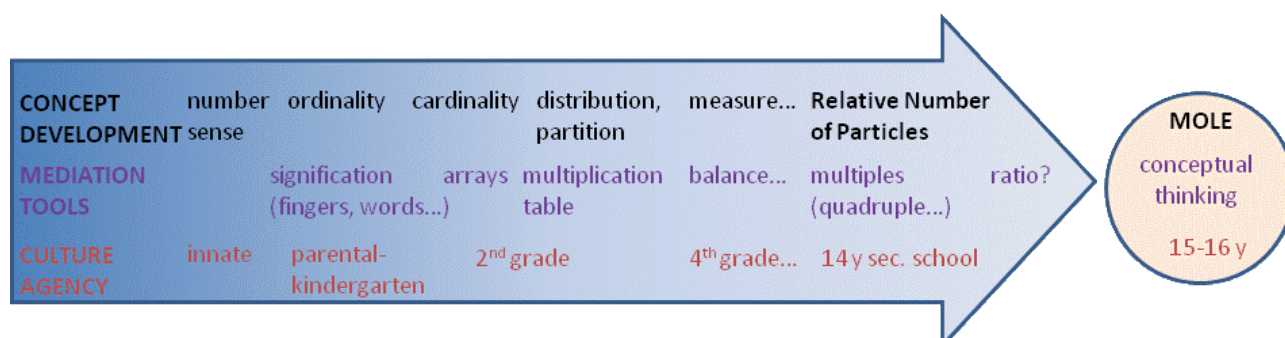
Disembedded thought is rightly judged as the most powerful and desirable educative aim by modern society, but when it is forced by textbooks and premature teaching of abstract concepts it yields only rote memorization and disaffected students.

It exists a developmental age, the adolescent – post-adolescent age, in which complex scientific concepts, that are bound in a system of meanings, can't be taught in the definitive form through top-down processes. The mole concept is one of these concepts which needs a stepped development, starting from the spontaneous-living, contextualized and intuitive matrix. This sort of step splitting of concepts give rise to a spiral curriculum, as suggested by Prof. Barke [2], for example, to follow the bottom-up process of development of atom and ion concepts as “basic particles of matter ... without using the nucleus-shell model of the atom”. A good confidence with macroscopic phenomena and properties, and then sub-microscopic interpretations of these, is necessary first of moving to the formal (disembedded) representational level.

In the case of mole concept (including its application to stoichiometric calculations) we believe that a first stop of the development line could be in the firm appreciation of this measure as a numerical amount of units (atoms, ions, formulas), first of mastering connections to other related concepts (atomic mass unit, molar mass, Avogadro's constant etc.). Provided this simplified form of mole concept is an intuitive concept, we preferred to label it as *relative number of units* or *relative number of particles*, using familiar words. Only after the whole group of students will be able to master calculations at this conceptual level, a complete system of concepts and the mole will be faced *if needed*.

### From counting candies to the mole concept

Simple counting is socially learned from parental education and/or kindergarten, and that experience mysteriously changes the meaning of *counting* from a seriation into a way of evaluating the cardinality (size) of an ensemble of things, by exploiting a sequence of ordinal numbers. The innate-spontaneous sense of number (Figure 1) is raised to the culturally shared concept of cardinal number (top-down).



**Figure 1** Approximate timeline of concept development of some elementary concepts related to the evaluation of object sets' numerical size. Use of scaffolding, or mediation tools, which tend to become more and more abstract and to be embodied in subsequent concepts, is also exemplified.

Not every people comes in his life to consciously consider the conceptual difference between ordinal and cardinal numbers, although everybody correctly *uses* this difference in everyday life language and *can transmit* the implicit concept and meaning of cardinal number to children.

This is just a concrete example to demonstrate that spontaneous-everyday concepts are different in awareness from scientific concepts, and that both should be seriously considered in teaching, having in mind Vygotsky's pedagogical legacy.

Children build up spontaneous concepts as "the number of candies in each bag", "number of bags" and "total number of candies" neither by logics nor by arithmetic, but as the result of immersion in the implicit social rules of a sort of language game, involving some mediation tool as *arrays* (Figure 1). The same bottom-up processes holds true for the subsequent learning of the multiplication table.

All that seems to be "logical" makes its first appearance as product of pieces of socially validated utterances, experiences and sensory-motor imagery. This principle holds also for the first years of secondary school, until around 16-year agers, when increased awareness and control permit first self-stimulated bottom-up and top-down processes. At this stage concepts begin to be isolated and used intentionally as tools in *autonomous reflection*. Complex systems of academic concepts can be taught, remembering that a previous basis of spontaneous concepts and concepts implicitly used as tools must have been created beforehand, because the best top-down "fishing" processes can't yield a lot if there are not fishes in the pond.

This is the sense in which we want to prepare the spontaneous machinery to calculate numerical amounts of atoms or other units at the atomic level, without (or before) introducing the mole concept. Therefore we continue to review the development of numerical amounts and quantities of familiar objects compared with sub-micro entities.

Atoms can't be counted as apples, so their numerical amount could be only evaluated as could be made by calculating the number of candy's bags. In primary school this is a skill that is acquired in the second grade that implies the operation of grouping. But the situation is more complicated by the weight or mass, that is faced in the fourth grade of primary school. With candies the child have to manage just three numerical sets: the whole number of candies, the number of candy's bags and the number of candies in one bag.

With masses (of apples, candies or atoms) the number of sets is doubled, because you have a natural number of objects and an abstract variable, weight or mass, expressing the massive amount of each object's set and of the single object. Yet the operation at the basis of calculation related to total mass is not simple grouping anymore, but is a concrete operation of measuring (weighing) that yields only indirectly the number of apples. This operation will be slowly conceptualized in the forthcoming development as ratio between dimensioned quantities. It is in this complicated context that the calculation of numerical amounts of units should be understood by fourteen-fifteen years aged students. The mole system has a *triple* number of sets: the total amount of substance has a mass, has a total number of atoms, has a number of moles each of which have a mass and a number of atoms, where each atom has its own mass in a diffe-

rent unit from grams (a.m.u.) and also in grams. So calculations with moles are often required to students without the mastery of the relations among all these amounts, without a real grasp of the multitudes of particles which the sub-microscopic level deals with, and without the support of a firmly rooted concept of ratio.

The proposal of calculating the *relative number of units* by dividing the mass of substance by the relative mass of its units, reduces the complexity to the fourth grade of primary school, with four concepts and three variables: total mass, total number of units (unexpressed), relative mass of a unit, relative number of units, in the perspective of making the most fundamental stoichiometric calculation, that is to determinate the mass of substance B that is related to a certain mass of substance A.

Incidentally, we should admit that mole concept has not many more functions other than to facilitate this calculation, whereas it is of primary importance to understand that in chemistry there are integer numbers of atoms that combine instead of continuous amounts of ingredients that are mingled in grams as in making cakes. The relative amount of units can be invoked for the same stoichiometric calculations and has the same numerical value of moles, but is really as easy to calculate as the number of apples in a certain mass.

### Application examples – follow up

After the understanding of atom structure and the concept of isotope it is very important to talk of the relative mass of element's atoms, as results from the weighed average of isotopes atomic weights. Students see that these non-integer numbers can be easily picked up from the periodic table of the elements.

Next step is evaluating and verbalizing multiple and ratio relations between atoms: a helium atom is *four times bigger* (quadruple) than a hydrogen atom, that has the lightest atoms, whereas a carbon atom is around 3 times heavier than a helium atom. Why aren't there intermediate elements between atomic masses 1 and 4? and so on. This is to make confidence with candies in the candy store.

Next question is more or less "are there more atoms in 12,0 grams of carbon or in 12,0 grams of helium?" Although students will answer without calculating, you can introduce the fundamental calculation: "how many atoms of carbon are there in 12,0 grams of this substance?" Most students propose the division  $12\text{g} : 12$  that yields 1. You say simply that this is logically correct, and soon "How many helium atoms in 12,0 g of helium?"  $12\text{ g} : 4 = 3$ . Also this is logically correct, and confirms that there are *three times* more lighter helium atoms than carbon atoms in 12 grams, but "*what can you say about one carbon atom in 12 grams?*" Does that mean that you can see, handle and play with a single atom?"

This is an important point. After the choral negative answer, you can guarantee that - provided the division was made by the relative atomic weight of carbon - the result is *not* the true number of atoms, but just the *relative* number of atom, a number that you can consider as proportional to the "fantastictrillions" of true atoms number, a number that is rarely of interest in chemical calculations. This clarification was due before of talking of application of this numerical amount.

Relative atomic weights can be summed, so to each formula it corresponds a formula weight.

Water and NaCl relative formula weights are 18,0 and 58,5, so 180 grams of water and 585 grams of NaCl contains the same relative number of "formulas", atoms of oxygen, sodium and chlorine, that is 10.

From these basis it's easy to pass to the fundamental stoichiometric calculation: mass of A to mass of B without using moles, proportions, factor-labels or other automatisms.

### Conclusions

This is an example of scaffolding that is made thinking to the future development, if is not aimed to arise immediate mastery of mole related concepts. In the words of Vygotsky [3]:

*"Scientific/academic concepts can arise in the child's head only on the foundation provided by the lower and more elementary forms of generalization which previously existed."*

It is important, anyway, to *prepare* the imitable "pre-concepts" in such a way that they won't obstacle the future conscious processes of subsumption that would be easier since sixteen. The time saved to unsuc-

cessfully pretending to get the perfect all-or-nothing mastering of mole concept in the whole class can be used to make chemistry more exciting and to reinforce the relationship between microscopic and phenomenological-symbolic levels.

It's worth to report the resolution adopted by the 24<sup>th</sup> CGPM reunion held in Paris in October 2011 [4], that proposes to redefine the mole so that it is linked to an *exact* numerical value of the Avogadro's constant ( $6.02214 \cdot 10^{23} \text{ mol}^{-1}$ ). If this definition would be accepted by IUPAC, the concept of mole would become independent from mass and a.m.u. definitions and its complexity would be significantly reduced.

### Reference list

- [1] M. Donaldson, *Children's Minds*, Biddles Ltd., Guilford, Great Britain, 1978, p.76
- [2] H-D. Barke, G. Harsh, S. Schmid, *Essentials of Chemical Education* Springer-Verlag, Berlin-Heidelberg 2012, p. 81, 202
- [3] L. S. Vygotsky, *The Collected Works of L. S. Vygotsky, Vol I. Problems of general psychology*, R. W. Rieber and A. S. Carton (Eds.). New York: Intern. Publishers, 1987, p. 177
- [4] *Resolutions adopted by the General Conference on Weights and Measures (24<sup>th</sup> meeting)* Paris, 17-21 October 2011, [www.bipm.org/utis/common/pdf/24\\_CGPM\\_Resolutions.pdf](http://www.bipm.org/utis/common/pdf/24_CGPM_Resolutions.pdf), Accessed 07 August 2012

## Beginners approach to chemistry in a “MILD” inquiry based learning laboratory context

Alfredo TIFI

ITT Divini San Severino Marche, ITALY

Email: a.tifi@divini.org; mob. +39 338-6324518; fax: +39 0733 1990172

### Abstract

*The halving of laboratory time in the first two grades of secondary school in Italy has compelled some sensible teachers to redesign the role of this instructional resource in the curriculum and the teaching methodology in class & lab, viewed as a continuum. The aim of this report is to demonstrate that the redesign in scope and perspectives in the use of laboratory can be integrated to a general renewal of curriculum and methodology based on Vygotsky's sociocultural theory, targeted to 14-15-years-old students, may afford to better inquiry learning and outcomes.*

### Keywords

Inquiry Based Learning, flexible curriculum, mild Inquiry Based Science Education,

### Introduction

The recent halving of laboratory time in the secondary State Technical Institutes in Italy has – *only apparently* - impaired the possibility to exploit this resource in basic chemical education. Anyway, after two years of “accommodation” to this new timing, we have been compelled to re-think some aspects of laboratory as a resource, and some conditions for its effectiveness that, because of the “abundance” of this resource, have been overlooked in the past.

Based on the characteristics of 14-years-old learners and on preliminary experimental trials, we want critically set the basis for implementing an effective *mild* IBSE (Inquiry based science education) curriculum [1], according to the philosophy of the PROFILES (Professional Reflection-Oriented Focus on Inquiry-based Learning and Education through Science) project that claims for CPD (continuous professional development) and for the search for ways of bearing motivation in the *formal* teaching/learning of Chemistry [2].

### Setting the pedagogical problem first

There is a wide gap between practiced teaching and advices coming from education literature. The most diffused praxis sees teachers devoted to provide instructions for writing meaningless transformations and formalisms rather than producing learning. The best promising pedagogies and philosophies – which in our opinion are the ones based on inquiry learning [1, 3] and on Student-Focused-Active-Learning [4] - agree on what is going wrong on custom and tradition-based learning, but are less effective to address how to adapt ideal sets of rules to real classes and real students. Theoretical models seem often very far from being helpful in class teaching and, most of all, they are too much generalizing, mindless of students' age and of their high degree of heterogeneity in thinking skills. Most of Inquiry Based projects are really adequate for well selected >16 years-old students. *Learning teams* formed by 14-15 years old students, in our experience in normal classes at “technical secondary school”, remain often silently stuck when they are asked to face simple socially shared tasks, as formulating a text phrase to describe data or observed phenomena evidences. Students' previous experience of “reproductive” instruction is perhaps one main cause of this inaction, making them waiting for some “dictation” or item list where to choose the answer from, searching for “the expected-correct answer” to copy from any printed page or board around them, uncritically. Processes as thinking, simple trial and errors, questioning and identification of flaws in understanding, are banned from the aptitudes of these students because of their previous expe-



rience that excluded these functions (neither of which served in the school of “direct transmission of knowledge”), but also because of the incapacity for conceptual thinking, for the reduced language skills or both, for so many of them. Independently from negative students’ educational heritage, *it is simply too much early for asking them reflection, reasoning and metacognition, whereas the setting of these cognitive skills is not a premise but the main objective of the two-year scientific education.*

We should be aware that we start with students “explaining phenomena in a concrete-pictorial and in a magic-animistic way of speaking” [5], not primarily because they lack knowledge, but because they are unable to distinguish representations from objects and to isolate concepts from their own narratives about phenomena (often implicit), because their *structures of generalization* are not of the type that serves to go up and down from spontaneous concepts to scientific ones and vice versa, because their internal meanings are holistic, created from the whole impact with experience, and cannot be analyzed in separate semantic parts, while the external speech reflects the inability of inner speech to go from short phrases to connected-complex propositions, as was perfectly described by Lev Vygotsky [6] for the adolescent stage of development of the thinking/speaking system, and recently reviewed by Holbrook Mahn [7]. There is one important and practical distinction between the comfortable (but static) depiction based on Piaget’s period of concrete operations [5] and Vygotsky’s interpretation of development as progressive differentiation of meaning from language that gives rise to the possible shift from complexes-structure to conceptual-structure of generalization. The distinction is in that the socio-cultural-theory of the latter *explains* how to promote the step towards formal operations, as a result of continuing the same kind of scaffolding that led up to concrete operations, gained from formal education and *both* informal-social interactions, while the former keeps separate language development from thinking development, with sociocultural environment acting only as an agent of reduction of “egocentrism”, thus permitting the next (echo-biological) “maturation” to the formal-operations stage [8]. Education shouldn’t be “neutral” respect to this “maturation”, that is intrinsically sociocultural, so Vygotsky’s theory is preferable for it expressly addresses the way: by helping students within their zone of proximal development, we offer them useful learning strategies which they internalize and will utilize later. This is a crucial point: if we don’t address 14-years-age students to these “forward-looking” activities, we run the risk to find 16-17-years-old students *unchanged*, as we often find and complain for. As preliminarily attempted in beginner’s classes, POGIL (Process Oriented Guided Inquiry Learning) and similar Inquiry Based Learning [4] strategies are not at all applicable to these students because their thinking-in-concepts has not started yet. Vygotsky perspective implies that the teacher is a very active member, close connoisseur and observer of her student's processes, by providing assistance and offering feedback when relating new information [8, 10]. Teachers should also make sure that students are provided adequate cultural tools for learning, and the role and times of cooperative-learning team work - albeit relevant and necessary - should be more balanced with the direct mediation experience by teacher-regulated socratic discussion with both groups and whole class. But there is an important and overlooked difference between earlier and later cultural mediation: the scaffolding tools and signs that were used in primary school instruction (e.g. finger counting, grammar rules, mnemonic, algebraic algorithms, concept labels, etc.) worked well to anticipate the internalization process (i.e. the slow enabling of the learner to use the same tool for others with the same meaning as it was used by adults to convey a tacit meaning to her [9], after repeated and reciprocal use of the mediation tool) *even if the instructor or the caretakers were completely unaware of the implicit meanings and generalizations that they were to convey, and of the differences between their tacit concept and learner’s pre-concept at the beginning of the process.* When the mediating tools are abstract processes or scientific concepts (tools or signs to connect abstract-meaning domains), the instructor cannot be anymore unaware of what’s going on in herself inner meaning system, in the academic level of signification, and about the expected change in the student’s thinking/speaking system of meanings. *So it is out of discussion that adolescents need direct-expert cultural mediation and that learning teams formed by peers won’t ever do the task by themselves.*

There are many examples in chemical education to apply these principles. Let’s pick up the chemical-equation-balancing tool. There are lots of evidences that students successfully and repeatedly balance

equations (and often relate their “chemical self-esteem” to this ability) without any improvement of their understanding of what’s going on in the test tube and with its substances, atoms, molecules and ions, and of the very meaning of coefficients. The “balancer-teacher” should be honest and admit that that competence does not add anything to these students’ understandings if he or she is not consciously aware of the meaning and specific purposes and experimental contexts of balancing, and does not try to convey the same awareness for the same reasons and contexts to them, instead of making them skilled and satisfied as “purposeless balancers”. A few occasions of *simple* balancing should be made *only to pave the way to meaningful pre-concepts of the limiting reagent and incomplete conversion concepts*, keeping the eye on the real chemical system from the macroscopic and submicroscopic point of views, and not as a formal manipulation for itself as it is pleaded with Lavoisier law. The stake is higher than understanding of mass conservation.

Specificity of application of ZPD Vygotsky’s theory to the first grade 14-15-years-old learners can be synthesized saying that teacher’s awareness is of *conceptual type* and *should include knowledge of typical misconceptions*, whereas for former (primary) education mediator, procedural or task-skill oriented awareness is sufficient. This can be justified recognizing that scientific-concept-based cultural tools are different in abstraction from procedural tools. Teaching at the level of procedure-skill-based tools at this developmental age wouldn’t be successful to make the desired shift to conceptual thinking. So the mediation tools adequate for 14-15-years-old learners must be those that are closer to explicit meanings, such as narrative phrasing structures, oral *and* written. Although models (pictographic, iconic, symbolic, etc.) and objects (candies, nuts & bolts etc.) can be important, they can be manipulated without relations to the real chemical concepts-objects, thus their usefulness is eventually depending by the verbalized and shared meanings.

### **Criteria for mild inquiry based learning activities**

If we want that laboratory and class activities will be empowering as a source of development, in the sense “that the only ‘good learning’ is that which is in advance of development” [9], each activity should clearly distinguish which premises, ideas and facts will be “given”, which part will be both the object of *supported inquiry & gained awareness*, and which important scientific concepts will be targeted by these repeated *assisted awareness experiences* (Table 1). To understand what is meant by “assisted awareness” we have to go back again to Vygotsky’s thought: “Consciousness and control appear only at a late stage in the development of a function, after it has been used and practiced unconsciously and spontaneously...” [9]. Thus instructor’s scaffolding becomes necessary as a “loan of consciousness” in the sense described by Bruner [10]. This makes clear that the system of scientific concepts, as well as mastery of isolate scientific concepts, represent only future objectives, outlined in the instructor mind, and that the job described till now has the function of *preparing* what is needed in future development, since: “...In order to subject a function to intellectual control, we must first possess it” [9]. Professor Barke [11], in describing students’ wrong interpretations of magnesium combustion and of combustion as destruction, illustrates how this progression is very different from traditional teaching: “This example shows that students learn the equation only formally, but keep their mental model from everyday life that they developed in 10-15 years of observations. Teachers should know that they cannot effect complete conceptual change from students’ in 1 or 2 h of instruction: for several weeks one has to show new experiments concerning combustion...Nearly every student has to undergo a big conceptual change concerning the interpretation of burning coal, candles, or alcohol. The teachers can talk and talk – they will still not convince young students to overcome their destruction theory. The only way to achieve this is by interpreting convincing experiments and structural models”. In agreeing with Barke’s views, we highlight the *interpretation of the experiments and of the models*, as being more important of the number of experiments, more important of resolving *every* cognitive conflict with appropriate counter-convincing experiments (that can be excessively time consuming without warranting easier assimilation of new concepts). Oral and written verbalization, negotiation of words and utterances, in the learning-team or community, correspond to the cultural mediation tools that are suitable for this age of development to

prepare learners to generalized chemical concepts (e.g. chemical reaction and combustion reactions). To achieve definitive scientific concepts at the end of each activity or learning cycle is impossible at this age, in four as well in eight weeks, even if any misconception is removed and falsified with proper and convincing evidences, because voluntary control of concepts (and associated autonomous awareness) is just the hoped product of a *two years business*. Firstly students will prepare the spontaneous basis in the form of speech utterances of growing complexity. In this period every important concept should be addressed stepwise, covering a long range in the curriculum [12]. *Long-term motivation will arise (if negative attitude about school or the subject won't cause an a priori reject of even the intrinsically interesting facts) by establishing a consistency between affection and cognition development, kindling curiosity and interest through natural and laboratory phenomena (short-term motivation) and leading the students from situational interest to inner feeling of self-effectiveness and self generated curiosity* [11]. This should be easier in chemistry than in other sciences, provided the massive number of possible observable phenomena that can be implemented in hands-on experiments, in demonstrations, in individual home experiments, with a component of inquiring that will be prepared beforehand discussed, and elaborated as shared texts, within learning teams and/or the whole learning community. Thanks to Google Apps technology, part of the individual and team elaboration can be committed to the online-after-school shared documentation. All the above description summarizes the experimental methodology that is under development in a class in our institute. Out of the 20 main activities in 90 unity-lessons and 30 weeks of the past school year, documented in 34 Google Sites pages [13], we will describe an example.

### Example activity record: probing gold atoms

This activity that exploited a true remote controlled Rutherford's diffraction machinery [14], was led in four class-periods by 12-19 of March 2012, with the purpose to "discover" the nuclear atom model and understand how hard (but not impossible) is to elaborate new scientific ideas. The following record is taken from the online diary (Italian) [15].

Table 1. Paradigmatic teacher's table

"Given" information	What the inquiry is for	Long term concepts & attitudes
<p>Atoms are neutral but formed by negative charges called electrons and a balancing positive charge.</p> <p>There are experiments demonstrating that electrons are both very small and thousand times lighter than the rest of the atom.</p> <p>The idea of "fullness" of matter and the proven smallness of electrons have favored the Thomson or "water-melon" idea in which the tiny electrons are regularly spaced out inside a homogeneous distribution of positive charge.</p> <p>Alpha particles are randomly emitted by unstable (radioactive) atoms, at very high velocity and energy. Their mass is the same of an helium atom (nearly a fiftieth of a gold atom), and their charge corresponds to two electrons, but positive. Alpha-particles beams are absorbed in blocks of lead but have enough energy to pass through very thin metal foils and to be detected with electronic counters one-by-one.</p>	<p>To determine the real distribution of scattered alpha particles after crossing a true gold foil at varying angles (feasible interval: <math>0 \div \pm 35</math> degrees).</p> <p>To describe the expected scattering pattern for a "water-melon" kind of atom</p> <p>To put forward explanations of the high-angle-scattered alpha particles within the Thomson model and propose different arrangements of the electron and positive charge distribution in the gold atoms (changing atom model).</p>	<p>There exist natural <i>facts</i> standing behind our knowledge, independently from teacher and school content, that can be interesting for students as well.</p> <p>Textbook pictures of sophisticated experimental settings correspond to real low cost machines that also students can put at work and manage.</p> <p>What we know is what we imagine to the sake of interpret or fit experiments and this is very different from having a direct and thorough view of what matter and particles are like.</p> <p>The same experimental evidences can be explained by different models.</p> <p>Atoms are mainly empty structures with a small positive nucleus attracting electrons with strong electrical interactions.</p>

12<sup>nd</sup> March. Students were told that in the first experiments (till 1908) alpha rays plots were detected collectively with photographic plates. It was impossible to detect single alpha particles, and the beam emerging from the gold sheet appeared to impress only the central part of the plate. The result was not different from what one might have found by shooting through a heap of water melons. The experimental outcome changed significantly after a Rutherford's collaborator (Geiger) invented a special fluorescent screen that permitted, in the dark, the observation of flashes produced by single alpha particles. A modern electronic version of this counter has been automated in the apparatus that was shown to the students for web remote control. The students tried the intuitive and easy operations of the experimental apparatus, as changing the gold foil sample with an empty slit, changing detection angle and counting time. Then each student was able to repeat the experiments at home, changing variables and recording his data in a shared Google spreadsheet.

14<sup>th</sup> March. Data was analyzed and further experiments were repeated in the classroom. Only a few alpha particles were deflected at 20 degrees in one-two minutes of counting, with the gold foil inserted, but none hit the detector at the same angle with the empty slit. The first attempt to explain the rare alpha particles at wide angles was made by Nicholas as "due to the thermal gold atoms movement". That hypotheses was really amazing, not only for its unexpectedness (even the teacher was considering a static view of gold atoms), but because it demonstrated that the previous module about observable causes of molecular motion had been assimilated and *spontaneous concepts* were far transferred, at least for one student.

16<sup>th</sup> March. Other measures was taken and Nicholas' hypothesis (after careful teacher's meditation) was regarded as experimentally verifiable by extreme temperature changes of the gold sample, although temperature was not a controllable variable in the available apparatus. Anyway the students were warranted that by comparing the mean kinetic energy of alpha particles travelling at 20000 km/h with gold atoms thermal energy, any significant effect could have been excluded. To rise gold atoms energy so much to cause them hitting and deviating alpha particles, the temperature should be so high that the atoms would evaporate themselves making the gold film to disappear; moreover, similar collisions of alpha-particle upon gold atoms almost in rest -considered as rigid spheres- should cause the expulsion of these atoms and the formation of holes in the gold foil, an eventuality that does not occur. After this counter-arguments, *it was clear to everybody that gold atoms were not rigid spheres*, but they were pierced by alpha particles while the beam were passing through the gold foil. We had to do with remote *facts* regarding an invisible beam of particles, an imaginary atomic level description of the gold foil under development, and a "water melon" model that was given but hardly considered as an interpretation tool. All these were expected to be merged to form a coherent image, but that was possible only thanks to the "lend of consciousness" by the teacher. After a class discussion about the strangeness of alpha particles deflected at high angles and the report of the very rare cases of back bouncing observed by Geiger and Marsden in hours of observation (far more than the 300 seconds permitted by the apparatus), a homework questionnaire was given as a Google form to arise a better understanding and confidence with the "invisible" part of the experiment and to prepare to a possible change of Thomson model. The questions regarded *a)* the possible self-scattering of alpha particles because of their repulsion, *b)* the possible high distance among gold atoms to explain rare deflections, *c)* what would had been the experimental outcome if the atoms had really made as water-melon models, *d)* the supposed dimensions of alpha particles, as compared to the electron and, finally, *e)* what could cause the rare deviations at wide angles, while the alpha particles were passing through the gold atoms.

19<sup>th</sup> March. The few answers to the questionnaire were shared and discussed. Some students invoked collisions with fast moving electrons as the cause of wide deflections; other similar answers denoted that a textbook search "interfered" with the available and shared documents synthesizing the previous agreements. There were evident difficulties to take in account for facts and discussed ideas, so a best focused question was given to the six learning groups during the class: "what in the gold atom does make the few alpha particles deviate at 20 degrees? What should be changed in Thomson model?" A picture of the experimental setting with question-marked atoms [15] was given to help a concrete focusing of the

problem. The discussion was somewhat “oriented” towards a change in the positive charge distribution. In a 20 minute group discussion, the following answers were elaborated.

A. Atoms are composed by a positive nucleus and an empty part. Only the alpha particles that hit the nucleus are deviated, while the others pass through straightly.

B. Positive charge of every atom is concentrated in a point, not dispersed.

C. The most obvious explanation is that the positive charge is compacted and alpha particles deviate only if they collide with this positive charge.

D. We agree that atoms are not filled up of pulp as the water melon, but there must be a certain point where the positive charge is more concentrated and causes alpha particles deviations.

E. The ?-marked gold atoms vibrate and with their vibrations they hit alpha particles that deviate toward the detector.

F. In our opinion the electrons are not scattered, but grouped together, and when the alpha particles run to crash with them, they are deviated.

So the outcome was that four groups by six, opportunely supported, did understand what took two years to Sir Rutherford. This result was good, but maybe the E and F groups conclusions were the best demonstration that the process was going in the “Long term concepts & attitudes” expected direction. The F team was awarded for having invented the alternative “melon model” of the atom, while E team demonstrated (if needed) that convincement, evidences and logics are not only insufficient to change conceptions, but that they can also install in some learner’s mind right the spontaneous imagines and ideas we wanted to remove. Furthermore, besides literature-popular misconceptions, this developmental age sees a greater number of tacit beliefs that are created in class situation and happily coexist in contradiction with taught conceptions. In conclusion, the alternative models were discussed and criticized again and the nuclear model was compared with the textbook chapter and other sources. Every student answered the five-question Google form at home, then as usual the answers were reviewed by the teacher and briefly discussed in the subsequent classes.

## Conclusions

An experiment of methodological and curricular setting started in the previous academic year within one group of 21 students, dealing with around 20 topics, and a few “milestone” experiments (conceptually simple or that can be simplified, with high impact, sources of generalizations, and in which the teacher is very experienced) like Rutherford’s. The reciprocal interplay between the curricular and the laboratory programs, can be only roughly sketched in planning the curriculum, as it will be continuously adapted to the class. This curriculum setting will be continued in the second grade with more discussions, readings, written reports and narratives in learning teams. One hour of laboratory by three in a week was demonstrated to be sufficient by integrating group hands-on experiments, demonstrations and other kinds of “mild” inquiry learning activities, with mind-prepared students, by the integration with curricular activities. Materials were prepared in advance and students never wasted time in queues at the balance. Techniques were never practiced for themselves. Students and learning groups were submitted to more than 30 formative assessments (the sole form of evaluation that helps learning). Everything was thought to develop something more important of subject contents, that are science attitudes, curiosity, awareness, thought control, critical argumentation. Scaffolding was made in view of future development. It was not aimed to arise immediate mastery of content related concepts, sticking to Vygotsky’s advice [16]:

*“Scientific/academic concepts can arise in the child’s head only on the foundation provided by the lower and more elementary forms of generalization which previously existed.”*

## Reference list

- [1] J. N. Spencer, *New Directions in Teaching Chemistry: A Philosophical and Pedagogical Basis*. *J. Chem. Educ.* 1999, 76, 566-569
- [2] C. Bolte, A. Hofstein, J. Holbrook, M. Rannikmae, R. Mamlok Naaman, F. Rauch, S. Streller, PROFILES - Professional Reflection-Oriented Focus on Inquiry-based Learning and Education through Science, paper presented at the ESERA conference, Lyon, France September 2011

- [3] J. J. Farrell; R. S. Moog, and J. N. Spencer, *A Guided Inquiry General Chemistry Course*. *Chem. Educ.* 1999, 76, p. 570-574
- [4] C. R. Landis; E. Jr. Peace; M. A. Scharberg; S. Branz; J. N. Spencer; R. Ricci; S. A. Zumdahl; D. Shaw. *The New Traditions Consortium: Shifting from a Faculty-Centered Paradigm to a Student-Centered Paradigm*, *J. Chem. Educ.* 1998, 75, 741-744
- [5] H.-D. Barke, G. Harsh, S. Schmid, *Essentials of Chemical Education* Springer-Verlag, Berlin-Heidelberg 2012, p. 8
- [6] L. S. Vygotsky, *Thought and Language*, revised Edition by A. Kozulin, Massachusetts Institute of Technology, Baskerville (MA). 1986, p. 219
- [7] Mahn, H. (2012) *Vygotsky's Analysis of Children's Meaning Making Processes*, Downloadable from International Journal of Educational Psychology: Hipatia Press, [www.hipatiapress.info/hpjournals/index.php/ijep/article/view/289](http://www.hipatiapress.info/hpjournals/index.php/ijep/article/view/289) (Accessed 12/08/2012)
- [8] A. Woolfolk. *Educational Psychology* (9th ed). Allyn and Bacon, Boston, 2004
- [9] L. S. Vygotsky, *The Collected Works of L. S. Vygotsky*, Vol 4. *The History of the Development of the Higher Mental Functions*, R. W. Rieber Editor, Plenum Press, New York, 1997 chap. 5, p. 104-107
- [10] J. Bruner, *Actual Minds, Possible Worlds*. Harvard University Press, Cambridge, Massachusetts and London, England, 1988, p. 76
- [11] H.-D. Barke et. Al, *Essentials of Chemical Education*, Springer Verlag, Berlin Heidelberg, 2012 p. 11, 18
- [12] A. Tifi, *Dismissing the Mole Concept*, Submitted to *Chimica nella Scuola* for the proceedings of the 22<sup>nd</sup> International Conference on Chemistry Education, Roma 2012
- [13] ITIS Divini, Classe 1E-2E biennio 2012-13 Chimica, <https://sites.google.com/a/divini.org/classe-1e-chimica/>, accessed 17 August 2012
- [14] Remotely Controlled Laboratories – RCLs: <http://rcl.physik.uni-kl.de/>, accessed 17<sup>th</sup> August 2012
- [15] ITIS Divini, Classe 1E-2E biennio 2012-13 Chimica, <http://sites.google.com/a/divini.org/classe-1e-chimica/home/attivita/12marzo2012lesperimentodirutherford103annidopo>
- [16] L. S. Vygotsky, *The Collected Works of L. S. Vygotsky, Vol I. Problems of general psychology*, R. W. Rieber and A. S. Carton (Eds.). New York: Intern. Publishers, 1987, p. 177

# MEMS Design Tool in Teaching Orientation Dependent Double Sided Silicon Etching

Shailendra Kumar TIWARI<sup>a</sup>, Somashekara BHAT<sup>a</sup>, Krishna K. MAHATO<sup>b</sup>

<sup>a</sup>Dept. of E. C. E. Manipal Institute of Technology Manipal, Manipal, India-576104

<sup>b</sup>Manipal Life Science Centre Manipal, India-576104

E-mail: sk.tiwari@manipal.edu Phone +91-820-2924821; Fax +91-820-2571071

## Abstract

Silicon is the most preferred material in Micro-Electro-Mechanical-System (MEMS) industry due to its mechanical properties and thermal conductivity. A large number of micromachined structures can be realized using double sided wet etching of silicon e.g. membrane of pressure sensors, microfluidic channels, through-holes in wafer etc. Potassium Hydroxide (KOH) and TetraMethylAmmonium Hydroxide (TMAH) are most popular wet anisotropic etchant available in the market. Anisotropic etching of silicon is plane dependent and with the progress of time, etch pattern is also changing. Therefore it is very difficult to understand the concept of etching of silicon by students and at the same time it is also very difficult for an instructor to convey the information effectively using black board teaching which needs a very good drawing skill as well as a lot of time. In this paper an attempt has been made to use IntelliSuite 8.6 computer based MEMS simulation tool to explain the etch process. The tool can capture the etch profile of the structure for different time interval and it also provides the option to make a video file of etching process which can be used for teaching the etching of silicon.

**Keywords** Double sided etching, Intellisuite, mask, misalignment, simulation, wet etching.

## 1. Introduction

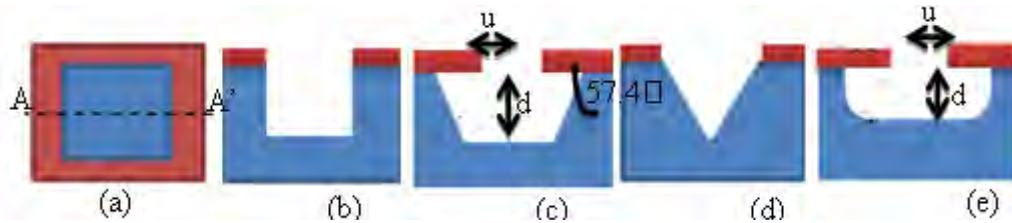
Silicon is one of the most important materials for the semiconductor industry, the oxide of silicon i.e. SiO<sub>2</sub> is very stable and provides a very good surface passivation, this oxide layer is free from contamination and composition is decided by starting wafer [1]. It is easy to grow and has a good interface with the wafer below. The SiO<sub>2</sub> is widely used as a gate oxide in MOSFET, diffusion mask and *etch-mask*. Silicon is one of the most preferred materials in MEMS industry due to its mechanical properties and thermal conductivity. Young's modulus of the silicon is 190 GPa, which is very close to steel (210 GPa) whereas the density of silicon is 2300 kg/m<sup>3</sup> which is very less compared to steel (7900 kg/m<sup>3</sup>) therefore silicon is much lighter compared to steel [1,3].

In MEMS industry many micromachined structures are realized using Bulk micromachining. Bulk micromachining is a technique in which structures are realized by etching the silicon substrate. Membrane of a pressure sensor, microfluidic channels, through-holes in the wafer are the few examples for Bulk micromachining. Etching can be performed in dry mode or in wet mode. In dry etching the silicon is etched with the help of high energy plasma; whereas wet etching is performed with the chemicals like KOH, TMAH and HNA (isotropic etchant).

Figure 1 shows the cross-sectional view of etch profile of isotropic etching and anisotropic etching. Figure 1(a) shows top view of silicon surface (■) with a SiO<sub>2</sub> layer (■), Fig. 1(b) shows the etch pattern of 100% anisotropic etching carried out by deep reactive ion etching with zero lateral and non-zero vertical etch rate. Fig. 1(c) shows the etch profile of anisotropic etching with non-zero lateral and vertical etch rate, in this case (111) plane has non-zero etch rate and the rate, in this case (111) plane has non-zero

etch rate and the undercut  $u$  is given by 
$$u = \frac{r_{\langle 111 \rangle} T}{\sin(54.7^\circ)} [6]$$

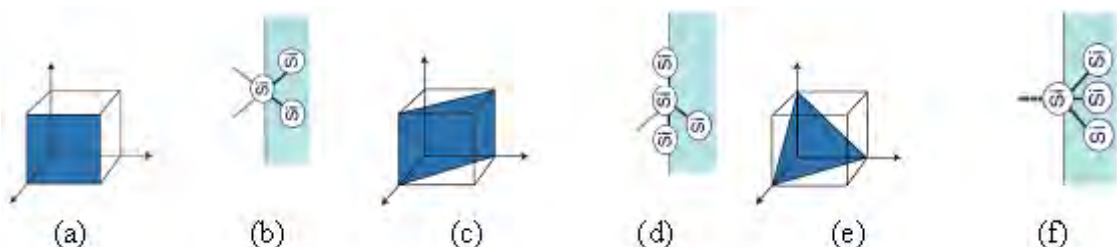
Where  $r_{\langle 111 \rangle}$  is etch rate of (111) plane  $T$  is the etch time. Fig.1 (d) shows the etch profile of anisotropic etching with negligible (111) etch rate. In this case etching stops when all the (111) planes meet at a point. Figure 1(e) shows the isotropic etch profile, in this case etch rate is same in both vertical and lateral direction.



**Figure 1** Silicon etching using a square shaped  $\text{SiO}_2$  mask (a) Top view of square shape  $\text{SiO}_2$  patterned silicon substrate. (b) Cross-section along A-A' of the etch profile of anisotropic etching for etchant with zero lateral and non-zero vertical etch rate ( $\rightarrow$  undercut  $u=0$ ). (c) Cross-section along A-A' of the etch profile of anisotropic etching for etchant with non-zero lateral and vertical etch rate, but lateral etch rate  $\neq$  vertical etch rate ( $\rightarrow$  undercut ' $u$ '  $\neq$  etch depth ' $d$ '). (d) Cross section along A-A' of the etch profile of anisotropic etching of silicon with no undercut. Etching stops when all (111) planes meet. (e) Cross section along A-A' of the etch profile of isotropic etching of silicon substrate.

## 2. Double Sided Bulk Silicon Etching

In the MEMS industry KOH is the most frequently used anisotropic etchant solution. When we perform etching using KOH,  $\text{SiO}_2$  is commonly used as etch mask. Etch rate selectivity of Si over  $\text{SiO}_2$  is of the order of 150:1[3]. Thus for long etching of silicon it is possible that  $\text{SiO}_2$  gets etched away. One possible solution is to have a thick oxide layer. But maximum thickness of the oxide layer is decided by the oxidation time. It can be easily shown that; practically it is not possible to grow oxide layers of thickness more than  $2\mu\text{m}$ . If we have silicon wafer of  $300\mu\text{m}$  thickness, and if it is required to etch a through-hole through the wafer using KOH with a etch rate of  $85\mu\text{m}/\text{hour}$ , it will take 3.52hrs. More than this we need an oxide layer of  $2\mu\text{m}$ . Thus total etch time is the oxidation time for  $2\mu\text{m}$  oxide (8hrs 15 min wet oxidation at  $1100^\circ\text{C}$ ) followed by 3.52hrs of actual etch time. Thus it is going to be unacceptably a large time. One possible solution is to perform double side etching so that we can reduce etch time into half and reduce the demand on oxide thickness. However this has its own inherent issues related with it. It becomes essential to align the masks on the two sides of the wafer; which needs special lithography machine. For a student it is important to understand the effects of misalignment in the mask on the final etch profile. It is difficult to draw and teach these etch profiles on a black board. This approach is both time consuming and ineffective in teaching the same. Using series of simulation videos, this paper explains the process of double side etching, effects of mask misalignment on the final etch pattern.



**Figure 2** Crystal planes of silicon indicated by Miller Index [3] (a) (100) plane (b) Si atom present at the surface of (100) plane and two dangling bonds (c) (110) plane (d) Si atom present at the surface of (110) plane, surface bonds and the a dangling bond (e) (111) plane (f) Si atom present at the surface of (111) plane and a dangling bond.



Figure 2 compares three different surfaces cut from the same crystal. They are indicated by using the Miller index as (100), (110), and (111), respectively. When an atom is located on a surface, the bond belonging to the atom loses a neighboring atom. It is known as a dangling bond. The dangling bonds easily react with the etching agent [3]. When the number of dangling bonds on three differently oriented surfaces, (100), (110), and (111), are compared, it is observed that the (111) surface has the only one dangling bond per surface atom, whereas there are two dangling bonds for (100), and one dangling bond plus two surface bonds for (110). This is the reason why (111) plane is difficult to etch. The etch profile is decided by the angle between (100), (110) and (111) planes [3] because of different etch rates in different planes of silicon.

**Table 1:** Angle between Si planes

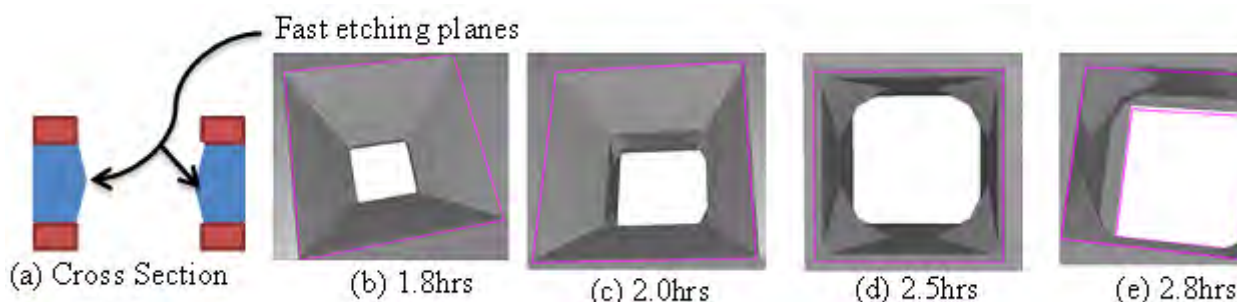
Plane 1	Plane 2	Angle (Degrees)
(100)	(110)	45.00
(100)	(111)	54.73
(110)	(111)	35.26

**Table 2:** Separation Si planes

Plane	Separation (d) Å
(100)	5.43
(110)	3.84
(111)	3.13

Table 1 shows the angle between different planes [1]. Table 2 shows separation between the planes of silicon and it is seen that the separation between two (111) plane is  $3.13\text{\AA}$  which is minimum with respect to other planes [1,3]. If an etchant solution etches (111) plane immediately it finds another (111) this is also one of the reason why (111) plane is difficult to etch by the KOH or TMAH.

To get a proper through-hole using double side etching; mask alignment is most important step. The possible mask misalignments are X-misalignment (row 2 of Table 3), Y-misalignment (row 3 of Table 3), XY-misalignment (row 4 of Table 3) and theta misalignment (row 5 of Table 3). If the etch time  $T$  is less than  $0.5t/\langle r_{100} \rangle$  then it will result in membrane which is realized in half the time compared to the single sided etching process. If the etch time  $T$  is greater than  $0.5t/\langle r_{100} \rangle$ ; as the fast etching planes are exposed at the corners (Fig. 3(a)), etching will continue to take place at these corners. The resulting profiles at various time intervals are shown in Fig. 3(b) to (e). If we continue to etch for an indefinite time, the whole wafer will be etched.



**Figure 3** Etch profile for  $T$  is greater than  $0.5t/\langle r_{100} \rangle$

### 3. Conclusion

An instructor discussing the double sided etching process of single crystal silicon needs a good drawing skill. With the traditional teaching method it would take 2-3 hours in drawing and teaching the patterns. This paper we have explained how simulation tool like Intellisuite can be effectively used in assisting the teacher in teaching the etch process.

Table 3: Etch profile with possible misalignments in top and bottom mask

Etch Time	Top and Bottom mask	Cross-sectional view	Important dimensions	Simulation result
$T = 0.5t \leq t_{100} \leq 1.76t$			$w \geq \frac{2t}{\tan(54.7)}$ $w' = w - 0.71t$ $t = \text{wafer thickness}$	
			$w \geq \frac{2t}{\tan(54.7)}$ $w' = w - 0.71t - 2\Delta x$	
			$w \geq \frac{2t}{\tan(54.7)}$ $w' = w - 0.71t$	
			$w \geq \frac{2t}{\tan(54.7)}$ $w' = w - 0.71t - 2\Delta x$	
			$w \geq \frac{2t}{\tan(54.7)}$ $w' = w - 0.71t - 2\Delta x$	
Following data are used for the simulation.				
Etch rate ratio of the planes 100:110:111= 85:127.5:0.98 $\mu\text{m}/\text{hr}$ , Wafer thickness $t = 300\mu\text{m}$ , Window size $400\mu\text{m} \times 400\mu\text{m}$ and x and y misalignment $\Delta x = \Delta y = 20\mu\text{m}$				

#### 4. References

1. S. K. Gandhi, VLSI fabrication Principles Silicon and Gallium Arsenide, Wiley, 1994
2. Robert Boylestad, Louis Nashelsky, Electronic Devices and Circuit Theory, Prentice Hall, 2004
3. Yogesh B. Gianchandani, Osamu Tabata, Hans Zappe, Comprehensive Microsystems, Elsevier, 2008
4. James M. Bustillo, Proceedings of the IEEE, Vol. 86, No. 8, August 1998
5. Gregory T. A. Kovacs, Proceedings of the IEEE, Vol. 86, No. 8, August 1998
6. Chang Liu, Foundations of MEMS, Prentice Hall, 2011

## Teaching Silicon Etch Process using Animations and MEMS Simulation Tools

Somashekara BHAT and Shailendra Kumar TIWARI

MIT, Manipal, Karnataka, India, 576104

E-mail: soma.bhat@manipal.edu, Phone +91-820-2924821; Fax +91-820-2571071

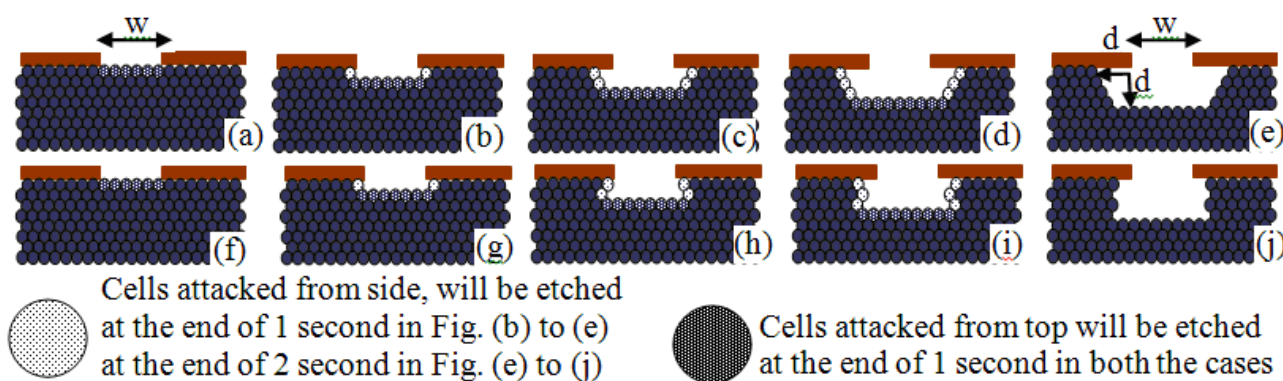
### Abstract

One of the main challenges faced by the teacher and the beginner in Micro Electro Mechanical Systems (MEMS) is; teaching and learning the orientation dependent etch properties of silicon. KOH is one of the popular etchant used in bulk silicon wet etching, however, its etch properties are orientation dependent. During the etch process, the structure undergoes many 3-D changes in shape. It becomes a Herculean task for the teacher to teach this etch process. Through this paper an attempt is made to explain how effectively computer simulations and animations can be used in the etch process.

**Keywords:** Wet etching, Silicon, Simulation, Intellisuite, Concave and Convex Corners

### 1. Introduction to wet etching

In MEMS, micromechanical components are fabricated using micromachining processes. Wet silicon etching processes use liquid chemical solutions in contact with silicon. If the etch rates in all directions are identical, the etching is said to be isotropic and if the etch rate is orientation dependent, the etching is said to be anisotropic. For the students to understand the etch process clearly, following exercise can be given. Figure 1 (a) and (f) shows a window opened in a wafer for etching purpose. i) If the cells that come in contact with the etchant get removed in 1 second, delete all the cells that are removed at the end of 4 seconds. ii) Assume that only cells that are attacked by the etchant from the top are removed in 1 second and if it is attacked from the side, it needs 2 seconds to be removed. Delete all the cells that are removed at the end of 4 seconds. In both the cases assume that the fresh cell is attacked only after present cell is removed completely. For simplicity assume that etching takes place only inside the window.



**Figure 1** (a) and (f): Wafer with square window opened using photo resist and ready for etching

(b) to (e): Cross-section of the etch profiles after 1, 2, 3, and 4 seconds of etching with etch condition of; cells that come in contact with etchant get removed in 1 second

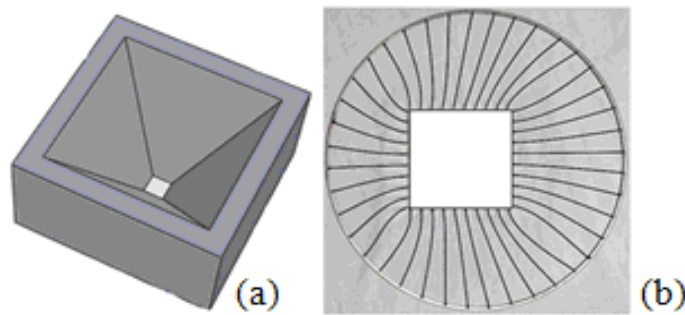
(g) to (j): Cross-section of the etch profiles after 1, 2, 3, and 4 seconds of etching with etch condition of; cells that are attacked by the etchant from top are removed in 1 second, if it is attacked from side it needs 2 seconds to be removed

The etch process at the end of each second is shown in Fig. 1 (b) to (e) and Fig. 1 (g) to (j) for the two cases respectively. To certain extent this exercise will help him to understand the difference between etch

process. Student will again face a problem if he/she is asked to draw the 3-D view of the final pattern. It is possible that the student draws the 3-D view shown in Fig. 2(a). This is applicable only when the etching is anisotropic. When the etching is isotropic, we get a 3-D view of Fig. 2(b) which is like a bowl with square bottom of size ( $w \times w$ ) and circular top with diameter of  $(w+2d)$ .

### 1.1 KOH as wet etchant in silicon etching

KOH is one of the wet etchant popularly used in silicon etching. It is an orientation-dependent etchant for Si. Solution with 20 wt % KOH in deionized water at  $80^\circ\text{C}$  removes the (100) plane at a much higher rate than the (110) and (111) planes. Typically this etch rate ratio is (100):(110):(111) planes = 400:600:1 and etch rate of (100) plane will be roughly  $85\mu\text{m/h}$  (Fig. 3). The etch rate of (111) plane is negligibly small ( $0.85\mu\text{m/h}$ ), hence orientation of (111) plane will decide the final etch pattern. Table 1 lists the angle between various planes. It is important to note that (100) and (111) planes make an angle of  $54.7^\circ$  between each other. This angle is an important number when we are working with (100) oriented wafer.



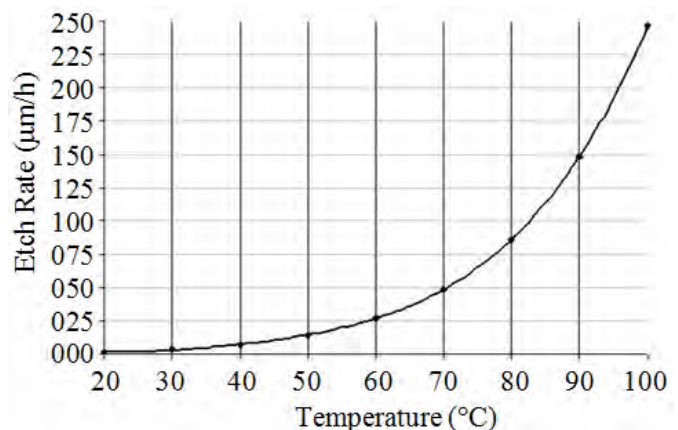
**Figure 2** 3-D view of the etch pattern with isotropic etch condition

(a): Wrong view, drawn as a chopped inverted pyramid. Representative diagram, courtesy [1]

(b): Correct view with square bottom (dimensions equal to that of square window ( $w \times w$ )) and circular top (with diameter equal to  $w+2d$ ). Representative diagram, courtesy [2]

Table 1: Angle between various planes [4]

	(100)	(110)	(010)	(001)	(101)
(100)	00.0	45.0	90.0	90.0	45.0
(011)	90.0	60.0	45.0	45.0	60.0
(111)	54.7	35.3	54.7	54.7	35.3



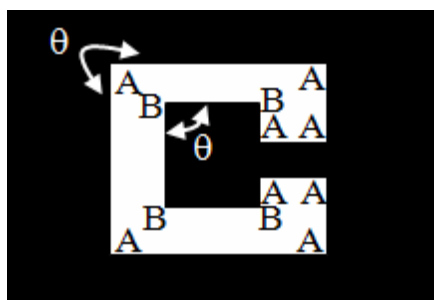
**Figure 3:** Etch Rate - Temperature plot for (100) oriented silicon wafer in 20 wt % KOH in DI water [5]

## 2 Computer Simulation Tools in Teaching Silicon Etching

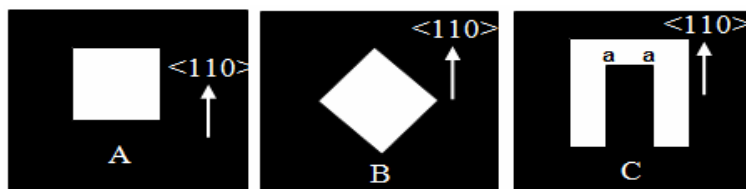
The corners of mask patterns help us to know the etching rules. At a convex corner, the solid angle of masked region is less than  $180^\circ$  (corners marked as 'B' in Fig. 4) and at a concave corner, the solid angle

of masked region is greater than  $180^\circ$  (corners marked as 'A' in Fig. 4). Convex corners tend to undercut rapidly, exposing fast etching planes and at concave corners, slow etching planes such as  $\{111\}$  tend to develop and eventually prevail. This is an important conclusion we draw and this will help a beginner to design appropriate mask patterns.

Figure 5 shows mask patterns named A to C. Assume that these mask patterns are used in etching a (100) wafer. In case of 'A'; the sides of the window are aligned along  $\langle 110 \rangle$  directions. In this case all the corners are concave and hence slow etching (111) planes decide the final shape. These (111) planes make an angle of  $54.7^\circ$  with respect to top (100) surface. Thus resulting pattern will have 4 side walls making an angle of  $54.7^\circ$ . The final shape can be any of the three shown in Fig. 6(a) to (c) depending on the window size and etch conditions.

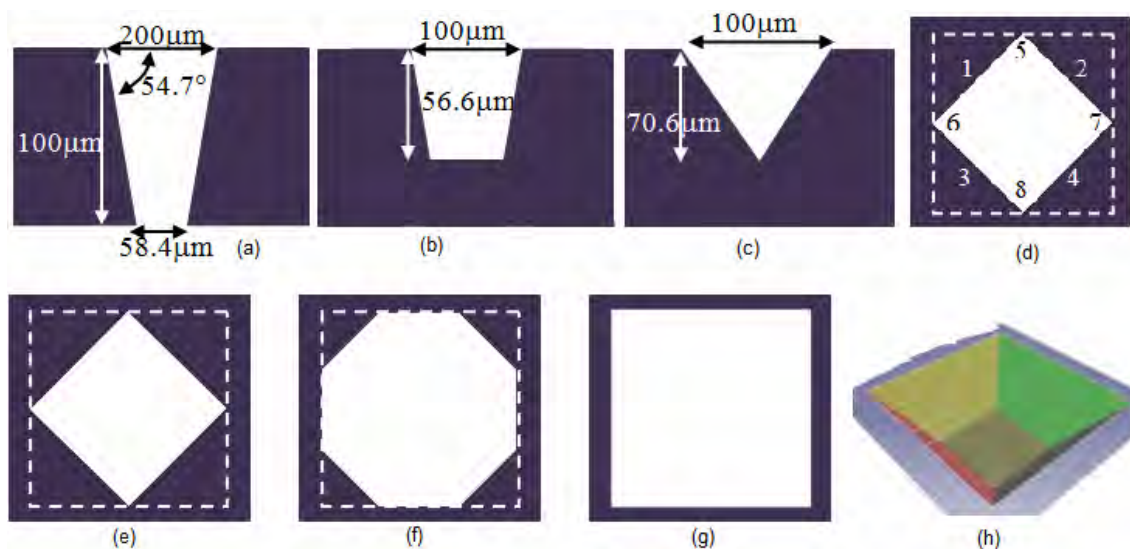


**Figure 4** Patterns showing Concave and Convex Corners



**Figure 5** Mask Patterns used for predicting and simulating etch process

In case of pattern 'B'; the sides of the window are aligned at an angle of  $45^\circ$  to the  $\langle 110 \rangle$  directions. The regions between the two concave corners (regions 1, 2, 3 & 4 in Fig. 6(d)) are not protected by the slow etching (111) planes, instead they are now exposed through fast etching (110) planes. As shown in Fig. 6(e) to (g); the etch pattern will start as a square (of sides  $w \times w$ ), will change to an octagon and finally to a square of sides  $\sqrt{2}w \times \sqrt{2}w$ . However; for a beginner and someone who is poor in drawing, it is challenging to draw the 3-D view of the resulting transitional patterns. This is because, with respect to (100) planes, (111) planes will be at an angle of  $54.7^\circ$  and (110) planes will be at an angle of  $90^\circ$  (Refer Table 1). One can perform series of computer simulations to get a hold over predicting the final etch patterns correctly. One needs to take a mask pattern, and predict the final pattern with the help of above discussions. Then perform a etch simulation using Intellisuite<sup>®</sup> software (can be any other software which has this feature) and match the resulting pattern with the predicted pattern. Some exercises are given in Table 2. The respective simulation videos (refer last but one column in Table 2) help us to get a better understanding of the etch process.



**Figure 6** (a) to (c) Cross-section of possible etch patterns depending on mask opening ( $w$ ), wafer thickness ( $t$ ), and etch time ( $T$ )  
 d) Mask pattern of 5(B); corners 1, 2, 3 & 4 point to fast etching (110) planes, hence their etch rate and orientation decides the etch profile. Corners 5, 6, 7 & 8 point to slow etching (111) planes.  
 e) & f) Top view (only top part) of the resulting transitional patterns when mask pattern of 5(B) is used  
 g) Final etch pattern when mask of 5(B) is used. Top window size will be  $\sqrt{2}w \times \sqrt{2}w$  ( $w \times w$  is the initial window size)  
 h) 3-D view of the resulting final pattern when mask pattern of 5(B) is used [6]

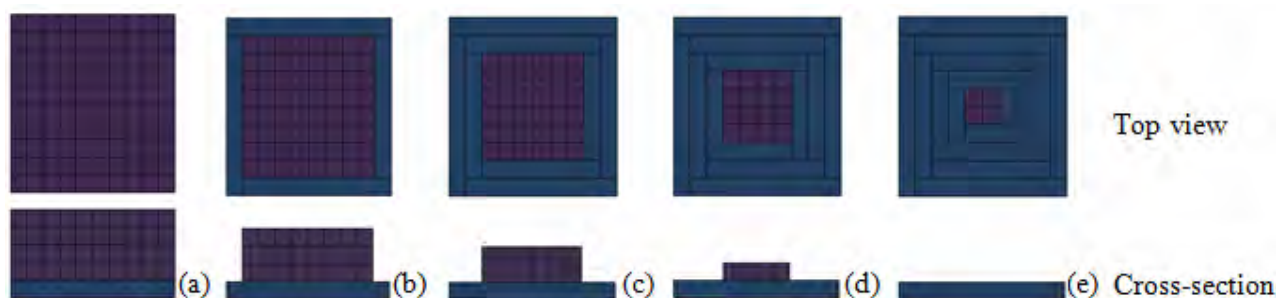
**Table 2** Mask dimensions, types and etch specifications. For all the cases; Etch rate of (100) plane is  $85 \mu\text{m/h}$ , Etch rate of (111) plane is neglected, Wafer thickness is  $100 \mu\text{m}$

Mask	Window ( $\mu\text{m}$ )	Etch time (minutes)	Video	Remarks
Fig. 5(A)	100 x 100	40	<a href="#">7(A)_100X100_40min</a>	Faces at $54.7^\circ$ , Top chopped Inverted pyramid
		100	<a href="#">7(A)_100X100_100min</a>	Faces at $54.7^\circ$ , Inverted pyramid
		100	<a href="#">7(A)_200X200_100min</a>	Faces at $54.7^\circ$ , Through hole, Inverted pyramid,
Fig. 5(B)	100 x 100	20	<a href="#">7(B)_100X100_20min</a>	4 corner faces at $90^\circ$ 4 side faces at $54.7^\circ$ Octagon
		40	<a href="#">7(B)_100X100_40min</a>	4 faces at $54.7^\circ$ , Square with sides $100x\sqrt{2}$
		100	<a href="#">7(B)_100X100_100min</a>	4 faces at $54.7^\circ$ , Square with sides $100x\sqrt{2}$ , Through hole
Fig. 5(C)	100 x 100 Central beam: 25 x 50	10	<a href="#">7(C)_100X100_10min</a>	Faces at $54.7^\circ$ , partial undercut below the beam
		40	<a href="#">7(C)_100X100_40min</a>	Faces at $54.7^\circ$ , complete undercut below the beam resulting in cantilever of mask material (pink colour)
		100	<a href="#">7(C)_100X100_100min</a>	Faces at $54.7^\circ$ , inverted pyramid, complete undercut below the beam resulting in cantilever of mask material

In the case of mask pattern of Fig. 5(C), there are two convex corners (marked as 'a'), hence mask will not be able to protect the region below it. In the final stable pattern, the entire region below this will be etched and the resulting pattern is shown in Fig. 6(h). From this 3-D view it can be understood that, at the end we get a cantilever structure made of mask material. This understanding can be used in realising a MEMS cantilever beam.

### 3. Computer Animation in Teaching Polycrystalline Silicon Etching Using HNA

Polysilicon is one of the popular structural materials used in surface micromachining and below this  $\text{SiO}_2$  is commonly used as sacrificial layer. Wet etching of Polysilicon is performed using  $\text{HNO}_3$ , de-ionized water and HF in the ratio of 100 ml: 40 ml: 7 ml (HNA). As it is an isotropic etchant, etching takes place on all sides.  $\text{SiO}_2$  below gives a feeling that etching occurs only on sides and gives an impression that etching will take a long time, but in practice it finishes in no time. This process can be effectively explained using following exercise. Consider a Polysilicon (■) film of area 10x10 cells and thickness of 4 cells over a  $\text{SiO}_2$  (■) film as shown in Fig. 7(a). Assume that the cells in contact with HNA are etched at the end of 1 second. Draw the etch patterns at the end of 1, 2, 3, and 4 seconds by deleting the cells being etched. The etch patterns at the end of 1 to 4 seconds is shown in Fig. 7(b) to (e). It is important that, a student performing etch process can see only the top view, thus he gets a feeling that etching takes place only through sides. If the etch area is large when compared to thickness, it is the thickness that will decide the time required to etch the entire film than the area. As the student cannot observe the changes taking place along the thickness, there is always a chance of getting the timing wrong. As he is seeing the top view (Fig. 7), he feels that the film will be etched completely at the end of 5 seconds, but actually film gets etched completely at the end of 4 seconds. Note that as long as film thickness is 4 cells, irrespective of the film area, the film will be etched at the end of 4 seconds.



**Figure 7** Polysilicon etch patterns in HNA;

a) Initial film with Polysilicon (■) of 10x10 cell area and 4 cell thickness over  $\text{SiO}_2$  (■)

b) to e) Cells etched at the end of 1, 2, 3, and 4 seconds respectively. Observe that, even though top view shows that there are 4 cells left, cross-section shows that there are no cells left

### 4. Conclusion

This paper has made an attempt to explain how a simulation tool or animations can support the teacher and the student in teaching/learning the etch process. A teacher teaching the above etch processes using chalk and board would take 2-3 hours in drawing and teaching the patterns. If he is poor in drawing, he may fail to convey the etch process. Instead if he uses a simulation tool like Intellisuite and grabs frames at various time intervals and presents it as a video or using animation he can save his time and he can effectively explain the etch process.

### 5. References

1. <http://www.artwork.com/micronic/stl2mic/index.htm>
2. <http://www.etsy.com/search?includes%5B%5D=tags&q=square+bottom+bowl>
3. [http://www.crystal-scientific.com/xtal\\_orientation.html](http://www.crystal-scientific.com/xtal_orientation.html)
4. [http://www.cleanroom.byu.edu/EW\\_orientation.phtml](http://www.cleanroom.byu.edu/EW_orientation.phtml)
5. <http://www.cleanroom.byu.edu/KOH.phtml>
6. Chang Liu, Foundations of MEMS, Prentice Hall, 2011.

## Promoting inquiry-based practical chemistry using SOLO taxonomy

Päivi TOMPERI and Maija AKSELA

*The Unit of Chemistry Teacher Education, Department of Chemistry, University of Helsinki*

*Address: P. O. Box 55, FI - 00014 University of Helsinki, Finland*

*Email: paivi.tomperi@helsinki.fi*

*Telephone number: +358504364390 - Fax number: +358919150466*

### Abstract

*Educational design research is a systematic study of designing, developing and evaluating educational programs, processes and products. The aim of design is a training course that promotes inquiry-based approach in practical chemistry instruction at the upper secondary level. According to preliminary research, a prototype of a voluntary supplementary training course was planned and carried out for twelve in-service high school chemistry teachers lasting for three months. In the beginning teachers were introduced the SOLO (= Structure of the Observed Learning Outcome) taxonomy as a tool to evaluate the quality of written instructions found in the chemistry books from where teachers prefer choosing assignments for practical lessons. Teachers were also introduced the action research methodology to investigate the results of their actions in the classroom. All the participants answered to the questionnaire afterwards. Four teachers were interviewed and the results were obtained using qualitative content analysis. It came evident during interviews that teachers are reluctant to use inquiry approach in practical chemistry because it takes too much time from content coverage and practical chemistry plays only a minor part in matriculation examination. The experiences during the first case study led to changes in the second implementation of the course. We shall discuss the results obtained from the first design experiment.*

**Keywords:** practical chemistry, inquiry, educational design research, the SOLO taxonomy

### Introduction

Chemistry laboratory can foster higher order thinking skills and metacognitive skills provided that laboratory activities are carefully planned and conducted [1-2]. Research review indicate that the inquiry-based instruction where the hands-on practical work is included through the investigation cycle (i.e. generating questions, designing experiments, collecting data, drawing conclusion and communicating findings) improves conceptual learning [3]. Finnish high school curriculum in chemistry supports the role of laboratory in chemistry learning. However, laboratory activities are not attempting to students and teachers due to the high theoretical content and because the matriculation examination is purely a written test. It is also well known that school books play a central role in focusing student's behavior and learning.

Laboratory activities should match the developmental level of students and encourage them to move towards more sophisticated laboratory experiments of which they don't have experiences yet. Teachers should evaluate the written instructions carefully to find out what is expected from the learner in order to perform the task. To improve practical chemistry instruction at an upper secondary level a model for an in-service training course was created to establish inquiry-based teaching and learning. During the course we introduced chemistry teachers the SOLO taxonomy as a tool to predict the quality of learning accessible for students with the laboratory task at hand.

### The SOLO Taxonomy

Inspired by the work of Marton and his colleagues [4] Biggs and Collis created the SOLO taxonomy



which illustrates the continuum from surface to deep learning [5-6]. It is based on the Piaget's sequence of cognitive development reflecting the understanding of science at five hierarchical levels where each level builds at the skills that were acquired at the previous one. The first three levels, *prestructural*, *unistructural* and *multistructural* levels, correspond to the traditional verification laboratory experiments in which the aim is to follow the written instructions and to solve problems from one to several separate aspects without any need to form relation between the two or more aspects. This kind of instruction is used when something is done for the first time i.e. introducing a research method. The first three levels are quantitative in nature and represent a superficial approach for learning. They are, however, the entrance for students to the qualitative levels of the SOLO taxonomy, namely to the relational and the extended abstract levels. Inquiry type of assignments usually requires prior experiences with inquiry and some prior knowledge and skills to succeed. The optimal level of inquiry to employ depends on students' capabilities: the greater the skill level and the knowledge of students, the higher level of inquiry, *structured*, *guided* or *open* inquiry, can be employed [7]. In fact, because learners are usually dealing with new information at high school, minimal guidance or open inquiry type of assignments do not work well in such learning situations. Students need to be explicitly shown what to do and how to do things. Problem solving activities often generate a heavy working memory load and thus may lead to poor learning especially in the case of novice learners whose schemas are inadequate to integrate the novel information with their prior knowledge. [8]

When there are enough aspects available concerning the issue to be investigated at the quantitative level, the relations between separate aspects start to emerge in students' minds and by supportive discussions with peers and the teacher, they may integrate into a coherent whole [5]. At the fourth level of the SOLO taxonomy, the relational level, students are guided and supported to draw a general conclusion from the data by induction. At the fifth SOLO level, the extended abstract level, students are also able to generalize the abstract principle to another context outside their own experience by deduction.

The SOLO taxonomy can also be understood as a cycle or spiral of learning: at first, experiences obtained through detailed instructions are needed to become familiar with the idea under investigation and gradually skills are developed and practiced until the goal is reached i.e. to run the research independently: to pose relevant questions, gather data, construct explanations and communicate results.

### **Research Methodology**

Educational design research (EDR) is a systematic study of designing, developing and evaluating educational programs, processes and results. The framework for an EDR is pragmatism because the knowledge about chemistry teaching and learning and teachers' actions in the classroom are closely connected. When teaching is reflected, knowledge about teaching and learning is obtained and as one's understanding of teaching experience broadens, it will influence teaching. Three features determine EDR: 1) A design process is iterative in nature; 2) objective is to develop an artifact to help teachers and students to act more rationally; 3) it provides new knowledge about teaching and learning. [9 - 10]

According to a preliminary research, a model for a voluntary training course was planned (Figure 1) and carried out for twelve in-service high school chemistry teachers in the North of Finland lasting for three months. It included two days of contact lessons and workshops, namely one Saturday in the beginning and one Saturday in the end of the course. Between the two meetings the researcher was tutoring in the internet learning environment which was built for information exchange and collaborative knowledge building.

After the course all participants answered to the questionnaire. Four teachers were selected for an interview from the same town for convenience and the results were obtained using qualitative content analysis. The results and experiences during the first case study, the first cycle in the EDR, led to changes in the second implementation of the course.

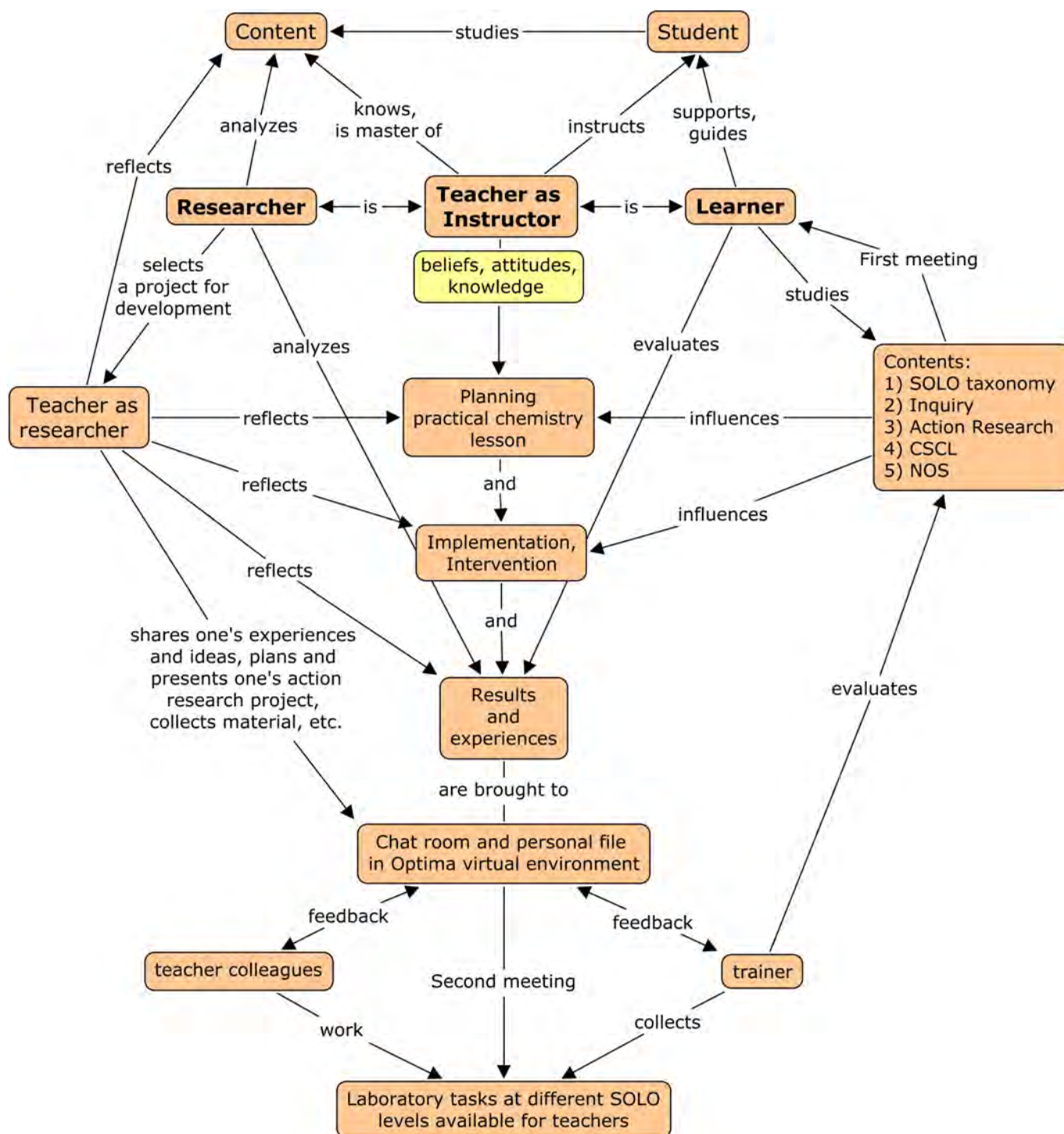


Figure 1 Concept map of the in-service teacher training model

### In-service Teacher Training Model

The goals for the in-service training course were 1) to introduce SOLO tool to improve the quality of instruction, 2) to collect and modify laboratory tasks using SOLO tool and to test them in real situations at schools for evidence, 3) to inform teachers up-to-date research findings in practical chemistry, 4) to offer opportunities for teachers to practice computer supported collaborative learning (CSCL) skills in the virtual learning environment and 5) to introduce action research methodology to acquire personal experiences of inquiry. Introducing the SOLO tool aimed also at creating of constructive dissatisfaction for teachers with their practical chemistry instruction to motivate them to change their practices. [11]

The upper part of the model in the concept map (Figure 1) is didactic triangle according to Herbart. It describes the relation between the student, the teacher and the content. One side of the equilateral triangle represents the pedagogical relation between the teacher and the student and the relation between the teacher and the content depicts teacher's expertise in a subject matter. The relation between the student and the content is called didactic relation and it is a foundation of subject didactics. It establishes teacher's relation to studying and emphasizes teacher's personal responsibility in educational decision making. [12] In the Finnish teacher training the aim has been to educate teachers as researchers and lifelong learners capable of reflecting on their own work for professional competence. The goal of research-based teacher education is the making of educational decisions based on rational argumentation in addition to intuitive argumentation. [13] The model emphasizes the balance between the three roles of the teacher as an instructor, as a researcher and as a learner to afford professional growth. As a researcher teacher analyzes the content which in this case comprises the written instructions of the laboratory assignments using the SOLO tool.

Teacher as a learner is an important model and support for a student in learning process and in the development of metacognitive skills. In the in-service training course teacher is a learner and the studying of the contents introduced and practiced during the training course may influence the planning, implementation and evaluation phases of the practical lesson. Teachers plan a practical chemistry lesson and carry it out according to a plan and obtain results and experiences which they share with other course participants and the trainer in the virtual learning environment. Teacher as a researcher selects a laboratory work and modifies it according to goals and student skills and reflects the professional experimentation from the planning to implementation in the classroom and evaluation. The "undirect" path to teacher's belief system can only be reached through personal reflection. Teacher interpreted change is the only consequence of teacher experimentation that is known to be crucial to subsequent change in teacher knowledge, attitudes and beliefs. [14]

## Results

Interviewed teachers described their practices to be content driven where the main goal is to prepare students for course exams and for the matriculation examination. Teachers employ on an average two laboratory tasks at a course. In that context developing practical chemistry instruction appears to them too much time consuming a task.

Virtual learning environment was built for communication and collaborative knowledge building between the two meetings and tutoring aimed at supporting the active participation in the course. The trainer was easily reached during the whole course through the virtual learning environment or by email. However, it became evident that it was too difficult for teachers to share incomplete work and personal experiences with colleagues. Many of them submitted the given assignment to their personal files but the discussion around them died out quickly. So the goal for producing tested teaching material collaboratively at different SOLO levels was not obtained. According the feedback given in the questionnaire afterwards more training would have been needed to encourage teachers to experiment on their own at schools. On the other hand, two teachers told during the interview about inquiry type of activities that they had done according to the original plan in the course. Despite they had obtained good results and positive experiences and they expressed willing to continue with similar type of experiments in the future, they preferred not to communicate it to others.

The SOLO tool succeeded in raising teachers' awareness of how the quality and characteristics of written instructions predict student performance in a laboratory. During interviews they brought up ideas and examples spontaneously of how the expository assignments demonstrate low student achievement and expressed the need to transform the written instructions into a more open type of problem solving task at higher SOLO level.

Most teachers rejected open inquiry but considered structured and guided inquiry approach feasible especially in a separate laboratory course in which the group size is small and students are motivated. The interviewees' opinion was that the curriculum does not support inquiry-based teaching and learning at high school.

## References

1. D. S. Domin, *J. Chem. Educ.*, 1999, 76, 543.
2. A. Hofstein, V. N. Lunetta, *Sc. Educ.*, 2004, 88, 28.
3. D. D. Minner, A. J. Levy, *J. Century, J. Res. Sc. Teach.*, 2009, 1,1.
4. K. Marton, R. Säljö, *Brit. J. Educ. Psyc.*, 1976, 46, 4.
5. J. B. Biggs, K. F. Collis, *Evaluating the quality of learning: the SOLO taxonomy*, Academic Press: New York 1982.
6. J. B. Biggs, *Students approaches to learning and studying*, Australian Council for Educational Research: Melbourne 1999.
7. E. Abrams, S. A. Southerland, C. Evans: *An Introduction to Inquiry*. In E. Abrams, S. A. Southerland, P. Silva (eds.) *Inquiry in the classroom: Realities and opportunities*, pp. i – xii, CT: Information Age Publishing, Greenwich, (2007)
8. P. A. Kirschner, J. Sweller, R. E. Clark, *Educ. psychologist*, 2006, 41, 75.
9. D. Edelson, *J. Learn. Sc.*, 2002, 11, 105.
10. K. Juuti, J. Lavonen, *NorDiNa*, 2006, 4, 54.
11. J. Dillon: *Managing science teachers' development*. In R. Millar, J. Leach, J. Osborne (eds.) *Improving science education. The contribution of research*, pp. 94 – 109, Open University Press, Buckingham, (2000)
12. P. Kansanen, M. Meri: *The didactic relation in the teaching-studying-learning process*. In B. Hudson, F. Buchberger, P. Kansanen, H. Steel (eds.) *Didaktik/Fachdidaktik as science(-s) of the teaching profession*. TNTEE Publications, 1999, 2, 107
13. P. Kansanen: *Research-based teacher education*. In R. Jakku-Sihvonen, H. Niemi (eds.) *Education as a societal contributor*, pp.131 – 146, Peter Lang: Frankfurt am Main, (2007)
14. D. Clarke, H. Hollingsworth, *Teaching and Teacher Educ.*, 2002, 18, 947

## Students creativity in chemistry classes

Dragica TRIVIC<sup>1</sup>, Biljana TOMASEVIC<sup>1</sup>, Ivana VUKOVIC<sup>2</sup>

<sup>1</sup>University of Belgrade, Faculty of Chemistry, Studentski trg 12-16, Belgrade, Serbia

<sup>2</sup>Mathematical Grammar School, Kraljice Natalije 37, Belgrade, Serbia

e-mail: dtrivic@chem.bg.ac.rs, telephone: +381113336854, fax: +381112184330

### Abstract

*In this paper the effects of the elaboration of the Stoichiometry by different teaching/learning methods, according to aims to encourage divergent thinking and creativity of primary school students (aged 13), is presented. The pedagogic experiment with parallel groups was carried out within six sessions during the 2010/2011 academic year. Two seventh grade classes (50 students) from Mathematical Grammar School in Belgrade were chosen as a sample. One group (group A) was taught by a combination of the demonstration methods and the stoichiometry calculations. The other group (group B) were divided into several groups and each of them had a few tasks: (i) to conduct experiments and according to results to create stoichiometry problems, and (ii) to read the text and according to the information from text to develop stoichiometry problems.*

*At the pre-test, the group A showed a slightly higher overall result than the group B. The results of post-test show that the great number of different types of responses was given in group B. The obtained results show that an opportunity to create stoichiometry tasks associated with the experimental work or with the texts can contribute to the development of students divergent thinking.*

**Keywords:** creativity, convergent/divergent thinking, stoichiometry, teaching/learning methods, evaluation

### Introduction

Creativity and innovation are becoming increasingly important for the development of contemporary society. Education is seen as central in fostering creative and innovative skills of youth [1]. Creative problem-solving is an essential facet of scientific thinking. An emphasis on creative problem solving in science education can help to better preparation of students for scientific and technological problem-solving and related careers [2]. However, the central concern of most science teachers is the transmission of the products of “the context

of epistemological justification”- that is a narrow focus of “what we know” rather than “how we know” [3]. Although, the production of novel or aesthetic ideas or products in domain of arts, science or technology are results of creative thinking, there are implicit views that science and education has an indirect connection with creativity [4].

The involvement of creativity in education comprises that teachers must understand and be able to do these kinds of things themselves, as well as to demonstrate them in the ways they work with students, specific subject matter, and the things that students create. Teachers should give students opportunities to connect and combine; to work with the artistic, scientific, and historical modes of thought; to communicate in verbal, mathematical, kinesthetic, musical, and visual languages; to understand and use frameworks as springboards for their creativity; and to enjoy the fact that many problems with a single answer have multiple solutions, and that many more problems have no universally right or best answer [5,6].

Chemistry as a part of science is an essential domain of the school curriculum. The chemistry teaching has the potential to encourage students to think flexibly in order to increase a variety of approaches to solving problems and, in that way, to contribute to development of learners creative capacities. The assumption that chemistry can stimulate creativity depends on the way chemistry is taught.

The aim of this study was to investigate the contribution of different methods of the *Stoichiometry* elaboration to the development of divergent thinking and creativity of primary school students (aged 13). The following issues and challenges had raised for us when we attempted to develop creative capacities of pupils related to stoichiometry calculations:

- How to design strategies to motivate students, to facilitate their learning process and to stimulate their creative thought related to stoichiometry calculations? What are the strategies that stimulate the generation of ideas?
- How to stimulate creativity process in regular chemistry classes, within the existing curriculum and other circumstances in schools?
- What are the conditions (internal and external to the individual) that support the process and creative expression in chemistry teaching/learning?
- How to monitor and evaluate students' creativity, which kind of instruments we can use for that?

The theme *Stoichiometry* was selected because it is the important part of primary school chemistry curriculum, which connects macro and micro level of concept of substance (corpuscular structure and changes). On the other hand, the stoichiometry is strongly connected with a convergent thinking. It was the next challenge for us to develop an approach that encourages and supports students divergent thinking on quantitative aspects of chemical reactions.

Also, we keep in mind that the knowledge base plays a key role in *all* thinking processes, convergent and divergent. Thus, it is a critical component of creative thinking and problem solving. 'Domain specific knowledge' is a major factor in creative thinking processes [7]. The science is a creative endeavour and that requires to generate opportunities for individuals to: 1) acquire a high level of domain-specific knowledge; 2) practise application of that knowledge in developing solutions to problems across a gradient of difficulty and; 3) be challenged to integrate their knowledge of science with their knowledge of other fields to pursue and solve problems with personal relevance [8].

## Methodology

The effects of the elaboration of the *Stoichiometry* by different methods of teaching were tested in a pedagogic experiment with parallel groups. The research was carried out within six sessions during the 2010/2011 academic year. Two seventh grade classes (50 students) from Mathematical Grammar School in Belgrade were chosen as a sample. One class was assigned as group A and another as group B. The Mathematical Grammar School is a unique school in Serbia, specialised for students talented in mathematics, physics and computer science, aged 13-18 (the School includes the two final grades of primary school, age 13-14).

At the beginning (the first session) the students of both groups were asked to do a pre-test (TEST 1). The next two sessions in both groups is devoted to introduction of stoichiometry area and the consideration of a mole, mass and number of particles relationships, as well as the illustration of solution of some stoichiometry problems. The next two sessions in the group A were realized by the combination of experiments demonstrations and stoichiometry tasks exercises. During this period the group B was divided into several groups and each of them was assigned by two main tasks:

- to conduct experiments and according to results to create stoichiometry problems, and
- to read the text and according to the information from text to develop stoichiometry problems.

At the end of the experiment, a post-testing (by TEST 2) was organized in order to examine the contribution of different teaching/learning methods to the development of divergent thinking in both groups.

## Results and discussion

At the pre-test, the group A showed a slightly higher overall result than the group B, but, at the post-test, the group B showed improvement in comparison with the group A (Table 1).

**Table 1.** The characteristics of distribution of the results achieved in the Test 1 and Test 2.

Group	Test 1		Test 2	
	A	B	A	B
Number of students	25	25	25	25
Mean value	18,6	16,8	23,3	24,0
Standard deviation	4,9	4,5	6,6	5,1
Percentage of correct answers	74	67	66	68

A slightly better result of the students from group B in the final test unquestionably recommends such an approach in acquiring knowledge in stoichiometry. The analysis of the correct answers was far more important than the sole analysis of the general success in the test, due to its diversity.

The tasks in test 2 that encourage students divergent thinking are shown in the table 2. After the collection and evaluation of all student answers we have divided acceptable students answers according to similarity of expression into several categories. The examples of the categories are shown in table 2.

The percentage of different categories of answers related to tasks 1-3 are presented on the figures 1 -3. As we can see the students from group B produced more different categories of answers than the students from group A.



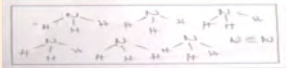
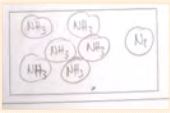

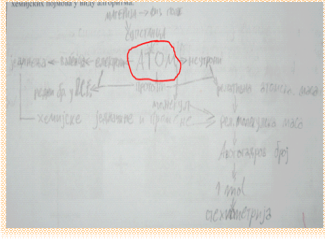
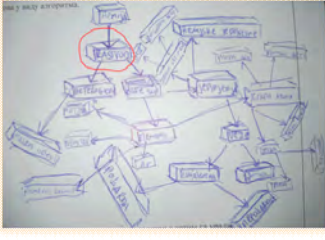
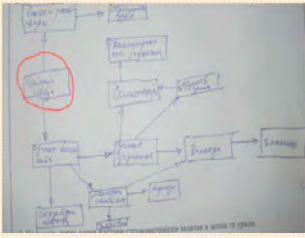
In the first part of the test students presented the products of the chemical reaction in the given mixture of gases. The answers of the A group students in this first part of the test were given in exactly the same way in which the task was formulated through drawing of the molecule models. Solving of the arithmetic operations in stoichiometry obviously could not influence those students to see and apply their gained knowledge in any different context or situation. Sole practicing solving tasks through means of certain defined algorithms had one result: the students were merely successful in solving those particular tasks. Unlike those A group students who were watching the demonstrated experiments, B group student gained their knowledge through their experimental work. They had a set of different activities, from following the instructions and performing the experiment, noting down their remarks, formulating their explanations and conclusions to individual formulating and solving of the stoichiometry problems. The task of formulating problems referring to their experiment and all related texts given to them, put the students in a completely new position, much more different from the one in which they are often put. They mutually analyzed given tasks, suggested improvements which helped them to apply their already gained knowledge and considered different methods and approaches in solving problems. Most students were obviously tempted to present their solutions and conclusions in a manner completely different from the one presented in their original task.

We also believe that such an approach particularly influenced the results in the third task. Almost all A group students (91%) formulated a stoichiometric problem with simple relations of mass-amount-Avogadro's number, without any particular context. There were 55% of such problems in group B, 30% of the problems in which there was a surplus of a certain substance, and there was 15% of the problems in which the substance was given as the certain percentage of the content. This was evidently the result of the situation when the students were asked to formulate problems, comment and analyze the other students' problems.

The intention of the second task was to check whether the students of both groups involve the concepts related to quantitative aspects of chemical reaction in general system of concepts and what are the position of these concepts like. We have found two categories of concept maps in group A, developed from concepts of substance and atom, and five categories of maps in group B. It is interesting that besides

the maps with substance and atom as the central concepts, the students from group B developed concepts map with solution and Periodic table as the central concepts, as well as the maps that characterise historical approach to chemistry concepts (Figure 2).

**Table 2.** Test 2 items and given students answers.

Test 2 items	Category of answers
<p>1. Nitrogen and hydrogen react to form ammonia. Consider a mixture of nitrogen and hydrogen shown in the diagram. If the chemical reaction occurs in the system, how will you present that?</p> 	 <p>The solution involves the drawings of models of molecules.</p>  <p>The solution involves the structural formulas of the components of system.</p>  <p>The solution involves the molecular formulas of components of system.</p>
<p>2. Draw a map of concepts learned during the school year.</p>	 <p>Substance as central concept</p>  <p>Atom as central concept</p>  <p>Solution as central concept</p>  <p>History of chemistry approach to development of concepts' map</p>



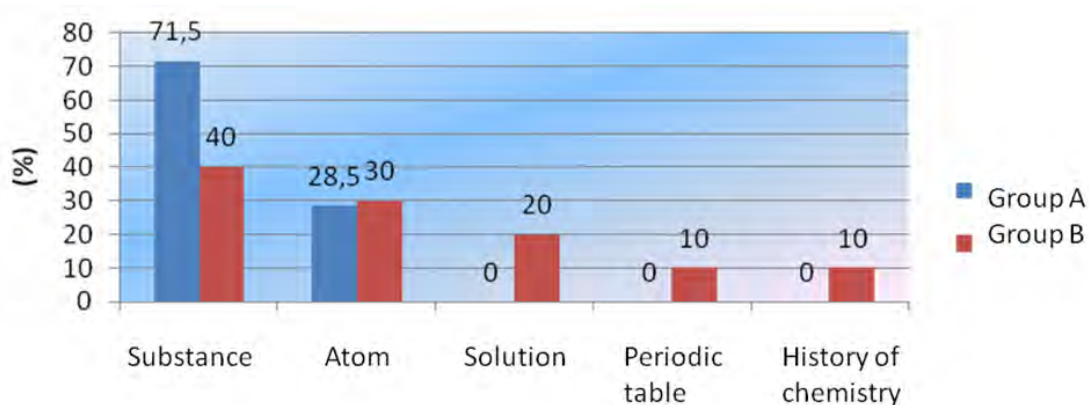


Figure 1. Percentage of different categories of answers for Task 1

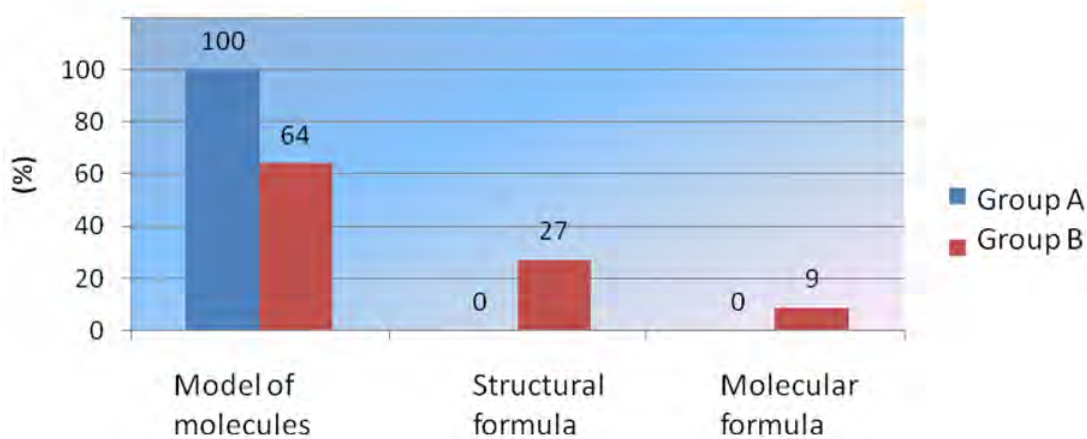


Figure 2. Percentage of different categories of answers for Task 2

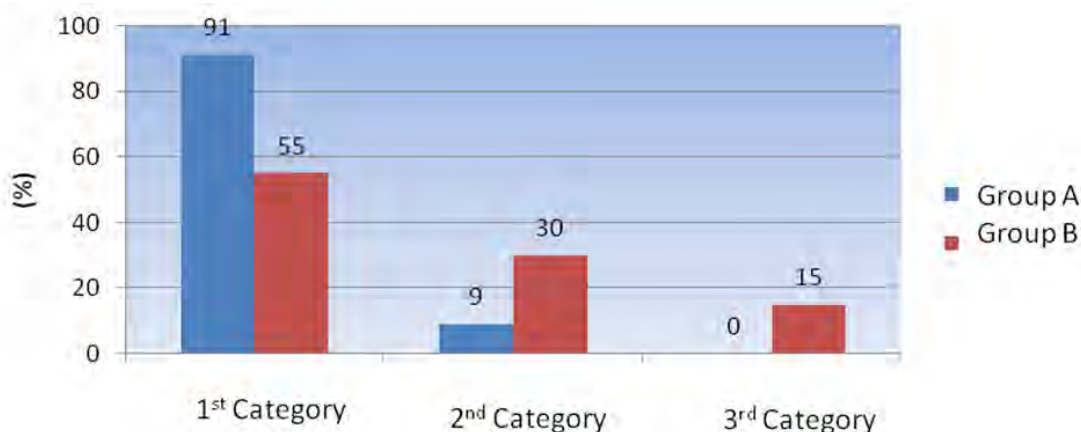


Figure 3. Percentage of different categories of answers for Task 3

## Conclusion

It is often thought that stoichiometry, due to its convergency in solving problems through which students acquire their knowledge in this field, does not offer enough means of encouragement and particularly creativity. The presented model of a lesson in stoichiometry and the presented results clearly prove that we can encourage students to present and apply their knowledge in a more creative way by means of using certain activities. In those lessons students conducted a set of different activities: individual conducting of the experiments, noting down the results, giving explanations, making conclusions, indivi-

individual formulating of stoichiometric problems for the given task, introducing themselves with new situations in which they can apply their knowledge, and suggesting improvements for the problems created by other students. All this made that the results of post-test showed the great number of different types of responses was given in that group (group B). According to that we can say that applied teaching methods have the potential to contribute to development of divergent thinking of students. The traditional approach in teaching stoichiometry (frontal method, teacher presenting facts, demonstrated experiments, practicing solving the arithmetic problems) does not encourage the divergent thinking and students' creativity.

It is also important not to exclude any teaching content in chemistry in advance as inappropriate for showing students' creativity. We all agree that it is not easy to prepare teaching situations which allow acquiring knowledge and assessment of it without being limited by a defined and expected answer on the side of the student. Assessment and evaluation of the divergent answers are the most requiring part of the presented method.

Nevertheless, it stimulates students' creativity requires to be open to take risks, to try new ways, and to manage mistakes in order to learn from them.

### **Acknowledgement**

This work was supported by the Ministry of Education and Science of the Republic of Serbia (Grant No. 179048).

### **References**

- [1] A. Ferrari, R. Cachia, and Y. Punie, Innovation and Creativity in Education and Training in the EU Member States: Fostering Creative Learning and Supporting Innovative Teaching, 2009. [http://ftp.jrc.es/EURdoc/JRC52374\\_TN.pdf](http://ftp.jrc.es/EURdoc/JRC52374_TN.pdf)
- [2] J. A. Plucker, What's in a Name? Young Adolescents' Implicit Conceptions of Invention, *Science Education*, 2002, 86, 149, DOI 10.1002/sce.10011
- [3] H. Bartholomew, J. Osborne and M. Ratcliffe, Teaching Students "Ideas-About-Science": Five Dimensions of Effective Practice, *Science Education*, 2004, 88, 655
- [4] L. Barrow, Encouraging Creativity with Scientific Inquiry, *Creative Education*, 2010, 1, 1
- [5] S. Hope, Creativity, Content, and Policy, SYMPOSIUM: TEACHING CREATIVITY, *Arts Education Policy Review*, 2010, 111, 2, 39
- [6] R. J. Sternberg, W. M. Williams, How to Develop Student Creativity, Association for Supervision & Curriculum Development, Alexandria, VA, USA 1996.
- [7] J. Feldhusen, Creativity: the knowledge base and children, *High Ability Studies*, 2002, 13, 2, 179
- [8] A. L. Schmidt, Creativity in Science: Tensions between Perception and Practice, *Creative Education*, 2011, 2, 5, 435

## Primary Student Teachers' Conceptions after Teaching about Matter and its Transformation: Conceptual Conflict Approach

Abdeljalil MÉTIOUI\*, Louis TRUDEL\*\*

\* *Département de Didactique, Université du Québec à Montréal  
Case postal 8888, succursale Centre-ville, Montréal (Québec) H3C 3P8  
metioui.abdeljalil@uqam.ca*

\*\* *Faculté d'Éducation, Université d'Ottawa, Ontario, Canada  
ltrudel@uottawa.ca*

### Abstract

*In this qualitative research, we demonstrate the relevance to teach to the Preservice primary school teachers the underlying basic notions of the physical transformations of matter. To this end, we took into account their conceptions before teaching and engaged them, while resorting to different didactic and educational supports as for example the ICT (information and communication technologies), in the hands-on laboratory and the confrontation of their conceptions. Thus, we succeeded in fostering the evolution of their erroneous conceptions toward more scientific conceptions, of 80 students in a teacher training course about science education, in the case of the physical transformations of matter.*

**Keywords:** Conception, after teaching, matter, conceptual conflict, preservice teachers, elementary school

### 1. Theoretical background

Since the advent of Piaget theory, much research has been done about pupils' conceptions (7 to 11 years old) of matter and its transformation [1]. Most of these conceptions have been identified as erroneous compared to scientific conceptions. For example, the majority of the pupils assign the same macro-properties to 'invisible particles' than those associated to the solids (hardness, heat, cold, color and physical state) to explain the dissolution of sugar in water [2]. From this example, one can conclude that the pupils, even before they receive any formal instruction, start interpreting, with the help of their naïve conceptions, the natural and constructed phenomena with which they are daily in interaction: "Thus children construct concepts about objects by acting on them, by seeing what they can be used for, or by seeing what happens to them when an action is performed" [2]. These conceptions are generally constructed from several sources such as their intuition or their spontaneous reaction, the daily use of the language, the media pictures and the school science. In the absence of formal teaching, it is normal that they cannot construct spontaneously explanatory systems at a scientific level. Therefore, one would expect that their erroneous conceptions are given up after formal teaching. However, several studies conducted in high school and in introductory university science courses, attest that at least some of conceptions identified among the pupils of 7 to 11 years still persist among students of upper levels [3, 4, 5]. Let's note that these studies also identified some false conceptions among students that may result from formal teaching per se. To foster the evolution of the spontaneous conceptions of these students toward scientific conceptions, some researchers propose educational strategies centered on the conceptual conflict, for example, to have pupils and students recognize the limits of their conceptions. If one doesn't proceed such as outlined before, as it is the case in traditional teaching, the spontaneous conceptions may resist teaching and will thus constitute an obstacle to science learning. The present research respects this orientation (i.e. constructivist approach) and thus has for object to uncover the conceptions of Preservice teachers with respect to the states of matter (solid, liquid and gas) and their transformations (liquefaction, solidification, fusion, etc.).

## 2. Methods

Eighty students of age 19 to 24 participated in this research in the context of a course on science teaching in a training program for primary school Preservice teachers. The majority of these teachers have a college diploma in liberal arts (two years of formation after the secondary school which lasts five years). In high school, they followed two science courses where they acquire some basic notions in physics, biology and chemistry. We have experimented with them a constructivist teaching approach to help them learn the physical transformations of matter. Let's note that the study of matter properties occupies an important place in the science curriculum designed by the ministry of the education of Quebec where the following notions are prescribed: the properties and the characteristics of the different states of matter (solid, liquid and gas), the water cycle, the density and the temperature. The experimentation took place in four sessions of three hours each per week and included the following steps: (1) answering a multiple choices questionnaire of sixty minutes duration to identify the conceptions of students about the transformations of matter before teaching; (2) confrontation of the conceptions of the students; (3) viewing an educational movie (Eureka! TVOntario, Canada) intended for pupils of 6 to 12 years about the notions of changes of states - molecule - heat and temperature - the Celsius thermometer. After viewing the movie, the students had to revise their answers to the questionnaire given in the introduction; (4) presentation by the teacher about the following notions: the physical transformations of matter (atomic and molecular aspects and the principle of conservation), temperature, heat, convection, etc.

## 3. Results

To identify the conceptions of the students after teaching, we have them answer a multiple choices questionnaire of sixty minutes duration that included eight questions (see annex). Each question was formulated as statement they had to answer true or false or to choose among a set of answers the one that is just according to them. In the two questioning formats, they have to justify their choices. This way of proceeding was put in place in order to know not only if they have learned the intended concepts but also to discover if they harbored any erroneous conceptions. Besides, the questions were formulated so that the student could not answer mechanically and therefore must draw upon his conceptual structure to answer them. For example, one of the statements of the questionnaire asked them to indicate if the following statement is true or false, while justifying their choice (*Question 1*): "When one transforms water, from the liquid to the solid state, the distances between the atom of oxygen and the two atoms of hydrogen that compose every molecule of water decrease". For 29 % of the Preservice teachers, this statement is true. However, for 30 %, the distances between the atoms those compose water increase. For these last ones, we present examples of their justifications: (1) "Water is an exception to the rule. When it becomes ice, its volume increases instead of decreasing, therefore the distance of the atom of oxygen and the two atoms of hydrogen's increases"; (2) "Water is one of the rare liquids that expands without increasing its mass ; it is only the atoms that expand and thus take more space. The links stretch out"; (3) "On the contrary, the atom of oxygen and the two atoms of hydrogen are going to move away from each other" and (4) "The distance between the atoms is going to stretch out, but without breaking". For 48 % of the students, this statement is false because it is the distance between the molecules that decreases. Only 23 % advanced a correct answer such as the distance between the molecules increases when water turns into ice.

Below for each of the questions 2, 3 4, 5, 6, 7, and 8, we present the percentage of the answers of the students and examples of their justification.

**Question 2:** When water turns into ice, the molecules are not anymore in movement and it is for this reason that the temperature of ice is equal to 0° C: [True - 14 %; False - 86 %]:

[**True**] "The temperature measures the level of agitation of the particles, therefore if the thermometer indicates 0 that is that there is no agitation of the molecules anymore". (E16)

[**False**] "The temperature measures the movement of the molecules. On the other hand, certain matter will go from the liquid state to the solid state at another temperature. It is therefore only a matter of reference. In fact, the molecules are always in movement. In the solid state of water, or ice, the molecules attract and repulse themselves, but in a very slow movement". (E3)

**Question 3:** Let's consider two identical glasses, one full of cold water and the other filled of hot water. There is: [(1) more water in the glass of cold water than in the glass of hot water (30 %); (2) as much water in the glass of cold water as in the glass of hot water (51 %); (3) less water in the glass of cold water than in the glass of hot water (19 %)]. Here are some examples of the justifications of the choices outlined above:

(1) "The molecules of water, the more they are heated, the more they distance themselves from one another, therefore they take more space. If we cool down hot water, its molecules are going to get closer and the level of water is going to diminish". (E5)

(2) "Whether the water is hot or cold, the variation of temperature doesn't have any influence on the quantity. In sciences, a byword states that: "Nothing gets lost; nothing creates itself, all changes".(E18)

(3) "There is less cold water than hot water in the identical glasses because there is more air in the cold water than in the hot water. The hot water has undergone the boiling point, therefore air left. If air in the hot water decreased and that we have two equal quantities, there are more places for the hot water in the glass". (E36)

**Question 4:** If one puts two identical glasses, one full of cold water and the other filled with hot water in a freezer. The two glasses: [(1) will freeze at the same time (7 %); (2) the glass filled with cold water will freeze before the glass filled with hot water (78 %); (3) the glass filled with cold water will freeze after the glass filled with hot water (14 %). Here are some examples of the justifications of the choices outlined above:

(1) "They will freeze but at the same time during change of state, the temperature doesn't change. That water is colder or hotter won't have any impact on the speed of the solidification". (E28)

(2) "The molecules of water of the glass filled with cold water already have a least agitation degree. They are going to reach the change of liquid state more quickly to solid state". (E32)

(3) "As the glass of cold water has more molecules to cool, I believe that it will be the hot water that will freeze in first". (E7)

**Question 5:** If one has two identical buckets, one full of hot air and the other filled with cold air. There are: [less atoms in the hot air bucket than in the cold air bucket (26 %); more atoms in the hot air bucket than in the cold air bucket (5 %); as many atoms in the hot air bucket than in the cold air bucket (69 %)]. Here are some examples of the justifications of the choices outlined above:

(1) "A hot gas takes more place than a cold gas. Therefore, for the same volume, there are less atoms of hot air than of cold air atoms." (E60)

(2) "Since in the hot air bucket, the atoms take more of space, in the opposite way, in the cold bucket, the atoms approach one another; therefore there will be less space ". (E18)

(3) It is the level of agitation of the atoms that influences the heat and not the quantity of atoms. The two buckets are identical". (E70)

**Question 6:** In winter, glasses cover themselves of moisture when one enters in a bus because of the humidity that "glues" on the glasses: [True (38 %); False (62 %)], Here are some examples of the justifications of the choices outlined above:

[True] "In winter, it is cold. When one enters in a bus, the glasses of our glasses are then very cold. In air, there is constantly water steam. When I enter in the bus, this water steam will come to glue itself to my glasses. The water steam is constituted of molecules that are very excited. Therefore, when they are going to enter in contact with my glasses, the molecules of which move very slowly because they are very cold, then the water molecules of in the air are going to slow down. Since they slow down, they will come back under the liquid state, what creates the moisture". (E48)

[False] "It is not about humidity. In winter, the outside is very cold, so the molecules of water don't move practically, they are frozen. Of this fact, when one enters in a bus, the molecules are agitated due to the ambient heat and ice takes its liquid state what causes the moisture in the glasses that were cold". (E17)

**Question 7:** All matter occupying a given volume and not having a definite shape is a matter that exists as [gas (42 %); Liquid: 56 %, Solid: 2 %]:

[Gaz] "All matter at the solid state possesses a volume and a definite shape. In the liquid state, a matter

takes the shape of the container that it occupies. In the gaseous state a matter possessing a given volume occupies the whole place available where it escapes". (E20)

[Liquid] "A solid has a definite shape, a ball is for example a solid and it has a spherical shape. Gas can be everywhere and therefore it doesn't have a precise volume. On the other hand, the liquid state doesn't have a definitive shape. It has a volume however, no matter where it is". (E66)

[Solid] "The molecules of a matter in the solid state are joined strongly and separated by a small distance. This is why matter occupies a given space". (E17)

**Question 8:** The closer the molecules are brought among them, their attraction force decreases and their freedom of movement increases (True: 4 %; False: 96 %):

[True] "The increase in the movement of a group of molecules augments their proximity due to the increase of their movement. This movement causes a reduction of the attraction force and the molecules have more space to move. On the other hand, their freedom of movement decreases when the molecules are brought closer". (E44)

[False] "Indeed, the molecules interact as if they were joined by springs. It could be said that they move away and continually come closer to each other. When their temperature decreases they come closer and their strength of attraction increases, making the "springs" even tenser. In this way, the more their strength of attraction increases, the more their liberty of movement decreases". (E12)

#### 4. Conclusion and implications

The results of our research demonstrate that it is possible to foster the evolution of the spontaneous conceptions of the students toward scientific conceptions. These same results demonstrate, on one hand, the resistance of the spontaneous conceptions to change and, on the other hand, the emergence of erroneous conceptions that results from teaching. Let's note that a teaching approach centered on conceptual conflict is difficult to apply considering the huge number of students in teacher training classroom and the constraints associated with the curriculum in the context of the formation of the primary teachers for whom, for the most part, the sciences are not part of their favorite subject!

#### Reference

- [1] D. Krnel, R. Watson and S. A. Glazar, The development of the concept of 'matter': a cross-age study of how children describe materials. *International Journal of Science Education*, 2005, 27, 3, p. 367-383.
- [2] J. Piaget and B. Inhelder, *The child's construction of quantities*, Routledge, London, 1974.
- [3] A. Métioui and L. Trudel, Preservice elementary teachers' conceptions of matter concepts: the case of physical transformations. In 10<sup>th</sup> European Conference on Research in Chemistry Education: Book of Abstracts, ECRICE, Pedagogical University of Krakow, Krakow, July 2010, p. 177-178.
- [4] A. Métioui and L. Trudel, Quebec Secondary Physics Teachers and the Modern Science: The Case of the Concept of Matter. *The International Journal of Science in Society*, 2012, 3, 1, p. 177-190.
- [5] A. Laugier and A. Dumon, The epistemological and didactical obstacles in the building of chemical element concept. *Didaskalia*, 2003, 22, p. 69-97.

#### ANNEX

**Question 1:** When one transforms water, of the liquid state to the strong state, the distances between the atom of oxygen and the two atoms of hydrogen that constitute every molecule of water increase :

True  False

Justify your choice:

**Question 2:** When water turns into ice, the molecules are not anymore in movement and it is for this reason that the temperature of ice is equal to 0°C.

True  False

Justify your choice:

**Question 3:** Let's consider two identical glasses, a full of cold water and the other filled of hot water:

- There is more water in the glass of cold water than in the glass of hot water
- There is as much water in the glass of cold water as in the glass of hot water.
- There is less water in the glass of cold water than in the glass of hot water

Justify your choice:

**Question 4:** If one puts two identical glasses, a full of cold water and the other filled of hot water in a freezer:

- The two glasses will freeze at the same time
- The glass filled of cold water will freeze before the glass filled of hot water
- The glass filled of cold water will freeze after the glass filled of hot water

Justify your choice:

**Question 5:** If one has two identical buckets, a full of hot air and the other filled of cold air

- There are less atoms in the hot air bucket than in the cold air bucket
- There are more atoms in the hot air bucket than in the cold air bucket
- There are as many atoms in the hot air bucket as in the cold air bucket

Justify your choice:

**Question 6:** In winter, glasses cover themselves of moisture when one enters in a bus because of the humidity that "glues" on the glasses.

- True                       False

Justify your choice:

**Question 7:** All matter occupying a given volume and not having a definite shape is a matter that exists as:

- Solid       Liquid       Gas

Justify your choice:

**Question 8:** The closer the molecules are brought among them, their attraction force decreases and their freedom of movement increases:

- True                       False

Justify your choice:

## The Pathway to Inquiry Based Science Teaching - Teacher Education at University

Nina WEGNER, Rüdiger TIEMANN

*Humboldt-Universität zu Berlin, Department of Chemistry, Chemistry Education,  
Brook-Taylor-Straße 2 12489 Berlin Germany  
nina.wegner@chemie.hu-berlin.de  
Tel.: 0049302093/7109 Fax: 0049302093/7482*

### Abstract

*The Pathway project founded by European Commission Seventh Framework aimed to demonstrate and disseminate methods and exemplary cases of effective introduction and implementation of inquiry to science classrooms and teacher professional development programmes. Embedded in the project's background we developed an open and a guided inquiry-based laboratory course. This intervention study has two purposes: one is to implement inquiry into teacher education at university level, and the second is to explore how future chemistry teachers' perspectives and understandings on the nature of scientific inquiry as well as their abilities to do scientific inquiry change in response to the received instruction (guided or open). The theoretical framework of the course, the description of conducted open and guided laboratory inquiry activities on the example of conductivity and developed assessment tools are presented in this paper.*

**Keywords:** Chemistry Education, Science Teacher Professional Development, Inquiry Teaching and Learning, Pathway Project (FP7)

### 1. Introduction

Following the recommendations of the Rocard Report [1] the pathway project as an European project founded by European Commission Seventh Framework is bringing together science educators, teachers, scientist, researchers, policy makers and curriculum developers to promote the effective widespread use of inquiry and problem based science teaching techniques in primary and secondary schools. The objectives of the project are to deliver a set of guidelines and to propose a standard-based approach to teach science by inquiry. Moreover, it is intended to reduce constraints of teachers and school organizations concerning this approach. For this reason, 25 partners across Europe and beyond intent to demonstrate and disseminate methods and exemplary cases of effective introduction of inquiry to science classrooms on the one hand and professional development programmes on the other hand [2,3].

In this article we describe our study which is embedded within the pathway project and its background. Inquiry-based science education emerged in the previous decade as a central goal of educational reform in Germany [4]. Thus chemistry teachers need to understand the nature of scientific inquiry in order to improve their students' understandings and abilities concerning scientific inquiry. These understandings influence the approach to chemistry teaching and even their teaching behavior. Teachers at science and education departments are responsible for their students' science knowledge and their understanding of scientific ways of thinking. They should also provide the student science teachers with information related to teaching and learning of these issues and make connections with applications to their future responsibilities in the classroom [5]. For these reasons our first priority was to establish a laboratory course on scientific inquiry into the student teacher education at university level. This course described in the following article is intended to help future science teachers to develop their own, deep understanding of inquiry so that they are prepared to implement inquiry and finally able to guide and organize students to conduct inquiry activities. The purpose of our accompanying intervention study is to evaluate the course's activities and to demonstrate the effectiveness focusing on the change of student teacher's views of scientific inquiry. In addition, we investigate the effect of different inquiry learning approaches (open/guided) on the participants learning outcomes and their ideas of scientific inquiry during this one term laboratory course.



## 2. Theoretical Background

Although there is a large body of literature concerning the term inquiry, it has been variously defined [6-8]. Minner et al. have underlined that inquiry refers to three categories of activities. They summarize “what scientists do” opposed to the category of “how students learn [9]”. It should be noted, however, that among these several usages of inquiry each one is fairly distinct from the other, even though literature also suggest clearly relationship between these forms of inquiry. Designing and using curricula that allow these kinds of investigations are excellent examples of the last category the “pedagogical approach that teachers employ [9]”.

### 2.1 Scientific Inquiry and Inquiry Learning as a learning aim

According to the National Science Education Standards scientific inquiry “refers to the diverse ways in which scientists study the natural world and propose explanations based on the evidence derived from their work [10].” This definition of inquiry offers insights into an understanding of how science proceeds and into certain abilities of reflection. In conclusion, this is independent of educational processes. Project 2061 emphasizes that scientific inquiry “is far more flexible than the rigid sequence of steps commonly depicted in textbooks as ‘the scientific method.’ It is much more than just ‘doing experiments,’ and it is not confined to laboratories [11].” The term inquiry is also used to describe learning activities according to a constructivist approach. Used in this manner students are engaged actively in the process of inquiry, in which they should develop “knowledge and understanding of scientific ideas, as well as an understanding of how scientists study the natural world”. It is particularly important, that inquiry learning is “something that students do, not something that is done to them [10]”. The NRC describes core components from the learner’s perspective as “essential features of classroom inquiry” [12]. In brief, inquiry learning includes students learning *through* inquiry, using skills employed by scientists such as raising questions, collecting data, reasoning, reviewing evidence, drawing conclusions and discussing results. Moreover, when students learn through inquiry they can develop scientific knowledge and they can also learn *about* inquiry, including the processes of science and how to construct reliable, valid and accurate investigations.

### 2.2 Inquiry as a teaching approach

Following the extensive literature concerning inquiry, there is little more consensus regarding what students should learn about scientific inquiry than how teachers should instruct students [7]. In line with the variety of definitions there is no single pedagogical approach or teaching strategy that teachers employ to foster inquiry learning in order to help students to learn about scientific inquiry, develop their abilities of inquiry and understand science concepts [13]. Each feature of classroom inquiry described above can vary in the amount of direction and decision-making predetermined by the teacher versus the amount of self-direction and decisions done by the students. Bucks et al. have suggested a rubric to characterize the type or level of inquiry in laboratory activities in order to propose a tool for identifying varying degrees of student independence [14]. On the basis of prior publications [e.g. 15-16] they distinguish between six characteristic activities (like problem/question, theory/background, procedures/design, results analysis, results communication) and five level of laboratory investigation (like confirmed, structured, guided, open and authentic inquiry) referring to different extent of provided guidance [14].

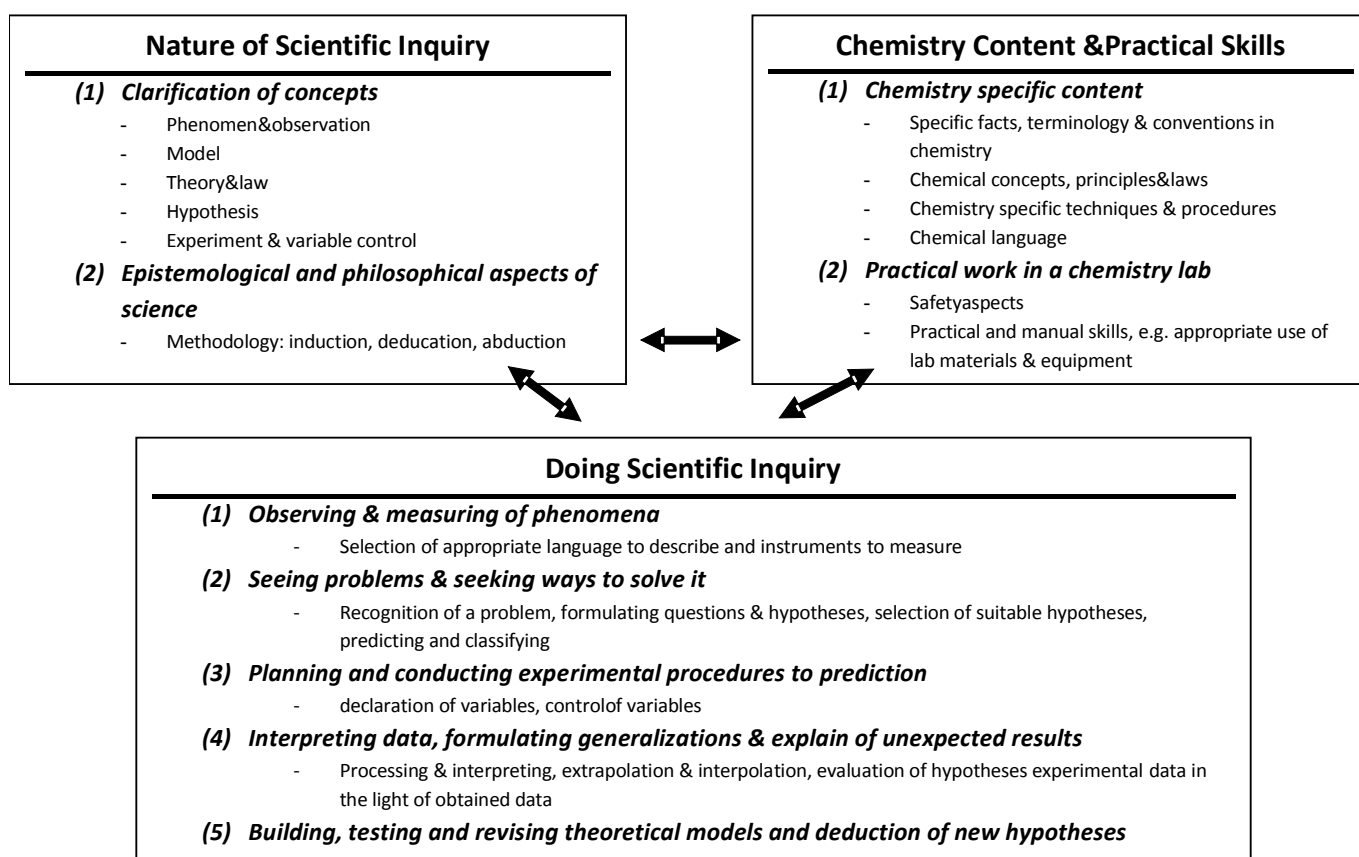
Due to the lack of a shared understanding of the defining features of various instructional approaches significant advancement determining effects of instructional guidance on the views and the understandings about scientific inquiry and the comparison of obtained results are difficult [17]. Here we go further previous results and provide a model of an open and guided intervention activity in the area of teacher education and teacher professional development. Therefore, we will present our conceptual framework of laboratory course on scientific inquiry. This was built upon the findings from reviewing several resources concerning inquiry instruction and forms the basis for the comparison of learning outcomes in response to the received instruction.

### 3. Design and Assessment Instruments

#### 3.1 Description of the Laboratory Course on Scientific Inquiry

Educating for an appropriate understanding of scientific inquiry entails not only doing scientific inquiry when dealing with different chemistry concepts but also learning about the nature of scientific inquiry. The course consists of characteristics illustrated in the following. Describing the general structure and organization we can firstly mention the duration. To improve professional development, it is important to focus on the duration of the professional development activity [18]. One-day workshops with little or no follow-up do not have a lasting impact on teaching practices [19]. Thus we impellent a long-term laboratory course with 14 week with 4-hour-couse. Concerning the level of instruction we differentiate between guided laboratory activities, initiated by theoretical driven lectures, presentations & discussions which are more structured and teacher led. On the other sight is the open laboratory inquiry course with a stronger focus on problem-based and discovery learning which is less structured by the teacher and more influenced by student guidance.

Figure 1 highlights the content structure of the developed course focusing on the area of knowledge about nature of scientific inquiry as well as on knowledge about doing scientific inquiry, knowledge about practical lab work and content knowledge while focusing on curriculum-oriented experiments and investigations.



**Figure 1** Structure and aimed knowledge areas of the laboratory course on scientific inquiry

The area of knowledge of scientific inquiry comprises ideas of epistemological and philosophical aspects concerning science. We focus on different aspects like methodology and scientific reasoning, conceptual clarification in term of scientific method. Methodological questions are reflected in the area of knowledge about doing scientific inquiry. It is important to emphasize, that the authors fully recognized of the fact that there is no “scientific method” per se knowing that sometimes not all listed scientific inquiry skills

will be used in any one investigation. On the other hand these knowledge areas have to be combined in order to apply individually skills of doing inquiry.

### 3.2 Description of an exemplary laboratory guided-inquiry versus open-inquiry activity

As the course is designed, additional questions arise concerning the different degree of guidance. Table 1 illustrates our distinction and defined characteristics of open and guided inquiry activities.

**Table 1** Characteristics of the guided and the open inquiry course

Characteristic	Level : Guided inquiry	Level : Open inquiry
Problem/Question	Provided	Provided
Theory/Background	Provided	Provided
Procedures/Design	Provided	Not provided
Results analysis	Not provided	Not provided
Results communication	Not provided	Not provided
Conclusions	Not provided	Not provided

As a result of this article we will now illustrate on the example of open and guided laboratory activity on the problem of conductivity what student teachers investigated. The guided laboratory course focused on the question of specific conductivity and its dependence on the kind of electrolyte. Participants investigated by measuring of different 0.5M solutions and arranged the following order:  $\text{HCl} > \text{NaOH} > \text{NaCl} \approx \text{KCl} > \text{CH}_3\text{COONa} > \text{CH}_3\text{COOH}$ . Data of the video analysis have shown that they spend a lot of effort on data analysis, interpretation as well as finding explanations and conclusions why strong acids and bases have significantly higher conductivities than their salts. For weak acids such as acetic acid and their salts, this is just the opposite. In contrary, the open inquiry course focused caused by the higher degree of participants self-direction different aspects. Table 2 lists, what was questioned and investigated using observations or experiments based on prior knowledge.

**Table 2** Formulated problems and questions concerning conductivity by the participants of the open inquiry course

- Questions concerned about how the conductivity may depend on the charge of the ions or of the size of the ions.
- Questions concerning how the velocity of the ions in aqueous solutions depends on of their "size" considering the concept of hydration shell.
- Questions about the very high conductivity of strong acids as well as approximately equal conductivities of 0.5 molar potassium chloride and sodium chloride solution, however, the acetic acid has a relatively low conductivity.
- Questions aiming at the precipitation which is accompanied with a minimum conductivity. They connect this minimum with the added amount of soluble salts (e.g. $\text{MgSO}_4$ $\text{BaCl}_2$ ) and the precipitated amount of the sparingly soluble salt.

Participants focused stronger on the recognition of the problem and clearly formulation of questions and corresponding hypothesis. They asked a bigger variety of high-order, more complex and unknown questions compared to the other group. But in the following they often showed difficulties in terms of planning and conducting their investigation. Especially, they had problems in defining and controlling of variables.

### 3.3 Assessment instruments

In line with the different models to determine the best of a professional development event for local contexts our following work will examine two different levels of evaluation [20]. First we investigated the participant's reactions and raise the question about the expectations formulated by pre-service teachers in terms of training? Yet another question of interest for us was how participants subjectively estimate their own learning success and progress. We conducted semi-structured interviews in the beginning and in the end of the course focusing on understandings and knowledge on the nature of scientific inquiry. We video documented all activities and conducted think aloud protocols of 12 participants while doing inquiry investigations in order to assess teacher students' knowledge about doing scientific inquiry.

### 4. Prospects including first results and conclusion

To conclude, we presented our theoretical-driven framework of a professional development course on scientific inquiry and developed assessment tools (interviews, video). First results of the preliminary study indicated, that the participants show different levels of skills and abilities in the beginning of the course. They mainly work without formulated research questions and hypotheses, show superficial understandings of planning own investigations (problems of identifying variables, control of variables) and use methods and apparatus not appropriate to their objectives and questions. In Addition, they often miss to document proceedings, data and results while conducting investigations.

### Bibliography

- [1] Michel Rocard et al., Science Education now: a renewed pedagogy for the future of Europe, European Communities. 2007.
- [2] Bogner, F.: Homepage of Pathway project. <http://www.pathway-project.eu>. Accessed 10 July 2012.
- [3] Wegner, N, Tiemann, R., The Pathway To Inquiry Based-Science Teaching. Jahrestagung der Gesellschaft der Didaktik der Chemie und Physik. Bd. 32, Oldenburg, September 2011, p. 604-606
- [4] KMK, Educational Standards in Chemistry at the End of grade 10, Berlin, 2004 [KMK 2004b (Hrsg.): Bildungsstandards im Fach Chemie für den Mittleren Schulabschluss. Berlin 2004]
- [5] Siebert, E., & McIntosh, W., College pathways to the science education standards, VA: NSTA Press, Arlington 2001.
- [6] American Association for the Advancement of Science (AAAS), Project 2061: Science for all Americans, Oxford University Press, New York 1990.
- [7] Anderson, R., Reforming Science Teaching: What research says about inquiry, *Journal of Science Teacher Education*, 2002, 13(1), 1-12.
- [8] Barrow, L. H., A Brief History of Inquiry: From Dewey to Standards. *Journal of Science Teacher Education*, 2006, 17(3), 265-278.
- [9] Minner, D.D., Levy, A. J., & Century, J., Inquiry-based science instruction - what is it and does it matter? Results from a research synthesis years 1984 to 2002, *Journal of Research in Science Teaching*, 2009, 47, 474-496.
- [10] National Research Council, The National Science Education Standards, National Academy Press, Washington DC 1996, p. 2, 9, 23.
- [11] American Association for the Advancement of Science, Benchmarks for Science Literacy, Oxford University Press, New York 1993, p. 9.
- [12] National Research Council, Inquiry and the National Science Education Standards: A guide for teaching and learning, The National Research Council, Washington D.C. 2000, p.25.
- [13] Bybee, R. W.: Teaching science as inquiry. In: J. Minstrell & E. H. van Zee (Eds.), *Inquiry into inquiry learning and teaching in science*, pp. 20-46. American Association for the Advancement of Science, Washington 2000.
- [14] Buck, L. B., Bretz, S. L., & Towns, M. H., Characterizing the Level of Inquiry in the Undergraduate Laboratory, *Journal of College Science Teaching*, 2008, XXXVIII(1), 52-58.
- [15] Schwab, J.J.: The teaching of science as enquiry. In: J.J. Schwab and P.F. Brandwein (eds.) *The teaching of science*, 3-103, MA: Harvard University Press Cambridge, 1962.
- [16] Herron, M.D., The nature of scientific enquiry, *School Review*, 1971, 79, 171-212.
- [17] Hmelo-Silver, C., Duncan, R., & Chinn, C.A. Scaffolding and achievement in problem-based and inquiry learning: A response to Kirschner, Sweller, and Clark (2006), *Educational Psychologist*, 2007, 42(2), 99-107.
- [18] Garet, M., Porter, A., Desimone, L., Birman, B., & Yoon, K. S. What makes professional development effective? Results for a national sample of teachers, *American Educational Research Journal*, 2001, 38(4), 915-945.
- [19] Sherman, R., Safford-Ramus, K., Hector-Mason, A., Condelli, L., Olinger, A., & Jani, N. An environmental scan of adult numeracy professional development initiatives and practices, American Institutes for Research, Washington, DC 2006.
- [20] Guskey, T. R., *Evaluating professional development*, CA: Corwin, Thousand Oaks 2000.

## Using Spectroscopy Experiments in Laboratory to Facilitate Learning in Chemistry Lecture

Anastasia WILSON, Timothy W. STEPHENS, William E. ACREE, Jr.

*Department of Chemistry, 1155 Union Circle #305070, University of North Texas, Denton, Texas, USA 76203-5017  
E-mail: anastasiawilson@my.unt.edu*

### Abstract

*Spectroscopy is a useful tool as an introductory learning model for general chemistry students. The interaction of light with matter enables students to gain a wide variety of information from excited molecules based on chemical theory. The goal of laboratory is to have visual experimental results that enable students to draw conclusions about chemical interactions on the qualitative and quantitative levels that enhance learning in lecture. Chemical experiments using spectroscopic methods enable students to immediately see trends of chemical absorption of light by varying concentrations of a chemical compound versus the level of absorption of light or through the interpretation of a generated spectrum of the molecule. Acree has developed a series of experiments for students in the Modern General Chemistry Laboratory manual for undergraduates at the University of North Texas that incorporate using computer technology as well as spectroscopy for the teaching laboratory. By integrating computer technology into the laboratory, chemical relationships can be immediately seen with linearity in classic chemical theory and spectroscopy. Students can then be introduced to calculations that determine chemical properties therefore encouraging higher learning. Since only little preparation time is needed, and immediate results are seen in the spectroscopy experiments based on absorption and transmittance measurements, the quick generation of spectra enables students to have a hands-on learning experience with a gross understanding of the chemical theory that in turn facilitates their understanding in lecture.*

**Key words:** ultraviolet- visible, fast scanning photodiode array, spectroscopy, Beer's Law

### 1. Introduction

Developing experimental tours utilizing new spectroscopy instrumentation is slowly being integrated into the general chemistry laboratory [1-5]. Electronic excitation of molecules is directly achieved by stimulation from a radiation source, yielding emission and absorption spectra. Spectroscopy comes in many forms, including ultraviolet, visible light, radio-frequency, microwave, gamma rays and x-rays [6]. Instrumentation such as atomic absorption spectroscopy (AAS), gas chromatography/mass spectrometry (GC/MS), and ultraviolet-visible absorption spectroscopy (UV/Vis) are currently being implemented in the modern general chemistry laboratory in a creative and innovative manner in order to cushion the higher level analytical, organic, and instrumental analysis courses. The introduction of modern instrumentation stimulates student interaction through visualization and data interpretation that thoroughly discuss properties of chemicals, and inspires students for future careers in chemistry [1-5, 7]. The laboratory setting has long since been analyzed where instructor led learning transitions to the inquiry based laboratory [8, 9, 10]. The need for instrumental quantitation and visual qualitative exposure, has increased due to students' various interpretations of lecture material in order to link the channels of memory from visual and audio to strongly implement new material [8]. Inquiry based laboratories allow students the opportunity to: consider their observations, question those observations, search the literature for answers, investigate new techniques, explain their findings, and predict results. Reflection of ideas within the laboratory setting is necessary for the student digestion of chemical concepts presented within the appropriate amount of time [10]. Incorporating modern technology and quick data acquisition techni-

ques for compound or atomic analysis allows the student to use time to draw conclusions and ask questions that lead them to the next step in a procedure. It has been shown that when students are participating actively, their scores in the corresponding lecture course increase [9]. An increase in allotted laboratory time allows for students to switch between analytical instruments and computer technology, allowing students to retain, assimilate, and reproduce results [11].

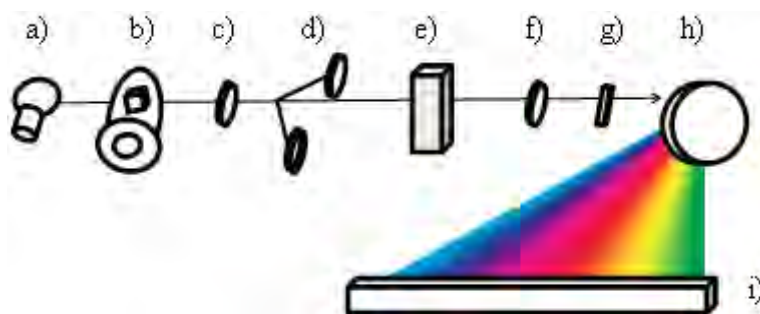
Utilizing chemical theory provided in lecture, visualization through an instrumental interpretation can yield a higher rate of success for students when real world applications exist and experiments are deemed exciting and motivating [12]. If students feel disconnected, disinterested, or are bored with a particular subject, students in their first year of college have been shown to change majors [2]. A series of experiments are outlined and incorporated into modern general chemistry labs to facilitate the learning of Beer's Law, chemical kinetics, quantification based on stoichiometric ratios and acid-base theory [1-5, 11]. A current look into facilitating (GC/MS) and (AAS) into laboratory is examined within the current literature. We present a creative and inquiry based (UV/Vis) experiment that is tested using a fast scanning photodiode array spectrophotometer comparing peaks in a spectrum of a mixture of two dyes in deionized water versus a single dye of similar color observed and concentration of corresponding chromophores.

### **1.1 Atomic Absorption Spectroscopy, Gas Chromatography Mass Spectrometry**

General chemistry students are introduced to the idea of matter in their first semester of their undergraduate career. (AAS) and (GC/MS) are excellent instruments for demonstrating many of the concepts taught in the corresponding lecture, including: the chemical theory of mass and matter, physical versus chemical changes, Beer's Law, isotopes, and heterogeneous versus homogeneous mixtures. New technological instrumentation (GC/MS) and (AAS) in the general chemistry laboratory have been explored [1-4]. (GC/MS) is integrated in general chemistry laboratory for organic structure determination to prepare students for organic chemistry. (GC/MS) is utilized to illustrate mass and quantification thereof, the use of internal standard applications, and isotopes [1]. Percent mass/atomic calculations are made with the help of (GC/MS) [3]. A simple synthesis lab, aspirin synthesis, has facilitated a series of instrumental analyses implemented for quantification and structure analysis. Differences of standard aspirin, salicylic acid, and the synthesized aspirin are found at University of Montevallo using (NMR), nuclear magnetic resonance, (FTIR), fourier transmission infrared radiation, (HPLC), high performance liquid chromatography, and (AAS) [2]. (AAS) is implemented as an introduction of the fundamental structure of the atom, electron count, atomic number, and mass number. Getting exposure to new technology would allow the possibility for better student participation since students have been shown to struggle with concepts associated with structure of the atom [13].

### **1.2 UV-Visible Absorption Spectroscopy**

Beginning laboratory an instructor led introduction to the fast scanning photodiode array spectrophotometer is given, detailing the instrument equipment, function, and analysis of samples. Figure 1 depicts a detailed fast scanning photodiode array with included parts constructed in Microsoft 2010. An introduction to calibration of the instrument is conducted as well as taking down wavelength absorption measurements. Absorbance regions within largest peak are peak maximum and determine the optimum wavelength absorbance measurements. The optimum wavelength helps determine concentration from Beer's Law where absorbance corresponds linearly. Before lab, questions are posed to students how many peaks will be seen, one or two observing, and if the mixture forming green color will be the same or different from standard green food dye.



**Figure 1** Fast scanning photodiode spectrophotometer: a) tungsten lamp, b) deuterium lamp, c) shutter stray light filter, d) source lens, e) cuvette, f) source lens, g) slit, h) grating, i) photodiode array.

## 2. Experimental Procedure

Three individual food dyes (blue, yellow, and green) and one mixture (blue + yellow) are examined, and the spectra are obtained from fast scanning photodiode array spectrophotometer. Students record, on separate sheets of paper, the four spectra seen for each food dye, and food dye mixture. Students label the optimum wavelengths. Absorption spectra were recorded from between 200 nm to 800 nm from the photodiode array. When starting the experimental analysis of absorbance versus concentration, to make the four solutions, the students add 2 drops of food dye to 30 mL of distilled water, for the mixture this is 1 drop of yellow and 1 drop of blue, which is a concentration of 1. Four dilutions are made by taking 10 mL of the concentration 1 solution and adding 10 mL of distilled water. This procedure is repeated three more times from each dilution. Absorbance readings from Pasco system are obtained at the concentrated solutions: 1, 0.5, 0.25, 0.125, and 0.0625. Students blank the instrument with DI water in a cuvette. The Pasco system, with colorimeter attachment, is limited to wavelengths between 468 nm to 660 nm but within the absorbance regions suitable for dyes. In these wavelength regions, incorporating the colorimeter; yellow food dye absorbance measurements are made at 468 nm, and 610 nm for blue food dye. Students make decisions within limitations of the instrument, what wavelengths are appropriate for each dye. Students write in essay format reasons for choosing specific wavelengths in the report sheet. Students construct a graph of absorption measurements against concentration values using computer technology. Students perform regression linear fit, observe chemical relationship based on theory, record line equation, and slope value equivalent to constant molar absorptivity coefficient for particular color, blue and yellow within the unknown mixture of green. Concentrations, of each from absorbance measurements within 5 mixtures, are found. No hazards exist for this experiment, but students need to wear eye protection and follow procedures specific to the university.

## 3. Results and Discussion

Experience has shown, when discussing in laboratory unique absorbance wavelengths represent each molecule according to structure to general chemistry students, the students become confused and cannot visualize the necessity of the type of chemical information. Once students have opportunity to visualize chemical relationships via laboratory instrumentation, students have opportunity to understand a lecture series. When utilizing the fast scanning photodiode array spectrophotometer, students acquire spectral information to formulate ideas from visualization. The students are able to see the green mixture in Figure 2, and the standard green food dye, Figure 3, exhibit prominent peaks found within the spectrum of the absorbing chromophores within the yellow and blue food dye. The peaks within the limitations of the Pasco system colorimeter are between wavelength regions 468 nm and 660 nm whereby two peaks are observed in this region that change in heights upon concentration differences of absorbing yellow, Figure 4, and blue, Figure 5.

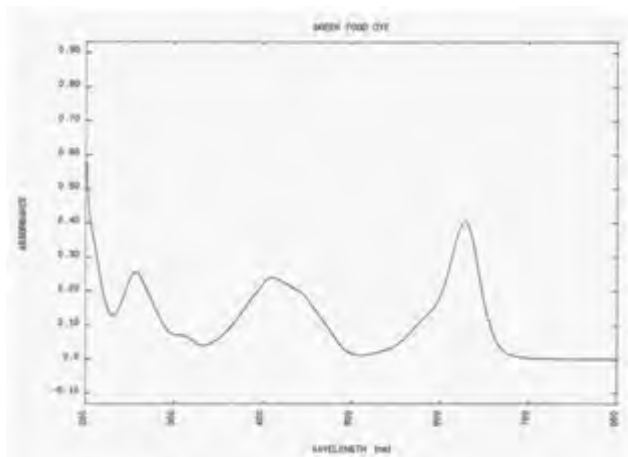


Figure 2 Green food dye absorbance regions

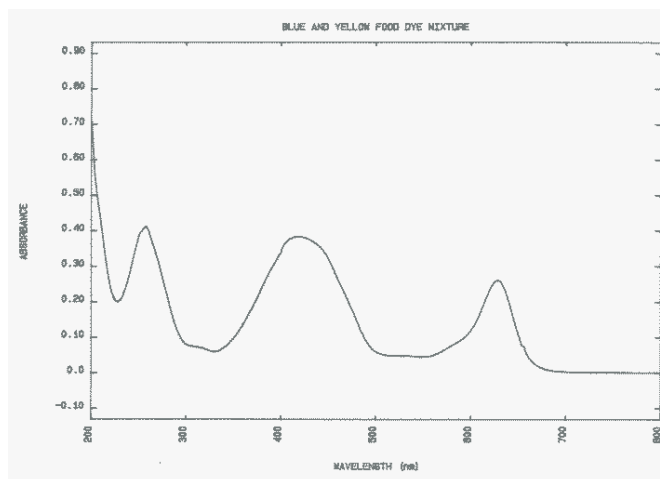


Figure 3 Mixture food dye absorbance regions

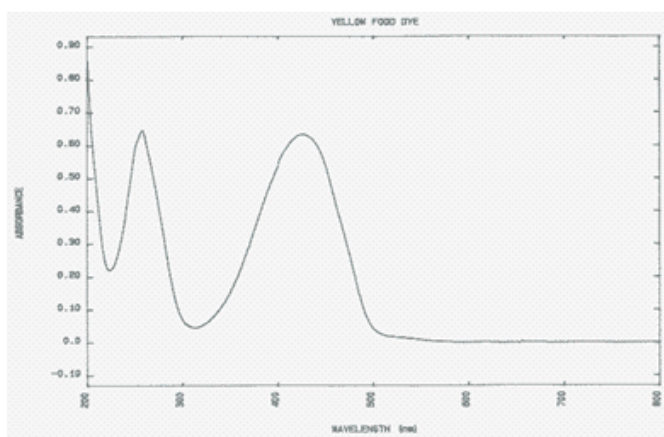


Figure 4 Yellow food dye absorbance regions

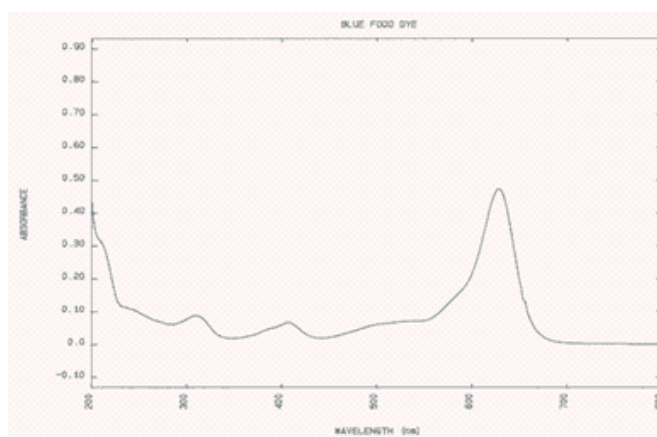


Figure 5 Blue food dye absorbance regions

Implementing the complementing computer Pasco colorimeter technology gives the students the motivation and excitement to understand separation chemistry, applications of spectroscopy, and laws relating molecules via regression analysis. The R squared values obtained for the regression of absorbance versus concentration for food dyes yellow, blue, yellow + blue in mixture, and green using the colorimeter are all  $> 0.9$  (wavelengths provided in experimental).

When measuring the intensity of light passing through a substance, and recording the level of absorption, students see mathematical relationships can be derived utilizing the colorimeter. A shortened version of the mathematical relationship in Equation 1 is given to students to understand the relationships as follows, where  $I_{tot}$  is the total amount of incident radiation,  $I_{abs}$  is the total amount of absorbed radiation,  $\epsilon$  is the molar absorptivity coefficient, or constant used to describe the system relationship at that wavelength in a particular solvent, and in this case the students used DI water. The path length of light,  $b$ , is indicated by the cuvette at 1 cm for this experiment.  $A$  is the absorbance at a single monochromatic radiation wavelength chosen [14].



$$-\log \frac{(I_{tot} - I_{abs})}{I_{tot}} = \epsilon bC$$

$$A = -\log \frac{(I_{tot} - I_{abs})}{I_{tot}}$$

$$A = \epsilon bC = -\log \frac{(I_{tot} - I_{abs})}{I_{tot}}$$

$$A = \epsilon bC$$

(1)

The color observed in dye is seen from visible light as a sum of colors transmitted through the dye. Absorption from each dye is specific for that dye and emits radiation in the form of an opposite color in the color spectrum since all colors of light are transmitted except the one color that is absorbed. Overlap between light absorption of color when light absorbing chromophores have more than one region of absorption or a region that covers a range of wavelengths in a Gaussian curve. The chromophore is the radiation absorbing species that is found in molar concentration of the sample indicated by . When molar concentrations exceed 0.01 molar, typically, nonlinearity results for the absorbing species in accordance with Beer's Law. If a solvent system has too low of chromophore concentrations and many conflicting ions in solution, a new molar absorptivity coefficient will be seen because of electrostatic interactions [11].

The Texas Academy of Mathematics students at the University of North Texas and the Upward Bound Mathematics and Science students working during the summer program find this experiment more exciting than food dye experiment without mixture and spectral analysis. Students find the lab exciting learning two instruments, the fast scanning photodiode array spectrophotometer, and the colorimeter that uses light emitting diodes that emit light in specific spectral regions in the form of a beam of radiation in the visible light range where the colorimeter attachment to the Pasco system functions similarly to a Spec 20 that is frequently used in research laboratories to determine solubility [6, 15]. The colorimeter, however, is limited to just four color wavelengths. Manipulation of the experiment for analytical labs utilizing the Pasco system for ease and affordability would be of consideration. Investigating zwitterion chromophores that change colors upon changing solvent systems is one modification [16]. As long as the color changes of the absorbing chromophores are able to absorb radiation from the four color wavelengths in the orange, green, blue, and red wavelength range, the experiment is sound [11].

### Literature Cited

1. Solow, M., *J. Chem. Educ.*, 2004, 81, 1172-1174.
2. Byrd, H., O'Donnell, S. E., *J. Chem. Educ.* 2003, 80, 174-176.
3. Pfennig, B. W., Schaefer, A. K., *J. Chem. Educ.*, 2011, 88, 970-974.
4. Liotta, L. J., James-Pederson, M. *J. Chem. Educ.*, 2008, 85, 832-833.
5. Klotz, E., Doyle, R., Gross, E., Mattson, B., *J. Chem. Educ.*, 2011, 88, 637-639.
6. Skoog, D. A., Holler, F. J., Crouch, S. R. *Principles of Instrumental Analysis*, 6<sup>th</sup> ed., Thomson Higher Education, CA, 2007.
7. Hofstein, A., Lunetta, V. N. *Sci. Ed.*, 2004, 88, 28-54.
8. Ealy, J. B., Hermanson, J., *J. Sci. Ed. and Tech.*, 2006, 15, 59-68.
9. Bobich, J. A. *J. Chem. Educ.*, 2008, 85, 234-236.
10. Pooch, J. R., Burke, K. A., Greenbowe T. J., Hand, B. M. *J. Chem. Educ.*, 2007, 84, 1371-1378.
11. Acree, W. E. Jr. *Modern General Chemistry Laboratory*, Eagle Images: Denton, TX, 2011.
12. MacNeil, J., Gess, S., Gray, M., McGuirk, M., McMullen, S. *J. Chem. Educ.* 2012, 114-116.
13. Suits, J. P., Hypolite, K. L. *Spectroscopy Letters* 2004, 37, 245-262.
14. Hirayama, S., Steer, R. P. *J. Chem. Educ.*, 2010, 87, 1344-1347.
15. Wilson, A., Tian, A., Chou, V., Quay, A. N., Acree, W. E. Jr., Abraham, M. H. *Physics and Chemistry of Liquids*, An International Journal, 2012, 50, 324-335.
16. Deng, T., Acree, W. E. Jr. *J. Chem. Educ.*, 1999, 76, 1555-1556.

## Self-Directed Learning in High School Chemistry Classes: A Case Study from Mainland China

Xiuyuan LIU, Feihong GUO, Qing WU

*The Affiliated High School of South China Normal University, Guangzhou, Guangdong 510630  
E-mail: liuxy@hsfz.net.cn*

### Abstract

*Self-directed learning has become one of the most important topics in today's educational reform. In this paper, we present a case study of three different chemistry classes on a specific topic – silicon, and evaluate the effectiveness of independent study in these classes. Furthermore, we put forward some ideas on efficient self-directed chemistry classes.*

**Key words:** self-directed learning, silicon , high school, chemistry class, China

### 1. Background Information

Self-directed learning is beneficial to students' lifelong learning and sustainable progresses. It has been recently emphasized by the chemistry curricular standards of high school in Mainland China. Self-directed learning has also drawn much attention from scientific educators, and it has become one of the most important topics in today's educational reform[1].

Three experienced high school chemistry teachers from three different cities in China were invited to the Affiliated High School of South China Normal University (HSFZ) to teach a self-directed class on the properties of silicon. Through comparing and evaluating the effectiveness of the three chemistry classes, this case study aims to investigate several practical issues related to self-directed learning in chemistry classroom, such as learning interest, self-directing methods, self-directing period, self-directing environment.

### 2. Comparison and analysis of the three case classes

#### 2.1 Design process of three case classes

**Table 1** The design process of three case classes

CASE No.	Brief Class Design
Case 1 ( Teacher A )	Preview: Showing the collection of silicon-relation items. Question: Silicon is both a main element in the crust and a major nonmetallic inorganic material. What is the relationship between these two roles? Activity 1: Study a fragment of optical fibers. Learn the chemical composition, basic properties, usage and source of the optical fibers. Activity 2: ① Study the silicon on computer chips. The teacher shows inside of the chip by knocking it with a hammer. Students observe silicon in a computer chip , summarize the physical and chemical properties of silicon. ② Experiment: Prepare silicon with silicon dioxide in lab The teacher and Students discuss on experiment method and experiment process. Students take the experiment on their own, explain and make conclusions. 2) The teacher and students review the experiment.

Case2 (Teacher B)	Preview: 1. play the song “the Tsing-hua Vase” (home-made MV by the teacher) 2. Create real-life scenario “Silicon and our Sunday”, leading to the main character of material-- silicon Part 1: Exhibit silicon chips. Show photographs of silicon and diamond. Compare physical and chemical properties of silicon and carbon. Part 2: Demonstrate the structures of diamond and graphite. Show the relationship between physical structures and properties. Compare silicon dioxide and carbon dioxide. Part 3: The reaction of $\text{SiO}_2$ and $\text{NaOH}$ and its application or prevention
Case 3 (Teacher C)	Preview (straight to the point): Silicon is the main character in inorganic non-metal material. Part 1: existence of silicon in nature Students fill in the study files, the teacher modify students' answers. Part 2: Structure and Properties of silicon dioxide Students fill in the study files referring to the reading materials. the teacher modify students' answers, and further explanation of $\text{SiO}_2$ chemical properties and applications, then play a game: paper that can't be burned and play the Video of glass etching with HF. Part 3: Silicic acid Students fill in the study files. Teacher and student analyze the principle, reagent and reaction equation together. Students prepare silicic with designed method; compare the acidity of acetic acid, silicic acid and hydrochloric acid.

## 2.2 Comparison and Analysis of the three cases

### 2.2.1 Learning interest

All three cases showed significant concern in arousing interest in students. Although different in many ways, they all used abundant pictures, samples and videos to visually excite students.

Case 1 focused on students' experience, such as the on-hand experience during the demon part. Teacher A not only demonstrated the fiber optic and chip samples, but also designed a set of active demons very attractive to the students, such as cutting the fiber, showing light-guiding of the optic fibers, finding silicon chips in disused CPUs. In a latter part, the teacher provided enough time for the students to experience the process of “produce silicon from sand”. Students were thrilled with the sense of achievement when they saw the silicon produced by themselves.

The key aspect of Case Class 2 was the presence of live scenario and the use of sample models. At the beginning of the class, Teacher B played the Jay Chao's pop song “Tsinghua Vase” and suggested students to appreciate the song with a chemical view. Then he used a dozen pictures to present the serial life scenario of “silicon and our Sunday”. Pictures showed in this part include skyscrapers, quartz clocks, and casseroles, which connected the Sunday life scenes together and were very much appealed to the students. At the end of the class, he demonstrated a pattern of the LOGO of the high school done by himself using sodium silicate solution. Students are strongly attracted to this beautiful gift.

The key characteristic of case class 3 lied in the design of the game. In order to better understand the use of sodium silicate as fire retardant, Teacher C and two students performed a magic show of “Inflammable and non-inflammable paper”.

### 2.2.2 Self-directing Methods

In case class 1, Teacher A implemented self-directed process via students' participation in experiment. Of course, the Self-directed learning is not completely unsupervised. At the beginning of the experiment, Teacher A fully discussed the experiment principle and procedures with the students. He also left some blanks for the students to ponder, for example, how to determine the product, how to analyze unusual phenomena, etc. The students were highly initiative throughout the experiment.

Case class 2 used a relatively traditional way of guiding and initiating to implement self-directed process. Each part of the teaching begins with the teacher's question, inspiration and conclusion. Teacher B first related the new and old knowledge comparing silicon with carbon. After setting up the method of compa-

risation and the idea of “structure determines properties” for the students, Teacher B used the method and idea further on comparing silicon dioxide and carbon dioxide with gradual inspiration.

Case Class 3 mainly used the way of filling study files to guide for independent study. Teacher C elaborately designed the study files and proceeded as “teacher leads in, students read, finish study files, analyze and make the conclusion”.

### **2.2.3 Self-directing period**

In case class 1 Students are sufficiently independent during the experiment. The time provided for self-directed process is concentrated and wide open. Students worked by themselves in groups to finish tasks including preparation of silicon, separation and purification of product, and examination of pure silicon. They also had the freedom to make use of time according to the situation. The teacher gave them enough patience and time for the students to think and work on the experiment. Almost all the students finished the experiment, which took about 20 minutes, or half the class period.

As for case class 2 and 3, the self-directed time periods are relatively spread. In case class 2, the teaching process consists of interactions between the teacher and students, reflecting the independence in the students' thinking process. The self-directed time is less obvious. Self-directed process in Case class 3 lied in the part of reading and filling in the study files, which affected the extent of independence and opening of the students in the process.

### **2.2.4 Self-directing psychological environment**

In case Class 1, the teacher satisfied the students' curiosity and the desire for exploration by setting a series of demonstration of samples and hands-on activities, ensuring the students' interest and excitement. All these things together made a harmonious, relaxing and cooperative class environment, which was very beneficial for implementing self-directed learning.

Teacher B from case class 2 is a teacher with good affinity and ability to guide students during the teaching process. When there was some deviation in students' answers, he was able to inspire and guide the student to see the correct answers. Therefore, the environment in the whole class was vigorous and smooth.

## **3. Some thoughts on self-directed chemistry classroom**

### **3.1 The level of independence**

The teachers of three teaching cases are all top-level teachers from north and south China, and the students are the ones from the best high schools in Guangdong Province. Therefore, the teachers or the students represent the best among their own group. Moreover, the content of the classes is about silicon, which is closely related to real life and is easier to practice self-directed teaching. Even so, the independence of the 3 cases is limited. As in case 1, there is only 20 minutes for complete independence. Therefore, it is impossible to make our classes completely independent. During the evaluation of the teaching, we cannot absolutely divide classrooms into “self-directed ones” and “not-self-directed ones”. Only when the level of independence, which is based on the understanding of such objective limitations, is improved, will it be meaningful and feasible to practice efficient Self-directed learning in class.

### **3.2 The precondition of self-directed classroom**

Only when students get the idea of active study and could remain in an positive and active state, can the self-directed study directed by the teacher be effective. Therefore, the precondition of the self-directed classroom is that teachers arouse students' interest in learning, stimulate their enthusiasm and enhance their confidence. Close and harmonious relations between teachers and students, charisma of teachers, humorous words and friendly smiles, strong encourage and positive teaching strategy (e.g. creation of various environments, close connection with social life) are all helpful to create a harmonious, relaxed and pleasant atmosphere for learning.

### 3.3 Important ways of self-directed classroom

Different ways to reach the goal of self-directed classroom are fundamentally the same. Teachers' demonstration and inspiration or students' reading, communication and discussion are feasible. However, since chemistry is a science based on experiments, hands-on experience in class is the most effective way in inspiring the students' independence. Self-directed learning focuses on the idea that students should be active, self-controlled and self-adjustable in the process of learning, which requires comparatively open space and time in addition to certain material and experimental conditions that help the students find and solve problems in the activities and experiments. As difficulty and failure is inevitable during the process of practicing, students need to check and evaluate their own study and adjust properly, in order to reach the goal of self-controlling and self-adjusting.

### 3.4 Guarantee of self-directed classroom

As the independence in self-directed classroom is a relative concept, teachers' guide is always necessary, no matter how the goal of independence is achieved. Teachers need to become "go-betweens", need to provide "scaffold" for students' thinking, need to offer necessary help to students' experiments, need to correct students' mistakes and they also need to lead the way of research. Teacher's effective guidance is the guarantee of self-directed classroom. Teacher's guidance should appear when students need it. The degree of guidance should adapt to the actual situation of students. For top students, a simple inspiration is enough, but for students who are weak in analysis, teachers need to provide more "scaffold".

### Acknowledgements

This research was supported by the Twelfth Five-year Program of Planning Topic of Teaching Research of Primary and Secondary School in Guangdong, China (Grant No. **J11-260**).

### References

1. Weiguo Pang, Self-directed learning: the principle and strategy of learning and teaching, East China Normal University Publishing House, 2003, 2-6

## Case Study on the Introduction of ICT into a Problem-finding and Problem-solving Oriented Chemistry Class

Takashi YASUOKA\* and Yoshika SEKINE\*\*

\* Institute for Learning and Teaching, Ritsumeikan University, 56-1 Toji-in Kitamachi, Kita-ku, Kyoto, 603-8577 Japan

\*\* Department of Chemistry, School of Science, Tokai University, 4-1-1 Kitakaname, Hiratsuka, Kanagawa, 259-1292 Japan  
e-mail; yasuoka@fc.ritsumei.ac.jp phone +81-75-466-3232

### Abstract

*Cultivation of a problem-finding and problem-solving potential of students has been a recent demand in the university class besides learning and understanding basic knowledge about a course. To have a question “why?” in students’ mind opens the door to the potential. We have previously reported that effect of incorporating “Question & Answer Corner” in our Chemistry courses on the improvement of student’s attitude. In the corner, students filled their own questions in a formatted sheet at the end of session and a teacher then answered to each question at the start of the next session. This Q&A Corner fully works in a small size class. In a large size class, however, only the limited number of questions can be answered in every class and most of questions have to be omitted. To solve this inconvenience, we have introduced the Discussion Corner in Web Course Tool as an alternative to the manual Q&A Corner in the spring semester of 2011. The effect was remarkable. In the case of Chemistry class consisting of 332 students, more than total 5600 queries and answers were uploaded on the site. In addition to that, the teacher became able to save time for answering question. By introducing the ICT-based discussions, 78 % of students answered that they have learned the importance of having questions and thinking.*

### 1. Introduction

The University of Phoenix (UPX) is one of the early pioneer and also one of the largest provider of online education, so called e-learning. In 1989, UPX started its on-line MBA program: students are clicking their way to an MBA using a computer and modem without ever setting foot on campus. However, use of e-learning has been forced to change its direction because the MBA distance education program did not pay for a decade despite the huge investment for calling students [1].

Lately, the e-learning style is widely used to hybrid with a traditional face-to-face learning. In particular, there is much demand for the style in the fields which require repeated exercises and many images for demonstration such as language and medical teachings. There are also many other merits for the introduction of ICT into teaching. For example, teachers become able care students in detail even after classes, and students are surprisingly positive to join a discussion in a virtual space.

It is very specific for Japanese students that they merely speak and/or make questions during a class. Therefore, there was a pilot study for promoting student’s reactions in a class via introducing the ICT [2].

Authors believe that a problem-finding and problem-solving potential is essentially required for students in all aspects of campus life and as well as of daily social life, and having a question “why?” in students’ mind opens the door to the potential. We have previously reported that effect of incorporating “Question & Answer Corner (Q&A Corner)” in the Chemistry class of 2009 on the improvement of student’s attitude [3]. In the corner, students filled their own questions in an A6 formatted sheet (named “Communication paper”) at the end of session and a teacher then answered to each question at the start of the next session. This Q&A Corner fully works in a small size class. In a large size class, however, only the limited number of questions can be answered in every class and most of questions have to be omitted. In this study, to solve the inconvenience, we have introduced the Discussion Corner in Web Course Tool in addition to the Q&A Corner in 2011 sessions.

## 2. Outline of the Chemistry course

The position of this course is a common program of Faculty of Science and Technology of Ritsumeikan University BiwakoKusatsu campus. The course title is Chemistry I. The outline described in the syllabus of 2011 spring semester was as follows.

**Aim and scope:** Chemistry is the science of matter. Since Chemistry is concerned with atoms and their interactions with other atoms, its chemical reactions, composition, structure and properties are major topics of the Chemistry class. In this class, you will particularly learn the states of matter and characteristics of changes in chemical systems in terms of laws and concepts of physics which are required for students in the science course. Latest topics relating to natural science will also be addressed.

**Schedule of this class:** Session 1: Guidance and History of Chemistry, Session 2: Nature of gases, Session 3: Atomic structure, Session 4-5: Chemical bonding, Session 6: The states of matter and solution, Session 7: The law of conservation of energy, Session 8: Chemical equilibrium, Session 9: Midterm examination, Session 10: Oxidation and reduction, electrochemistry, Session 11: Use of electrochemical cells, Session 12: Factors affecting the reaction rate, Session 13: Types of chemical reactions, Session 14: Nuclear chemistry-fundamentals, Session 15: Use of nuclear energy, electromagnetic waves.

**Evaluation of learning results:** Students will be evaluated on their performance in the end of semester written examination (40 points) and participation in class activities (60 points) including minute tests and assigned reports.

**Remarks:** Voluntary reports, which the student voluntarily finds a problem and submits, are also welcome. One point will be added to one voluntary report (upper limit of the point was set to 10 points). As well, 0.5 points will be given to each of question and answer submitted to the Discussion Corner in Web Course Tool(upper limit of the point was set to 15 points).

## 3. Practice of the course

Since this course is an ordinal chemistry class, the aim and scope are as like described above. For better understanding the chemistry, authors believe students should be able to find a problem and solve it by themselves. This problem-finding and problem-solving potential is essentially required for students not only in chemistry. Then, we tried to cultivate the problem-finding and problem-solving potentials in this class by sharing time for “Q&A Corner”.

As previously reported [3], we have adopted “Q&A Corner” in the 2009<sup>th</sup> Chemistry course. At the end of session, students filled their own questions in the Communication paper and the teacher(Prof. Yasuoka) then answered each question at the start of the next session. It should be noted that students can make any kinds of questions, even if they are not related to the class or chemistry. This means simple questions about student’s daily life are welcome. Releasing the framework made most of students possible to conceive ideas what they should raise as a question and write down. The teacher answered to about 1/4 of questions submitted from 133 students in every class. It took over 20 minutes to answer them. As a result of the repeated practices throughout the course, 60% of 133 students stated that they have learned the importance of having questions and have been surprised by knowing various interests and queries of their class mates.

In 2011, the number of students greatly increased to 332.If 90% of 332 students have submitted the questions, only the limited number of questions will be answered in every class and most of questions will be necessarily omitted. To solve this inconvenience, we have introduced the Discussion Corner in Web Course Tool in addition to the manual Q&A Corner. The Use of the Discussion Corner makes students to put their questions on the web site and ask the answers from other students. Students also have a chance to browse current concerns or queries of other students. As an incentive to students, 0.5 points were given to each of Q&A submitted to the Discussion Corner (upper limit of the point was set to 15 points) to encourage the discussions. Submission on the web corner was allowed for one week after the certain session. This was repeated for 14 sessions. The corner after one week was locked to prevent further submission and revisions, but open for browsing only.

Table 1 shows examples of student's question on the chemical bonding, which were written on the formatted sheet and discussed in the Q&A corner. Though questions 1, 14, 15, 17, 19, 27 and 29 were related to the class, most of questions were not related. In our experience, when we introduce the questions as "this is a query from Mr.○○, I'm going to answer his question now", students become concentrated to the lecture. So, this skill is very important to attract students. Questions which are not related the class tends to become diverse. So, the teacher has to study to find answers in about 5% of the questions. Some questions were sometimes difficult to answer, but the teacher was usually impressed by the various problem students found. Question 7 is about accidents in Fukushima Nuclear Power plant. There seems to be a potential fear for radioactive substances.

**Table 1** Examples of Questions about Chemical Bonding appeared in the Q&A corner.

Q1 What is the Covalent Compounds?
Q2 There are many kinds of radio waves emitted from TV or radio. Are they bad for human health?
Q3 Is there electron which has positive charges?
Q4 Why the snow looks white?
Q5 I see suspending sulfur in a hot spring. I know hydrogen sulfide is toxic. Does hydrogen sulfide generate from the hot spring?
Q6 In my childhood, I was told the muscle training suppressed the growth in height. I want to know the reason.
Q7 Does the radioactive substance influence on the fishes in the sea?
Q8 What is the antimatter?
Q9 When one can move faster than the light, one can go back to the past. Is it true? I can't sleep.
Q10 Tell me the principle of a refrigerator.
Q11 When we mix the red, green and blue of the watercolor, it becomes dark. In case of light, why it becomes white?
Q12 I heard the magnet loses its magnetic force when heated. Why?
Q13 Why does the atmospheric temperature decrease with height?
Q14 Mercury is a metal which are made by a strong metal bonding. Then, why the mercury is liquid?
Q15 How was the value of ionization energy measured?
Q16 Why the atomic bomb releases the massive heat and energy?
Q17 How is the chemical bonding connected to our daily life?
Q18 I do want to know the white powders in the fire extinguisher.
Q19 Is the van der Waals a name of scientist? When does the custom of naming scientists begin?
Q20 Principle of the touch panel.
Q21 Why does the aircraft fly?
Q22 Why the use of LED save the energy?
Q23 I would like to know the mechanism of muscular pain.
Q24 Is it true that CO <sub>2</sub> is a major cause of global warming?
Q25 What is the difference between Chemistry and Science?
Q26 It is generally accepted that green is good for eye. Why?
Q27 What is the octet rule?
Q28 What is the minus ion? How does it generate?
Q29 I can't understand the electron dot diagram of ozone.
Q30 Why the rubber band has elasticity?

During the 2011 semester, more than 5600 queries and answers were uploaded on the site. Table 2 demonstrates the discussions among students on the Discussion Corner in Web Course Tool. Early cases are related to chemistry, whilst later cases tend to be unrelated, and case 5 is about, say, "heaven". There are both types of students: who submit on the spur of the moment and who submit after investigating well.



**Table 2** Examples of discussions by students on the ICT-based Discussion Corner.

<p><b>Case 1 Theme: Teflon</b>            June 10 23:29, Contributor: SE            Is it true that Teflon used for frying pans or fabrics are carcinogenic?            June 11 09:05, Answerer: KY            Most suspicious material is PFOA (Perfluorooctanoic acid). Teflon is not PFOA. PFOA is used in the production process of Teflon and released from factories into air and water. The PFOA is carcinogenic.</p>
<p><b>Case 2 Theme: Ignition</b>            June 24 19:24, Contributor: SS            In TV or cinema, I often see drum and tank filled with gasoline catch fire when they are shot by guns. I have a simple question why they catch fire even though the bullet itself has no fire.            June 25 3:08, Answerer: AK            Friction or heat of a bullet ignites, doesn't it?            June 25 20:54, Answerer: KY            Only one shot is not enough to ignite. Friction or heat of a bullet does not ignite. Since an explosion includes a combustion process with a supersonic rate, it requires a combustion condition. The combustion requires oxygen. So, no combustion occurs in the tank filled with only gasoline, even when the tank is attacked by many shots. However, when the vaporized gasoline, which has leaked in advance or generated by the shock of shots, would pervade around the tank, the ignition could be triggered by sparks made by shots with metals or stones.</p>
<p><b>Case 3 Theme: Magnet</b>            July 13 23:31, Contributor: KS            Can we separate the N magnetic pole and S magnetic pole of a magnet body?            July 14 00:02, Answerer: YF            I heard the N and S poles exist as a pair.            July 14 01:34, Answerer: ST            Separating the poles simply produces two other magnets.            July 14 21:00, Answerer: TY            It is impossible to separate them. Even though there is no conclusive experimental evidence that magnetic monopoles exist at all in the universe, many scholars is trying to find the monopole which might be produced at a birth of the universe.</p>
<p><b>Case 4 Theme: Time machine</b>            May 9 11:14, Contributor: TT            I have many things to do by going back to the past. Is it impossible to develop the Time machine?            May 9 13:39, Answerer: YS            Basically, it is impossible because the time is not reversible. There is however a theory: if one can move faster than the light, one can go back to the past.            May 9 13:39, Answerer: TN            Sad to say, it has been already proved that it is impossible to go to the past.            May 9 15:39, Answerer: DM            Based on the Theory of Relativity, Einstein proved that the time travel is possible.            May 10 11:08, Answerer: TN            Please refer the following website which proves it is impossible.  <a href="http://www. . . . .">http://www. . . . .</a></p>

#### 4. Evaluation of the ICT introduction

In order to evaluate our trial to ICT introduction into the Chemistry course, we have included an additional questionnaire in the final written examination with a bonus of 10 points for students' incentive.

The questionnaire is “Describe what you have learned through 15 sessions”. The answers were evaluated following the criteria shown in Table 3.

**Table 3** Evaluation criteria for the additional questionnaire about this course in the 2011 final written examination.

Score	Criteria
10	In the students' answer, the following things should be written. He/she has learned not only a knowledge body of chemistry in this class, but also useful and practical things through Q&A corner. His/her life has been changed via this class, or He/she will apply the learned things to their life and/or other fields.
7	In the students' answer, the following thing should be written. He/she has learned not only a knowledge body of chemistry in this class, but also useful and practical things through Q&A corner. There are a few descriptions of the “changed” or “application” terms.
5	In the students' answer, the following thing should be written. He/she has learned not only a knowledge body of chemistry in this class, but also useful and practical things through Q&A corner.
3	In the students' answer, the following thing should be written. He/she has learned general principles from this course.
0	No answer or simply described that I have learned knowledge as a fact.

## 5. Results

Table 5 shows the results of evaluation of the additional questionnaire about this course in the 2011 final written examination. Before ICT introduction, average score was 4.7, whilst the score remarkably increased to 5.8 after the ICT introduction. Furthermore, the total percentage of the scores of 5, 7 and 10 increased to 78% from 58% via ICT introduction.

Another effect was also invited by the introduction of the ICT; the teacher successfully saved time for answering question in the Q&A corner. The answer time was reduced to 15 minutes in 2011 from 20 minutes in 2009. There was a claim on consuming time for answers in 2009, whilst no comment was found on the answer time in 2011.

This proves the effect of ICT introduction on the cultivation of problem-finding and problem-solving potentials, even when the number of students increased to 332 in 2011 from 130 in 2009.

**Table 4** Comparison of scores for the question\* before and after introduction of ICT

Score	Before (2009)		After (2011)	
	No. of Students	Percentage ( % )	No. of Students	Percentage ( % )
10	26	19.5	63	19.0
9				
8			3	0.9
7	4	3.0	91	27.4
6			1	0.3
5	47	35.3	102	30.7
4				
3	24	18.0	32	9.6
2	13	9.8	10	3.0
1				
0	19	14.3	30	9.0
Total	133	99.9	332	99.9

\*What did you learn through 15 sessions?

## 6. Validation of the evaluation and ICT effect

In order to validate the above evaluation, typical answers (three cases of score 10 and three cases of score 5) were shown in Table 6.

In answer 1, the student described he/she obtained a custom to note questions through the ICT-based discussion, Q&A in the class using the Communication paper and voluntary report, and also learned the importance of self-effort in problem-findings, investigating and solving-problems for his/her daily life. The student also recognized the obtained potential should be applied to further course of life, i.e. aiming for an engineer. So, this answer should be given score 10. The ICT effect was clearly found in this answer.

Answers 2 and 3 also meet score 10. The ICT effect was described too.

Answers 4,5 and 6 were given the score of 5. These cases clearly stated the importance of finding problems, so score 5 is reasonable for these answers.

**Table 6** Typical answers of the additional questionnaire about this course in the 2011 final written examination.

<p>Answer 1 (score 10)</p> <p>Through the 15 sessions of Chemistry I, I have noticed there are many questions in every place of our daily life. I have solved these questions using Discussion on the Web Course Tool, Communication Paper and Self-disciplined Report. By studying this class, I became to have a custom to note down my questions and strange things in daily life. So, I am always ready to do now. I have learned it is much important for living to find a certain problem, study the subject and find a solution by myself rather than the cramming of knowledge on Chemistry. I have also learned asking helps to someone who has enough knowledge on the matter as another way to solve the question, when I can't find the solution. I think the things I have learned in this class must be very important for me to live on and to drive for engineer. This class has only 15 sessions, but the things I have learned were much worthier than the ordinary 15 sessions. Thank you very much for your excellent instruction.</p>
<p>Answer 2 (score 10)</p> <p>Through this course I have obtained the following two things.</p> <p>The one is that most of my questions were solved. Prof. Yasuoka let us write our questions on the formatted-sheet and upload them on the Web course tool. Because Prof. Yasuoka kindly answered some of the questions at the start of every session, I could understand them at that instant. Furthermore, someone gave me answers to my uploaded questions on the web site, my worries disappeared. This is a very good system, indeed.</p> <p>Another one is that I became to have questions on the things going. Why it is like this? I have learned such attitude makes us possible to discover new valuable things in our life. I saw a positive act, instead of defensive, is necessary for my further life. Thank you very much, indeed.</p>
<p>Answer 3 (score 10)</p> <p>I have learned very important thing to become an engineer, this is my dream. I think the first step is very important in a research and field jobs. I have learned the importance of having a question - I must be able to do that to become an excellent engineer. I could not make original works without feeling something and finding problems. Of course, solving the problems, as well.</p> <p>In this Chemistry class, I surely made practices of them. This course actually made me grow up.</p> <p>In addition to them, I have noticed the importance of greetings. Greetings at the start and end the session made me remember my personal which I missed after entering the university. When I made greetings, I became tense and concentrated on the works.</p> <p>Anyway, I greatly appreciate Prof. Yasuoka, he told me very important things other than knowledge.</p> <p>I promise to make efforts to become an excellent member of society, thank you so much.</p>

## Answer 4 (score 5)

Through the 15 sessions, I have learned the importance to have a question of the daily happenings and things, and to explore the answers to the question by myself. I positively attended this class with a great interest, because I became able to know various concerns and questions of my class mates.

## Answer 5 (score 5)

Through the 15 sessions, I have learned the importance to have a question “Why?” and “How?”. I wrote many strange things, which I had had no concern before this class, on the Web CT and a communication paper. And, I had so many chance to have “Why?” by hearing my class mates’ questions. It was also amazing to investigate answers by myself and something that I could not find the answers of. I have obtained a custom; I investigate soon when I have a question.

## Answer 6 (score 5)

At first, I thought I have to memorize chemical formulas and calculate something. However, I was very happy to see the process why the thing goes on in this Chemistry course.

Through every class and discussion, I have recognized again it is very important to find questions in my daily life by watching various stuffs with care. I have found much more questions than expected. I hope not only to find the questions but also to solve them in my further life.

## 7. In lieu of conclusion

The Q&A Corner, a system in which students filled their own questions in a formatted sheet at the end of session and a teacher then answered to each question at the start of the next session, was proved effective to promote students’ attitude to the problem-finding and problem-solving. However, this system did not work well in a large scale class by consuming time for answering the limited number of students’ questions. To solve this inconvenience, we introduced the Discussion Corner in Web Course Tool in addition to the previous Q&A Corner and proved the ICT-based discussions successfully worked for the promotion with saving time in the session. By introducing such ICT-based discussions, 78 % of students answered that they have learned the importance of having questions and thinking.

## References

- 1) A. Yoshida, IDE Gendai no KotoKyouiku, 2002, 440,22
- 2) K. Endo, Journal of the educational application of information and communication technologies,2011,14(1),11-15
- 3) T. Yasuoka, Ritsumeikan Higher Educational Studies, 2-10, 10,203-216

## Predicting success of freshmen in chemistry

Katja FREYER<sup>a,\*</sup>, Matthias EPPLE<sup>b</sup> and Elke SUMFLETH<sup>a</sup>

*a) University of Duisburg-Essen, Institute of Chemistry Education, Schuetzenbahn 70, 45127 Essen, Germany.*

*b) University of Duisburg-Essen, Institute of Inorganic Chemistry, Universitaetsstr. 5 – 7, 45117 Essen, Germany.*

*\*Correspondence to: Katja Freyer, e-mail: Katja.Freyer@uni-due.de.*

**Abstract:** It is generally known that student success in chemistry is rather low. Approximately one fourth of freshmen will not succeed the course in general chemistry that is offered in the first semester of studies. Regarding the entire course of university studies - from the first through the last semester - this low student success is also reflected in dropout rates, since approximately every third student ends their studies before completion. This study investigates the qualification first-semester students in chemistry of different German universities at the very beginning of their studies. To do this, questionnaires have been developed to determine the students' attitudes towards their studies, their cognitive abilities, and their subject-specific qualifications. At the end of the first semester, results from the final exam were obtained. With the help of multiple linear regression, student success, defined as score in the final exam, has been predicted. The grade from secondary school graduation certificate, pre-knowledge, desired subject and university have been found to be the most important predictors for chemistry students. The comparison of the German universities shows meaningful differences. Between 22 % and 42 % of variance could be explained.

**Keywords:** Chemistry, higher education, freshmen, prediction of success, multiple linear regression analysis

### INTRODUCTION

The rate of German university students dropping out of chemistry without changing to another subject amounts to 31 % [1]. Most students leave university due to difficulties in performance and lack of motivation [1] caused by false expectations of their studies [2]. The highest dropout rates in natural sciences studies are found during the first semesters at university [2] since the beginning of studies is accompanied by a great number of problems, like adjusting to a new environment and social challenges that have to be managed all at once [3].

This dropout rate problem is not specific to Germany: Other European countries have excessively high dropout rates as well. Ulriksen, Møller Madsen and Holmegaard [4] state that around one third of students end up their studies before the scheduled time. Low student success is an important issue at American universities as well, as only approximately 70 % of freshmen in chemistry pass the final exam in general chemistry at the end of first semester [5-6].

In order to gain a better understanding of student success, it is necessary to find factors that, as soon as studies begin, are able to predict success. There have been a lot of approaches for determining the factors leading there. The attempts date back to 1921 [7]. Up to now, several variables predicting success have been identified. But only few studies deal with the prediction of student success in chemistry at German universities. This project aims at filling this gap.

Here, student success is defined as the score in the final chemistry examination at the end of first semester. For the prediction, a regression model has been built up on the basis of Schiefele, Krapp and Winteler [8] who state that usually three pieces are used in predicting academic achievement: cognitive factors, motivational factors and interest.

As first predictor pre-knowledge has been included into the model, because pre-knowledge is the precondition for accumulating further knowledge [9] and therefore also the basis for learning growth, which is finally measured by the exam at the end of the first semester. It is known that the predictive strength of pre-knowledge increases with rising consistency of test and study content [10]. Then, as cognitive factors,

two variables are added to the regression model: grade in secondary school graduation certificate (*Abitur*) and ability in deductive thinking. The highest predictive strength as a single predictor has been attributed to the grade in secondary school graduation certificate (*Abitur*). But in contrast to pre-knowledge, it is a measure for the general domain- *unspecific* study ability. Furthermore, abilities in deductive thinking are seen as central factors in measuring cognitive abilities, which show medium or satisfactory predictive strength [10]. As motivational factor the predictor *desired subject* is used. This variable contains one item that asks the students if they would rather study another subject. The next part of the model is subject interest. Here, ambiguous information can be found. Some studies show no predictive strength [11] whereas others find it meaningful [12-13]. Possibly, the positive effect of interest on student success evolves only after a longer time of studying [14].

Since students from different universities and different courses of study have been surveyed, these two variables are also included into the model. It is well-known that different study structures and requirements have an influence on student success as well [15-16].

## STUDY DESIGN

In winter semester 2011/12 freshmen in chemistry from different German universities have been surveyed at the very beginning of the semester (pre-test) and the end of the semester (post-test) on their knowledge, abilities, and attitudes they bring to university. Additionally, score in the final exam at the end of first semester could be obtained.

### Participants

A number of 459 students of the two courses of study *chemistry* and *chemistry education* can be included in the regression analyses. Their distribution over the three universities A, B and C is given in table 1.

**Table 1.** Participants divided by course of study and university.

	University A	University B	University C	Total
Chemistry students	88	63	180	331
Education students	29	31	68	128
Total	117	94	248	459

Female students (43 %) are a little less present in the sample than male students (57 %). There are also some differences concerning the students' year of receiving their secondary school graduation certificate (*Abitur*). Sixty-nine percent did their final exam just before starting their studies in 2011; 20 % one year before in 2010 and 11 % earlier than that.

### Material

The predictors are surveyed by a couple of questionnaires and items, respectively. Pre-knowledge is assessed by a *Chemistry Knowledge Test*, which consists of multiple-choice items and has been self-constructed on the basis of the lecture on general chemistry offered for first semester students in chemistry at the University of Duisburg-Essen. The *Test for Measuring Deductive Thinking* is taken from Wilhelm, Schroeders and Schipolowski [17]. Only the visual part has been used. For assessing subject interest, a questionnaire on study interest [18] has been adapted. This self-constructed test contains 11 chemistry-related items, like: *I'm studying this subject because engagement in chemical topics and matters is important to me*. For responding to the questionnaire on subject interest, a four-point Likert scale is given for specifying one's level of agreement. For the variable *desired subject* the following item has been used: *I would rather study a different subject*. Students could answer with *yes* or *no*. Grade in secondary school graduation certificate (*Abitur*), course of study and university have been asked for with one item each. Validity and reliability for all questionnaires could be proven in the frame of a pilot study conducted one year before in winter semester 2010/11.

Additionally, scores on the final exam in chemistry at the end of the first semester have been gathered. Since the students from the different courses of study and universities wrote different exams, scores have been z-standardized for regression analyses.

## RESULTS AND DISCUSSION

The results of the regression analyses for chemistry students are shown in Table 2. The predictors have been added blockwise and by the enter method. The values shown are the regression coefficients  $\beta$  of only the significant predictors ( $p < .05$ ).  $\beta$  is a measure of the predictive strength of a predictor. It describes the size of the effect of each predictor on student success.

Only one similarity can be observed: All universities have the grade in secondary school graduation certificate (*Abitur*) as predictor in common. But the extent of the influence on score in the exam differs. The comparably low effect for University C can be explained by the fact that those students had to pass a placement test in the frame of enrollment at this university. Since their grade in secondary school graduation certificate (*Abitur*) played an important role in this test, there is less heterogeneity in grades among the students and hence less influence on student success since the distribution of grades is less broad.

Whereas for University B there are no further predictors, for University A and C desired subject and pre-knowledge, respectively, show a significant influence on student success. The students of University C show the highest learning growth from pre- to post-test (data not shown here). They started moderately, but reached a significantly higher score in the chemistry knowledge test at the end of first semester than the students from the other universities. This fact could be a hint for the significant effect of pre-knowledge on the score in the exam.

The explained variance ( $R^2$ ) is also very different for the three universities. Over 40 % can be explained for University A, mainly by grade in secondary school graduation certificate (*Abitur*) and desired subject. But only about half as much can be explained for University C by the most important predictors pre-knowledge and also grade in secondary school graduation certificate (*Abitur*).

**Table 2.** Results of regression analyses for predicting success –  $\beta$ -coefficients.

	Uni A	Uni B	Uni C	All
Pre-knowledge	---	---	.348	.196
Cogn. A. <i>Grade (Abitur)</i>	-.512	-.415	-.337	-.452
<i>Deduct. Think.</i>	---	---	---	---
Desired subject	-.244	---	---	-.138
Subject interest	---	---	---	---
University <sup>1</sup> <i>Uni A</i>	---	---	---	.118
<i>Uni B</i>	---	---	---	.149
$R^2/\%$ [incl. university]	41.6	30.8	22.7	25.2 [27.1]

<sup>1</sup> Dummy-coded

One further reason for the differences between universities can be seen in the different study conditions at those universities. Study regulations have been compared as well (data not shown here), and meaningful differences could be found there. What can be seen in the model over all chemistry students in table 2, is that the predictor *university*, which is a measure for the conditions and regulations at each university, is significant. This finding shows that study conditions do have an important influence on student success, but it cannot be said where exactly the differences emerge from.

Further analyses on the differences between the universities will be done in future work.

## REFERENCES

- [1] U. Heublein, C. Hutzsch, J. Schreiber, D. Sommer, G. Besuch, HIS GmbH Hannover 2010.
- [2] U. Heublein, H. Spangenberg, D. Sommer, HIS GmbH Hannover 2003.
- [3] H. Gerdes, B. Mallinckrodt, J. Counsel. Develop., 1994, 72, 281.
- [4] L. Ulriksen, L. Møller Madsen, H. Holmegaard, Stud. Sci. Educ., 2010, 46, 209.
- [5] M. J. Legg, J. C. Legg, T. J. Greenbowe, J. Chem. Educ., 2001, 78, 1117.
- [6] C. McFate, J. Olmsted, J. Chem. Educ., 1999, 76, 562.
- [7] S. R. Powers, Sch. Sci. Math., 1921, 21, 366.
- [8] U. Schiefele, A. Krapp, A. Winteler: Interest as a Predictor of Academic Achievement: A Meta-Analysis of Research. In: K. A. Renninger, S. Hidi & A. Krapp (eds.) The Role of Interest in Learning and Development, pp. 183-212. LEA, Hillsdale [u.a.], 1992.
- [9] W. Schneider, J. Körkel, F. E. Weinert: Expert Knowledge, General Abilities, and Text Processing. In: W. Schneider, F. E. Weinert (eds.) Interactions among aptitudes, strategies, and knowledge in cognitive performance, pp. 235-251. Springer: New York, 1990.
- [10] C. Heine, K. Briedis, H.-J. Didi, K. Haase, G. Trost, HIS GmbH Hannover 2006.
- [11] A. Gold, E. Souvignier, Z. Entw.-psychol. Pädag. Psychol., 2005, 37, 214.
- [12] F. Fellenberg, B. Hannover, Z. Theorie Praxis erzieh.-wiss. Forsch., 2006, 20, 381.
- [13] H. Giesen, A. Gold, A. Hummer, R. Jansen, Prognose des Studienerfolgs. Ergebnisse aus Längsschnittuntersuchungen. Institut für Pädagogische Psychologie, Frankfurt a. M. 1986.
- [14] A. Krapp: *Interesse und Studium*. In: H. Gruber & A. Renkl (eds.) Wege zum Können: Determinanten des Kompetenzerwerbs, pp. 45-58. Verlag Hans Huber, Bern, 1997.
- [15] H. Moosbrugger, J. Hartig, Zur Bedeutung von individuellen und institutionellen Studienbedingungen für die vergleichende Evaluation der Lehre. In: U. Engel (eds.), Hochschul-Ranking, pp. 49-60. Campus-Verlag, Frankfurt [u.a.], 2001.
- [16] U. Preuss-Lausitz, I. N. Sommerkorn, Z. Erzieh. Gesell., 1968, 8, 434.
- [17] O. Wilhelm, U. Schroeders, S. Schipolowski, BEFKI. Berliner Test zur Erfassung fluider und kristalliner Intelligenz [Berlin test of fluid and crystallized intelligence]. Unpublished manuscript, 2009.
- [18] U. Schiefele, A. Krapp, K. Wild, A. Winteler, Diagnostica, 1993, 39, 335.



## The continuity between the lab work and the post lab session. The Influence on Learning: Progress of Reaction via ICT

Rita KHANFOUR-ARMALÉ

LDAR, Université de Cergy Pontoise, IUFM d'Antony  
LDAR, UFR de Physique, Condorcet building, Rooms 846A and 847A, .  
10 rue Alice Domon et Léonie Duquet, Paris, 13e arr.  
E-mail: rita\_armale@yahoo.com  
Tel: 0033157276034 and fax: 0033157276031

### Abstract

*Teaching and learning of chemistry have long been studied and a large share of the research on this topic has used chemical reactions as a context. Many points of view have been studied such as teaching the notion of chemical reaction, and specifically student conceptions or their difficulties in understanding this notion. However, understanding chemical reaction is difficult because it involves the notion of substance under transformation. A teaching sequence involving ICT that uses an animation aiming to present a sub-microscopic aspect of the progress of reaction was employed. We focused on teacher activities for structuring student knowledge after this laboratory work. Our research aimed to compare knowledge embedded in the student's activity (lab work) and knowledge that the teacher structured when s/he comes back to review student work in the post lab session that we called Debriefing. Two teachers and their students were videotaped. The videos were extensively transcribed and analyzed from the facet point of view where sensitive concepts were involved. Results led us to characterize the continuity of the knowledge used during a teaching sequence on the basis of the number of facets that the student's activity and the debriefing have in common. Two cases were observed. Both teachers reviewed his/her student's activity using the concepts embedded in the activity. For one of them, it was reviewed within the same context as the experimental situations. For the second one, this was not the case. New information was added to the definition of the debriefing and the notion of the limit of the debriefing was introduced.*

**Keywords:** lab work, post lab session, ICT, teacher practices, progress of reaction, knowledge.

### 1-Introduction

Teaching and learning of chemistry have long been studied and a large share of the research on this topic has used chemical reactions as a context. Many points of view have been studied such as teaching the notion of chemical reaction (Gabel, 1998), and specifically student conceptions (Driver & al., 1985, Andersson, 1986-a, 1990; Hesse & Anderson, 1992 ; Nakhleh, 1992 ; Taber, 1998) or their difficulties in understanding this notion (Stavridou & Solomonidou, 2000; Cros & al. 1994 ; Gussarsky & Gorodetsky, 1990). However, understanding chemical reaction is difficult because it involves the notion of substance under transformation.

### 2-Aims and objectives

We have supposed that having a dynamic representation of what happens at the sub-microscopic state during a chemical reaction would help students to develop a useful mental representation and to have a logical path between the initial and final states of chemical transformations. A teaching sequence involving ICT that uses an animation (Figure 1) aiming to present a sub-microscopic aspect of the progress of reaction was employed (Le Maréchal & al., in progress). The teaching sequence is organized in three main parts. The first part leaves time for students to observe the animation but no real issues conceptual delicate are addressed. The second part was a quantitative exploitation of the animated window from observing the evolution of the number of each particle. Finally, the third part presents an exercise to revisit concepts acquired without the world of simulation.

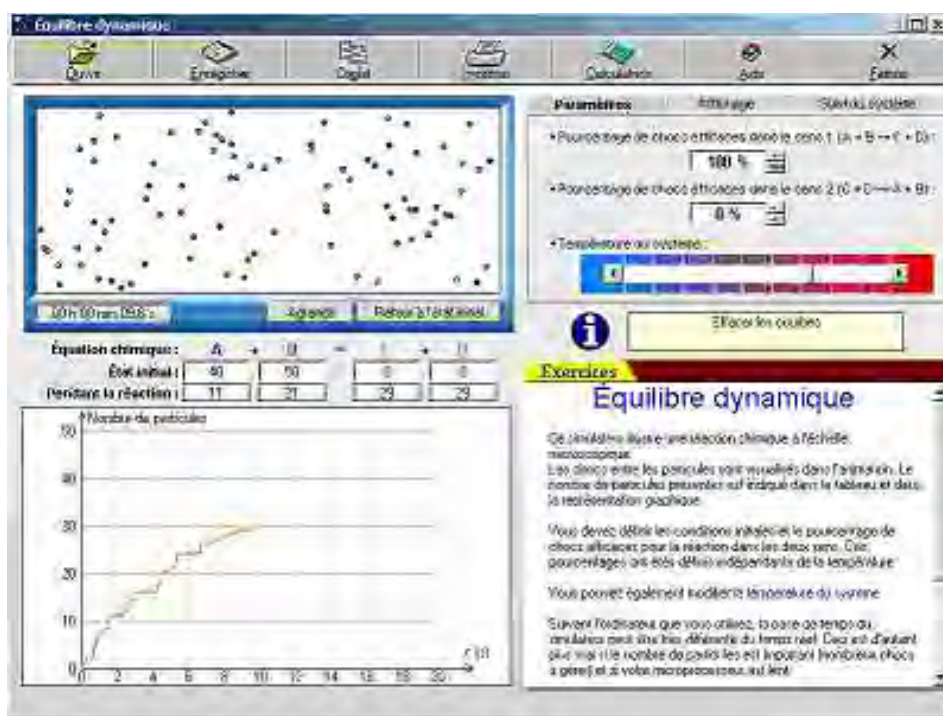


Figure 1: Main windows of the simulator

Our research aims to compare knowledge embedded in the student's activity (lab work) and knowledge that the teacher structures when s/he comes back to review student work in the postlab session that we called Debriefing (Khanfour-Armalé & Le Maréchal, 2009).

### 3-Methodology and results

#### 3.1-Data

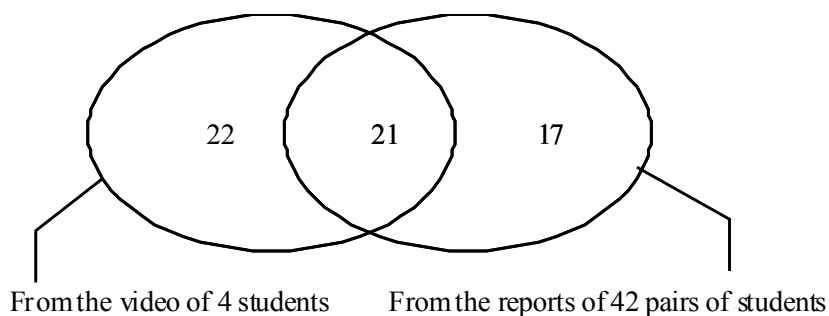
MC and HB, used this task for two years with their classes and we collected data during this two years. 42 reports corresponding to 84 students were analyzed, and four pairs of MC's students were video taped. The students were very autonomous, with their teachers standing back while they used the computers, checking student work progress, interfering only in case of need. MC and HB were video taped during their debriefing (post lab sessions). The students and teachers' videos were extensively transcribed and analyzed from the facet point of view.

#### 3.2-Facets Analysis

The teaching sequence presented below involves sensitive concepts (several chemical concepts) that are the target of learning, among them: particles, collision between particles, reactive collisions and extent of reaction. Each of these concepts involves a large amount of knowledge that many students do not master even at university level. Evaluating their learning at the 10th grade is therefore a real question. A detailed analysis of knowledge is necessary to assess how this learning occurs during a teaching sequence. The notion of facet of knowledge (Minstrell, 1992) was found appropriate to address this issue. Using facets corresponds to a decomposition of knowledge into small units that allows knowledge from different origins to be compared. Methodologically, it is interesting to have a tool that can allow us to compare the knowledge involved during a task done either by two people, or by a given student at different points of his/her learning (Minstrell, 1992). A second key aspect of facets is their constitution. Facets of knowledge are very close to students' utterances. There needs to be only minor reconstruction by the researcher to decontextualise the students' words and transform them into a facet that must contain a more global idea. We used the notion of facets for students and teachers words. For example, if students talk about simulated particles that change color when they collide, they may say: "the pink one becomes orange and

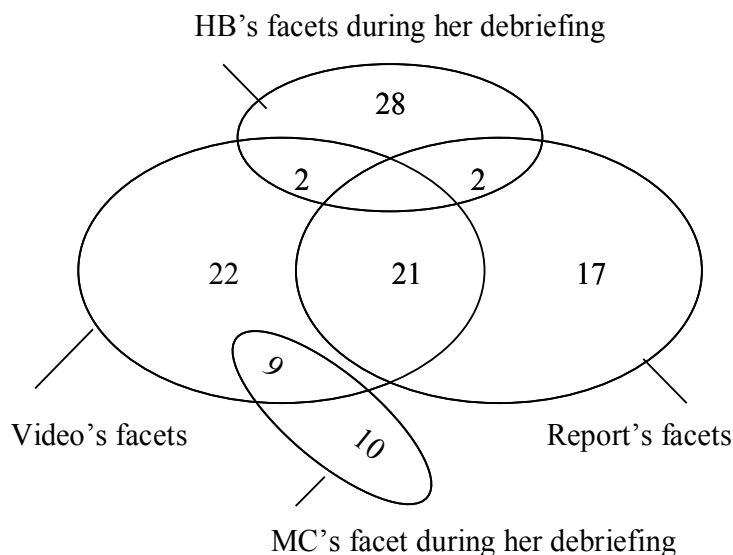
the blue one becomes green”. The corresponding facet will be: Particles change their color and particles touch each other or collide.

A list of 43 facets of knowledge was established from the interactions of both pairs of students. In addition, the analysis of the 42 reports of student pairs from both teachers led to 38 facets. In these 38 facets, 21 were already part of the list of 43. The 17 remaining facets were new ones. The  $43 + 17 = 60$  facets make up a reference list for this work (figure 2). Most of these facets were in agreement with the *a priori* analysis of the work assigned to the students. Although having other students doing the same work in the same conditions may extend this reference list, we hypothesized that this corpus of facets is representative of this work.



**Figure 2:** Origin of the 60 facets of the reference list

The debriefings of both teachers were organized as a class discussion based on the text of the work as it was given to the students. Both teachers dominated the discussions. MC used 19 facets. As for the other teacher, HB used 32 facets. The comparison of the teacher facets with the reference list shows that out of MC's 19 facets, 9 (47%) belong to the reference list, and out of HB's 32 facets, only 4 (12%) belong to the reference list.



**Figure 3:** Origin of the facets during the debriefings

These results led us to characterize the continuity of the knowledge used during a teaching sequence on the basis of the number of facets that the student work (lab work) and the debriefing (post lab session) have in common. This continuity, evaluated in terms of facets, was found to be different (as 8% or 43%) according to the teacher. Such a difference forced us to examine in minute detail the new facets used by the teachers.

### 3.3-Concepts Analysis

In the facets used by the teachers during their debriefing, the percentages of concepts important for learning the focal notion of *progress of the reaction* were calculated. These percentages are in the table. In the context of this work, the concepts could be used either at the simulation level (collision, particle and number of particles), at the macroscopic level (chemical transformation, substance, chemical element) or at both levels (initial or final state, progress of the reaction, amount of substance). Having the concept of amount of substance at both levels deserves a comment. At the macroscopic level, it is expressed with the unit of mole whereas at the sub-microscopic one, it is expressed in number of particles. It is therefore not precisely the same concept, and the sub-microscopic aspect of this concept may help to give meaning to the macroscopic aspect which is known to be difficult to learn. It is clear from these percentages (see the table) that MC's and HB's debriefings did not involve the same kind of knowledge. Considering that the student work had been based at the simulation level, MC used the notion of the progress of the reaction at the same sub-microscopic level (44 %) as during the student work with the simulator. HB, on the other hand, used the same concept of the progress of the reaction but at a macroscopic level (8 %). Her discourse dealt rather with the progress of the reaction in the context of the continuation of the teaching sequence, that is, at the macroscopic level (49 %).

**Table:** Percentage of occurrence of the concept connected to the progress of reaction during MC's and HB's debriefing.

	Collision	Particle	Number of particles	Initial state	Final state	Progress of the reaction	Amount of substance	Chemical transformation	Substance	Chemical element
MC	15	22	7	7	4	15	22	4	4	0
HB	4	2	2	8	14	14	7	27	16	6
	Specific to the simulation level			For both levels				Specific to the chemical reaction at the macroscopic level		
MC	44%			48%				8%		
HB	8%			43%				49%		

### 4-Conclusion

To the underlying question of our research project, *what is a debriefing?*, we can now add new information. Debriefing has been introduced above as the time when the teacher comes back to the front of the scene after letting his/her students work under highly autonomous conditions. We now can say that this return to the fore can – or not – use the knowledge at the same level at that used by the students during their work. Our data prove that both cases can happen. We propose to introduce the notion of the limit of the debriefing, which is defined by the fact that the focal concepts are used by the teacher at the same level as during the student work. Beyond this limit, the teacher is no longer debriefing, s/he is continuing the teaching sequence. Within the limit, the students listen to a discourse that uses the same knowledge, at the same level, as during their work in autonomy; beyond this limit, they must adapt their knowledge to a different way of using it.

### 5-References

- Andersson B. (1986-a). The experiential gestalt of causation: A common core to pupils' preconceptions in science. *European Journal of Science Education*, vol.8, p.155–171.
- Cros D., Fayol M., Maurin M., Chastrette, M., Amoureux, R. & Leber, J. (1994). Atome, acides-bases, équilibre. Quelles idées s'en font les étudiants en arrivant à l'université ? *Revue française de pédagogie*, vol.68, p.49-60.
- Driver R., Guesne E. & Tiberghien A. (1985). *Children's Ideas in Science*. Milton Keynes, Open University Press.
- Gabel D. (1998). The complexity of chemistry and implications for teaching. In Fraser B.J. & Tobin K.J. (Eds), *International handbook of science education*. Dordrecht, The Netherlands: Kluwer Academic. P.223-248.
- Gussarsky E. & Gorodetsky M. (1990). On the concept "chemical equilibrium": the associative framework. *Journal of Research in Science Teaching*, vol.27, p.197-204.
- Hesse J.-J. & Anderson C.-W. (1992). Students' conceptions of chemical change. *Journal or Research in Science Teaching*, vol.29, p.277-299.

7. Khanfour-Armalé, R. & Le Maréchal, J.-F. (2009). Teachers' activities for structuring students' knowledge after chemistry laboratory work. *ESERA conference* August 31st - September 4th at Istanbul, Turkey.
8. Le Maréchal J.-F., Khanfour-Armalé R. et Elbilani, R. (in progress). Réaction chimique : modélisation, simulation et bilan de matière, in *Production et utilisation de séquences d'enseignement scientifique pour les jeunes de 11 à 18 ans*, C. BUTY & E. Mortimer Eds.
9. Minstrell J. (1992). Facets of students' knowledge and relevant instruction. In Duit Goldberg, F., Niedderer H. (Ed.), *Research in physics learning: Theoretical issues and empirical studies*, Kiel: IPN. p. 110-128.
10. Nakhleh M.-B. (1992). Why some Students Don't Learn Chemistry. Chemical misconceptions. *Journal of Chemical Education*, vol.69, p.191-196.
11. Stavridou H. & Solomonidou C. (2000). Représentations et conceptions des élèves grecs par rapport au concept d'équilibre chimique. *Didaskalia*, vol.16, p.107-134.
12. Taber K.-S. (1998). An alternative conceptual framework from chemistry education, *International Journal of Science Education*, 20, 597-608.